

# ➤ Instructions

Thule Yepp Mini  
120201



**EN** Child bike seat  
**DE** Fahrradkindersitz  
**FR** Siège vélo enfant  
**NL** Fietszitje  
**IT** Seggiolino da bici  
**ES** Portabebés bici  
**PT** Cadeira de criança para bicicleta  
**SV** Cykelbarnstol  
**DK** Cykelstol  
**NO** Barnesete til sykkel  
**FI** Polkupyörän lastenistuin  
**ET** Jalgratta lasteiste  
**LV** Velosipēda bērnu sēdekļis  
**LT** Dviračio kėdutė vaikams  
**PL** Fotelik rowerowy  
**RU** Детское велосипедное сиденье  
**UK** Дитяче велосипедне крісло  
**BG** Детско столче за велосипед  
**CS** Dětská cyklosedačka  
**SK** Detská cyklosedačka  
**SL** Otroški kolesarski sedež  
**HR/BIH** Dječja sjedalica za bicikl

**RO** Scaun de copii pentru bicicletă  
**HU** Kerékpáros gyerekülés  
**EL** Παιδικό κάθισμα ποδηλάτου  
**TR** Çocuk bisiklet koltuğu

**HE** כיסא אופניים לילד  
**AR** مقعد دراجة الطفل

**ZH** 儿童自行车座椅  
**JA** お子様用サイクルシート  
**KO** 어린이 자전거 시트  
**TH** เก้าอี้เด็กสำหรับจักรยาน

## EN 14344

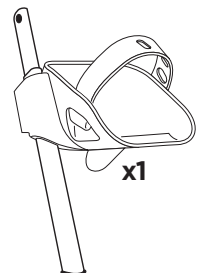
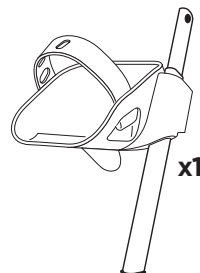
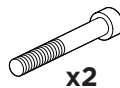
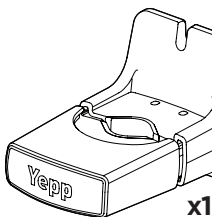
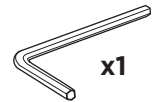
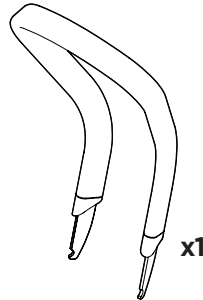
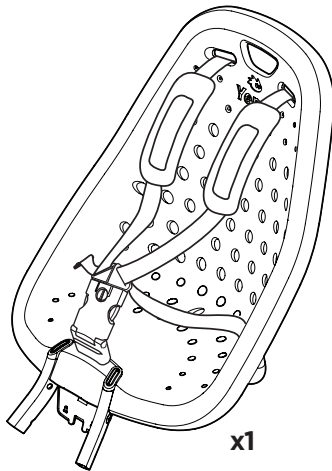
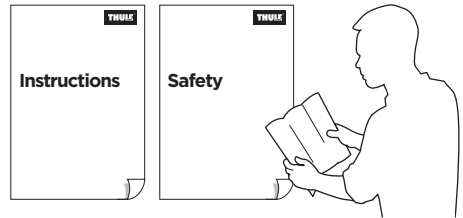



9-36 M  
9-15 kg  
20-33 lbs



Max. 25 km/h  
15 mph

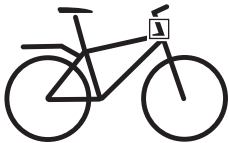
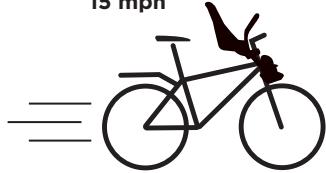

Carbon Fiber Frame

Ø 21-28 mm  
Ø 0.83-1.10"



1

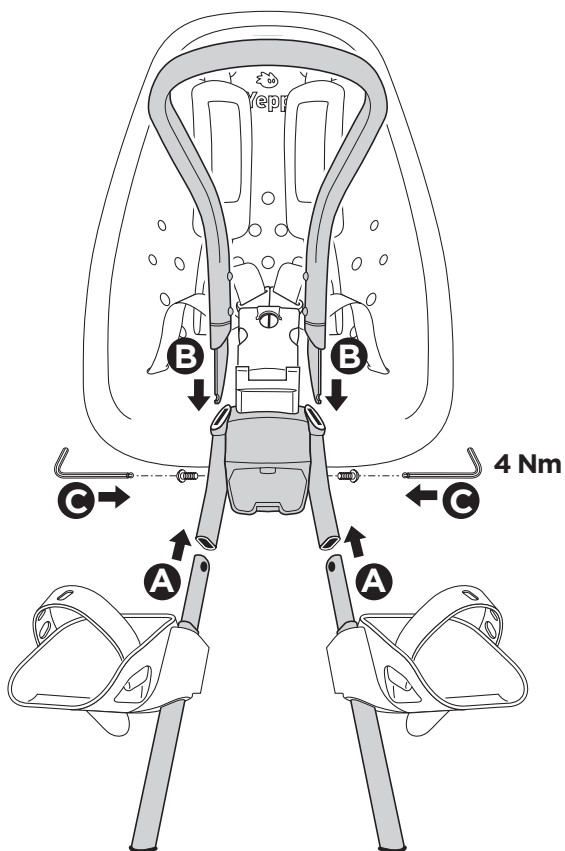

2

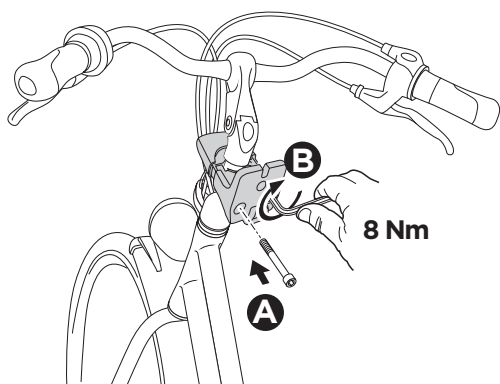

Thule Yepp Mini Ahead  
Adapter: 12020402

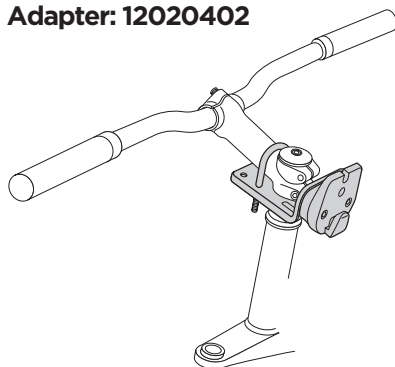

3

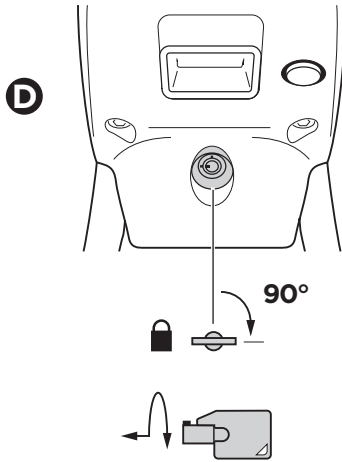
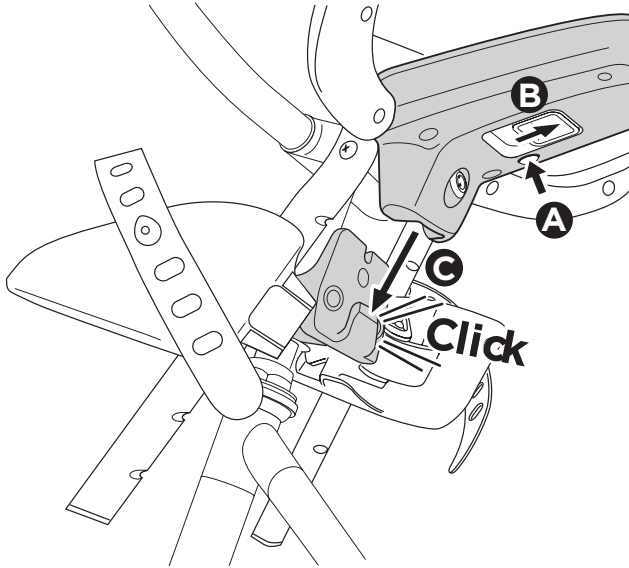

4

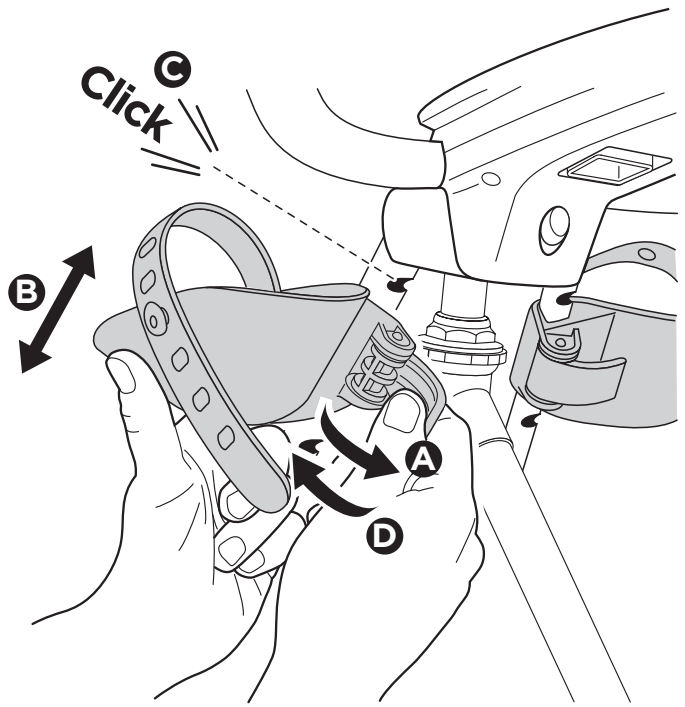

5

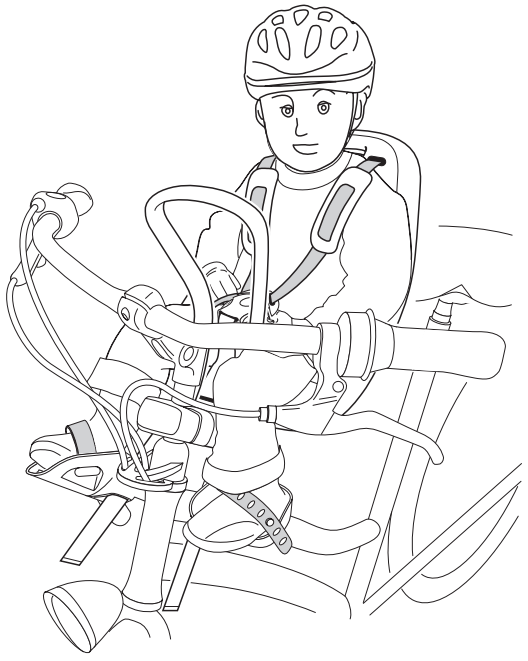
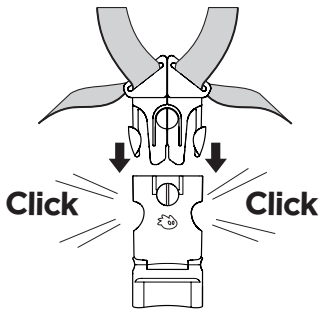

6



<b>EN</b> Accessories	<b>DK</b> Tilbehør	<b>UK</b> Аксессуары	<b>EL</b> Εξαρτήματα
<b>DE</b> Zubehör	<b>NE</b> Tilbehør	<b>BG</b> Принадлежности	<b>TR</b> Aksesuarlar
<b>FR</b> Accessoires	<b>FI</b> Lisävarusteet	<b>CS</b> Doplnky	الملحق <b>AR</b>
<b>NL</b> Accessoires	<b>ET</b> Lisavarustus	<b>SK</b> Príslušenstvo	אביזרים <b>HE</b>
<b>IT</b> Accessori	<b>LV</b> Piederumi	<b>SL</b> Dodatki	<b>ZH</b> 附件
<b>ES</b> Accesorios	<b>LT</b> Priedai	<b>HR/BiH</b> Dodaci	<b>JA</b> アクセサリー
<b>PT</b> Acessórios	<b>PL</b> Akcesoria	<b>RO</b> Accesorii	<b>KO</b> 액세서리
<b>SV</b> Tillbehör	<b>RU</b> Аксессуары	<b>HU</b> Tartozékok	<b>TH</b> อุปกรณ์เสริม

### Thule Yepp Mini SlimFit Adapter 12020413



### Thule Yepp Mini Ahead Adapter 12020402

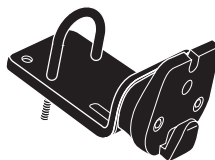

### Thule Yepp Mini Rain Cover 12020961

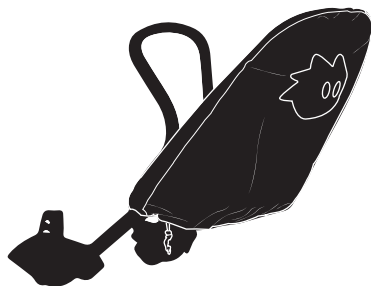

### Thule Yepp Mini Windscreen 12020906

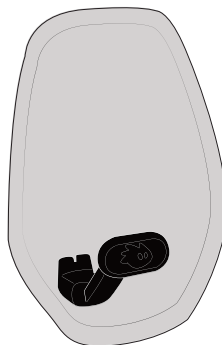

### Thule Yepp Mini Handlebar Padding 12020901



### Thule Yepp Mini Handlebar Padding Miffy 12020902

