



Thule XT Kit 3072

> Instructions

CITROËN Berlingo, 4-dr Van, 08-18

CITROËN Berlingo, 5-dr Van, 08-18

PEUGEOT Partner, 4-dr Van, 08-18

PEUGEOT Partner, 5-dr Van, 08-18

This kit is only for vehicles with fixpoint mounting.

The diagram illustrates the kit's contents and usage. On the left, a silhouette of a person reads instructions. The kit includes two '751 FootPack' and '753 FootPack' (labeled 'A'), a 'Security' manual (labeled 'B'), and two sets of mounting hardware. The hardware sets are specified as follows:

- Set 1: xx kg / xx lbs + 6 kg / 13 lbs = Max. 100 kg / 220 lbs
- Set 2: xx kg / xx lbs + 9 kg / 20 lbs = Max. 150 kg / 330 lbs

On the right, two diagrams show the kit's application. The top diagram shows a side view of a van with three mounting points on the roof rack. The bottom diagram shows a top-down view of a van with a weight distribution diagram. The diagram indicates a maximum weight of 130 kg (90 Mph) and a maximum speed of 80 km/h (50 Mph) for the full load, and 40 km/h (25 Mph) for a partial load. A warning triangle is present in both diagrams.

ISO 11154-E

183072

C.20181024
509-3072-02

Bring your life
thule.com

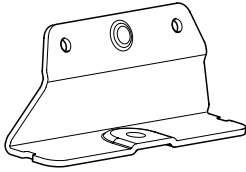

◀ 02 x4

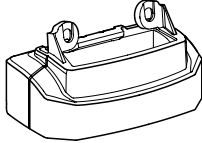

◀ 29 x4

50997

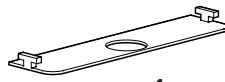

x4

50995



x1



x1



x4

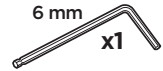

6 mm x1



751
FootPack

A

12 mm x8



x1

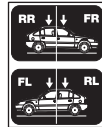

x1

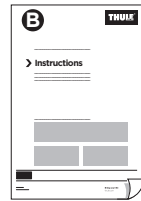

x1



753
FootPack

A

16 mm x8

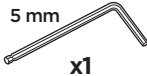

x1

1



x1



x1

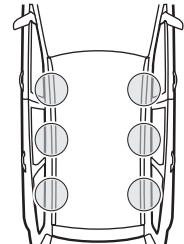
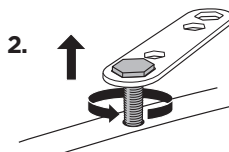
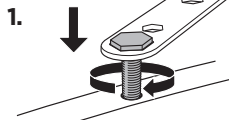

2

751
FootPack

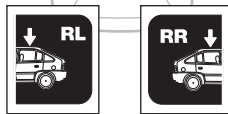
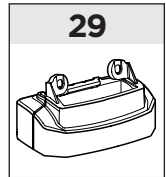
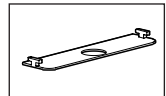
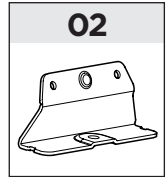
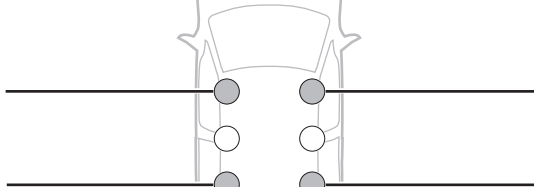
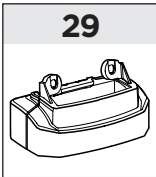
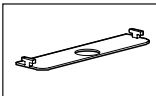
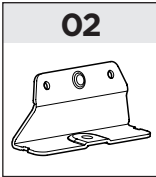
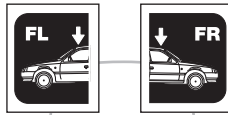
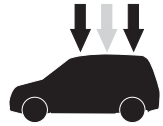

753
FootPack

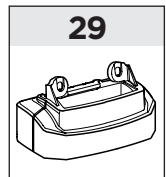
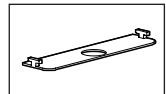
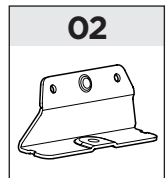
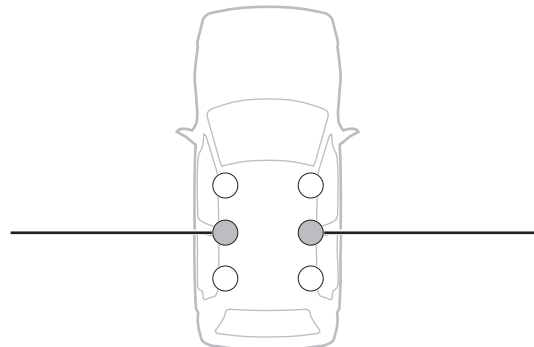
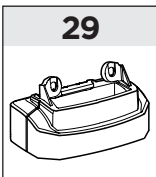
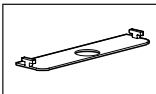
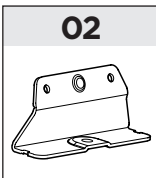
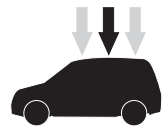

3



751
FootPack

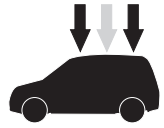

A

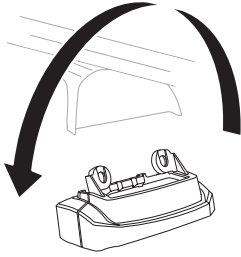

B

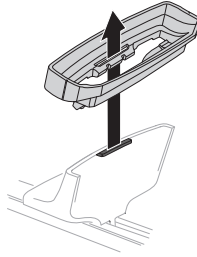

C

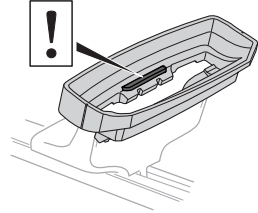

D

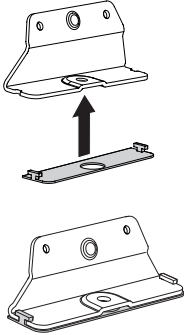

E

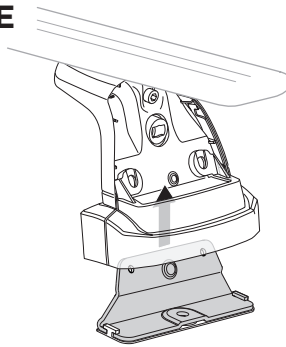

F

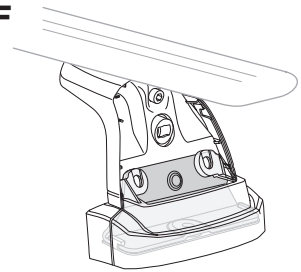

G

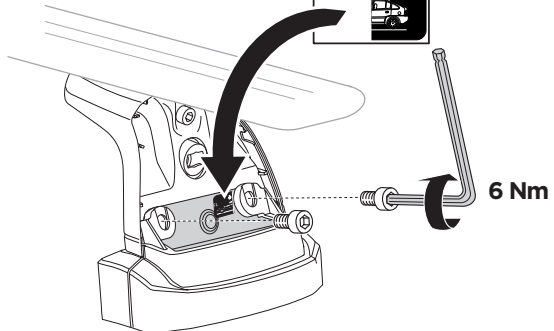
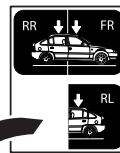
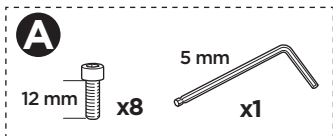

3 753 FootPack

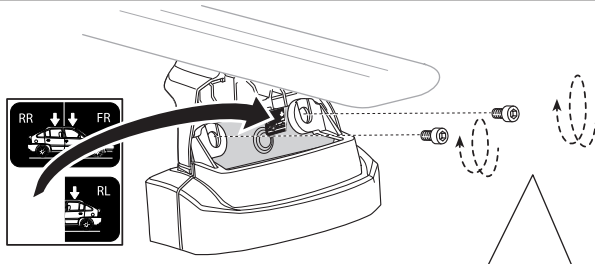
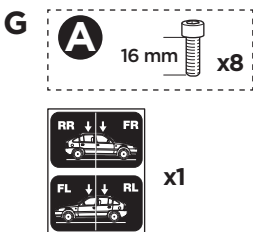
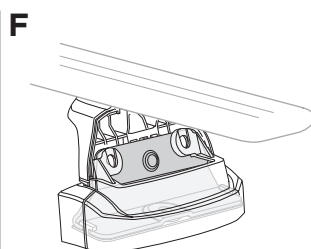
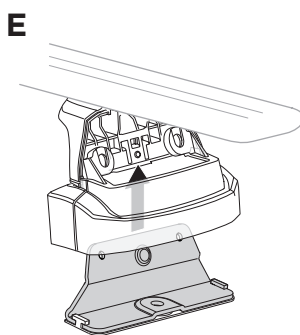
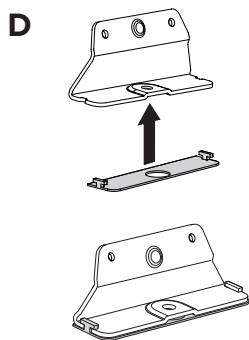
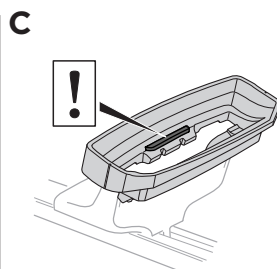
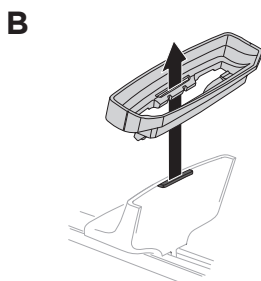
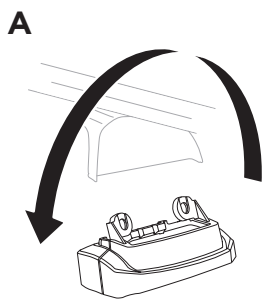
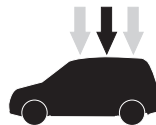

EN Only a few turns
DE Nur wenige Umdrehungen
FR Quelques tours uniquement
NL Slechts enkele slagen
IT Solo qualche giro
ES Sólo algunas vueltas
PT Noções básicas
SV Endast några varv
DK Kun nogle få omgange
NE Bare noen få omdreinger
FI Vain muutama kierros

ET Ainult mõni pööre
LV Tikai daži apgriezieni
LT Tik keli pasukimai
PL Wystarczy kilka obrotów
RU Только несколько оборотов
UK Лише декілька обертів
BG Само няколко завъртания
CS Pouze několik otáček
SK Len niekoľko otáčok
SL Le nekaj obratov
HR/BIH Samo nekoliko okreta

RO Doar câteva rotiri
HU Csak néhány fordítás
EL Μόνο λίγες περιστροφές
TR Yalnızca birkaç tur
ZH 仅几圈
JA 2～3回転のみ
KO 몇 번만 돌리면 됨
TH เพียงสองสามรอบ

AR بعض دورات فقط
 HE רק מספר סיבובים

2

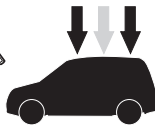
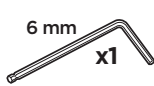
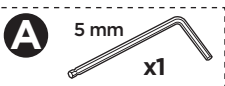

A

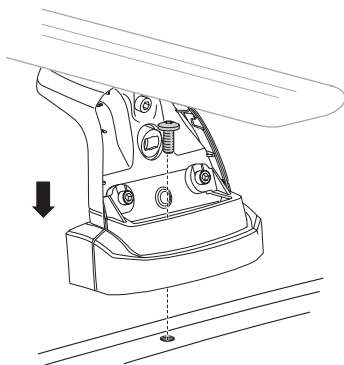
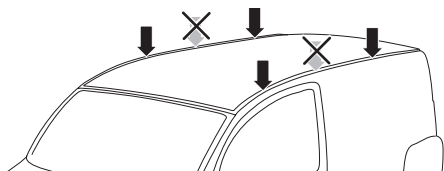

B

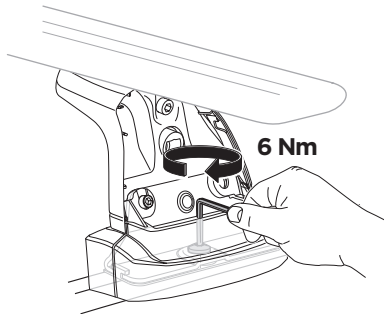
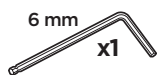

C

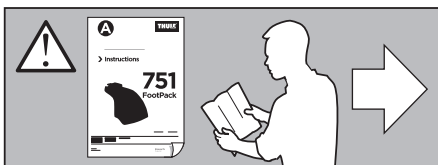
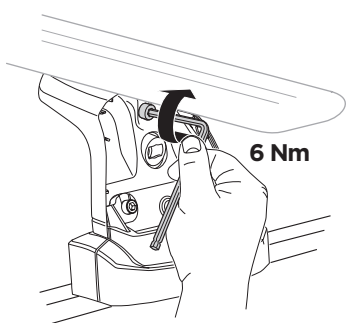
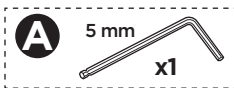

2

753
FootPack

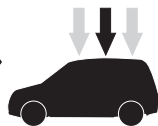
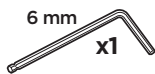
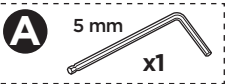

A

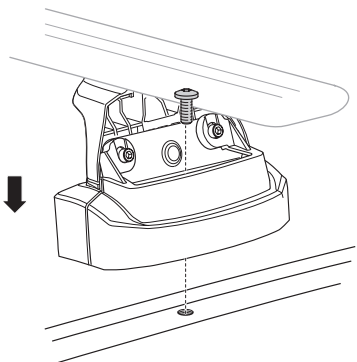
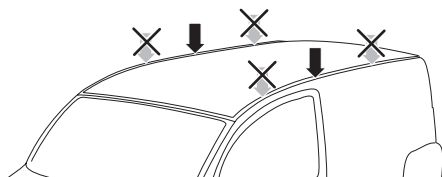

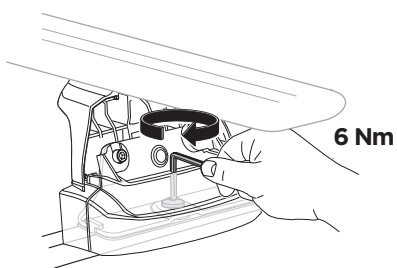
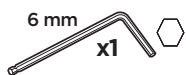

B

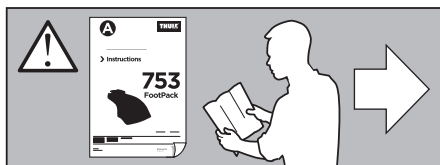
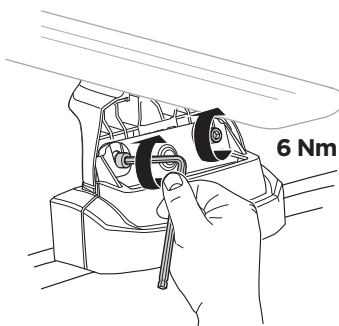
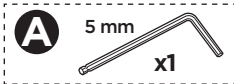

C



WW ▶  Thule Sweden AB, Box 69, 330 33 Hillerstorp, SWEDEN
NA ▶  Thule Inc., 42 Silvermine Road, Seymour, Connecticut 06483, USA

 info@thule.com
 Phone: 800-238-2388

 www.thule.com

› PART OF THULE GROUP

509-3072-02