

**SENA**

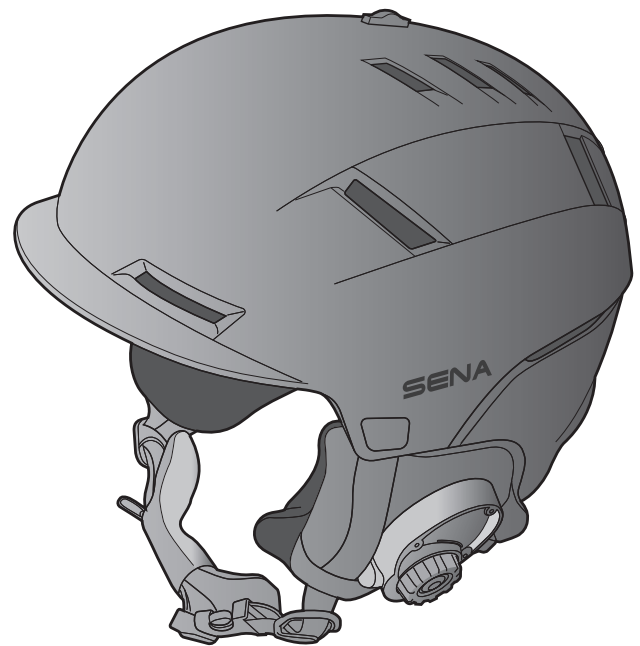

# **LATITUDE S1**

**SMART SNOW HELMET**

**USER'S GUIDE**

# TABLE OF CONTENTS

<b>1.</b>	<b>ABOUT THE LATITUDE S1 SMART SNOW HELMET</b>	<b>4</b>
1.1	General Information	4
1.2	Product Details	5
1.3	Package Contents	5
1.4	Wearing the Helmet	6
1.4.1	How To Fit the Helmet	6
1.4.2	Helmet Fitment Check	8
<b>2.</b>	<b>GETTING STARTED: BLUETOOTH SYSTEM</b>	<b>9</b>
2.1	Downloadable Sena Software	9
2.1.1	Sena Outdoor App	9
2.1.2	Sena Device Manager	9
2.2	Button Function	10
2.3	Powering On and Off	10
2.4	Charging	10
2.5	Checking the Battery Level	11
2.6	Volume Adjustment	11
<b>3.</b>	<b>PAIRING THE BLUETOOTH SYSTEM WITH OTHER BLUETOOTH DEVICES</b>	<b>12</b>
3.1	Phone Pairing	12
3.1.1	Initially Pairing the Latitude S1	12
3.1.2	Pairing When the Latitude S1 Is Turned Off	13
3.1.3	Pairing When the Latitude S1 Is Turned On	14
<b>4.</b>	<b>MOBILE PHONE USAGE</b>	<b>15</b>
4.1	Making and Answering Calls	15
<b>5.</b>	<b>STEREO MUSIC</b>	<b>16</b>
5.1	Using the Stereo Audio Cable	16
5.2	Using the Bluetooth Wireless Stereo	16

<b>6.</b>	<b>BLUETOOTH INTERCOM</b>	<b>17</b>
6.1	Intercom Pairing	17
6.2	Two-Way Intercom	18
6.2.1	HD Intercom	18
6.2.2	Advanced Noise Control™ (Always On)	18
6.3	Multi-Way Intercom	18
6.3.1	Starting a Three-Way Intercom Conference	19
6.3.2	Starting a Four-Way Intercom Conference	19
6.3.3	Ending Multi-Way Intercom	19
6.4	Group Intercom	20
<b>7.</b>	<b>FUNCTION PRIORITY AND FIRMWARE UPGRADES</b>	<b>21</b>
7.1	Function Priority	21
7.2	Firmware Upgrades	21
<b>8.</b>	<b>CONFIGURATION SETTING</b>	<b>22</b>
8.1	Configuration Setting	22
8.1.1	Unit Language	22
<b>9.</b>	<b>TROUBLESHOOTING</b>	<b>23</b>
9.1	Fault Reset	23
9.2	Factory Reset	23
<b>10.</b>	<b>MAINTENANCE AND CARE</b>	<b>24</b>

# 1. ABOUT THE LATITUDE S1 SMART SNOW HELMET

## 1.1 General Information

This product is a snow helmet. Do not use it for any other purpose than snow sports. If you use the helmet for anything else, it may not provide sufficient protection in an accident.

Sena recommends that you choose a helmet which provides the most coverage, as a helmet that covers more of your head may provide additional protection. Make sure the helmet fits comfortably and is tightly fastened at all times.

### **WARNING**

- Your helmet will not protect against injury in all types of accidents. Even while wearing a helmet, low speed accidents may result in serious head injury or death. A helmet will not protect against injuries to the spine, neck or face. In the event of any impact, do not use this helmet. There may be damage invisible to you, which may reduce the ability of the helmet to reduce the harmful effects of a blow to the head. Such helmet should be returned to Sena for inspection, or destroyed and replaced.
- Do not modify or remove any original part of the helmet. Do not use heat damaged helmets. Heat damaged helmets will appear to have uneven or have bubbly surfaces.
- This User's Guide and the stickers inside your helmet contain many instructions and warnings about your helmet. It is important for you to understand everything communicated in them. If you do not, please contact your authorized Sena Retailer with any questions you may have. Failure to follow any of the provided instructions or warnings could void your warranty, and most importantly, could result in severe personal injury or death. If you are a parent or guardian and this helmet is for your child, please take the time to read this manual as you should make sure your child understands everything in this User's Guide.

## 1.2 Product Details

Ventilation Lever

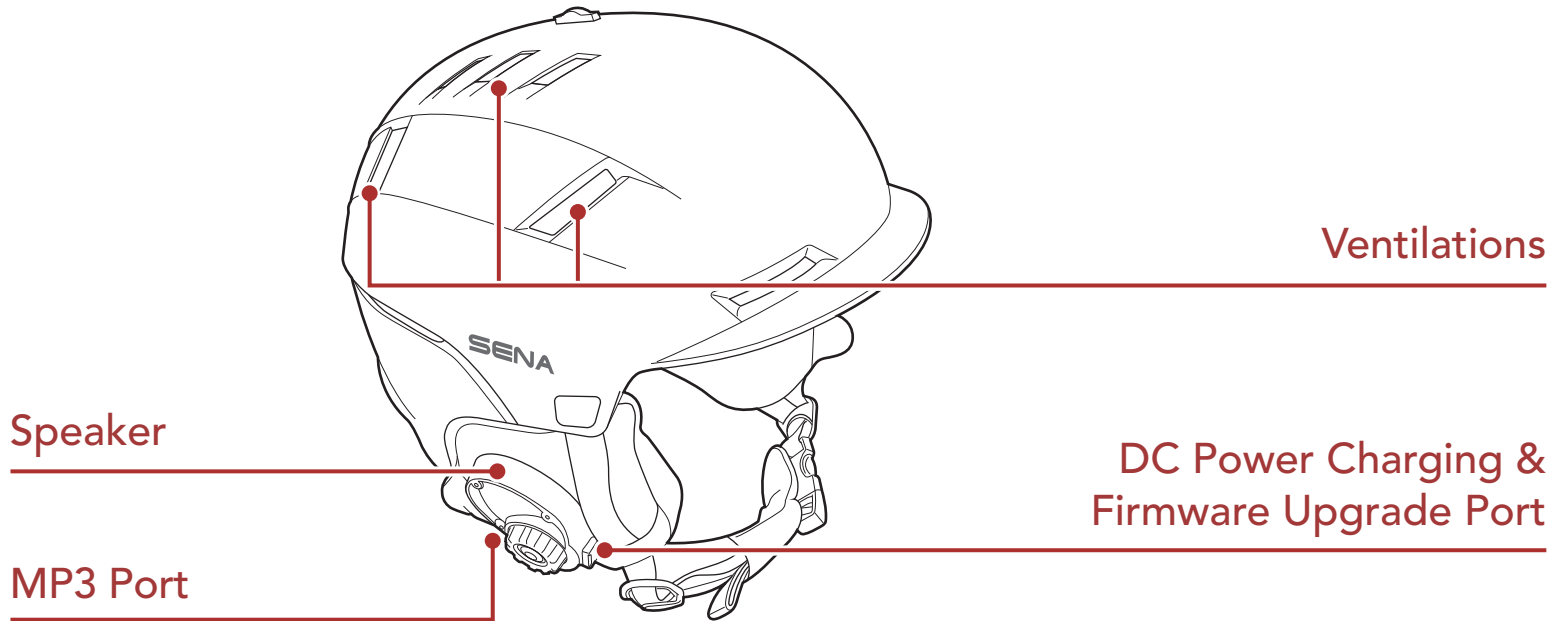
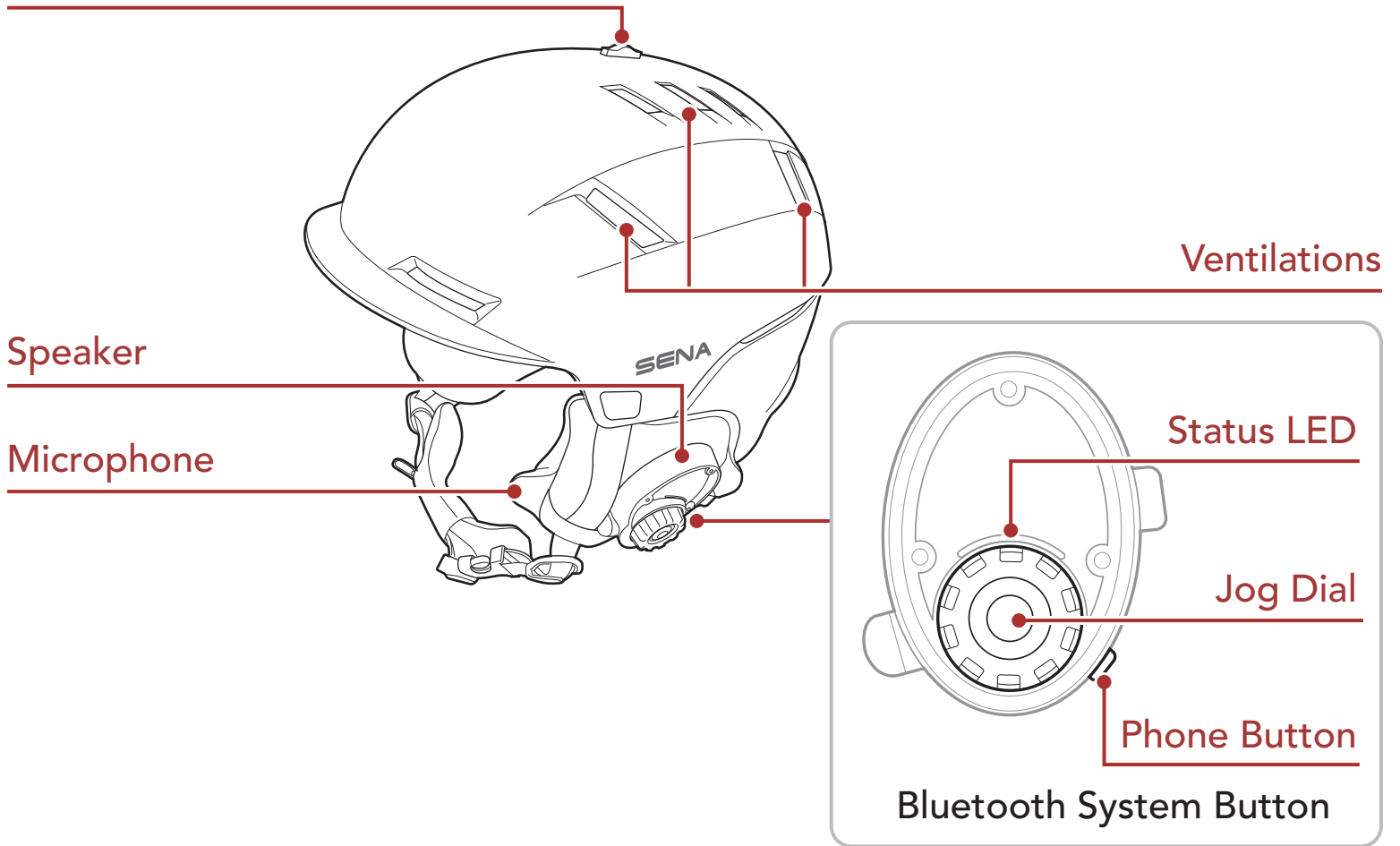

## 1.3 Package Contents

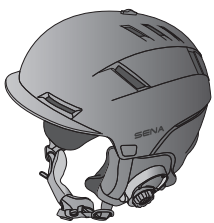

Latitude S1 Helmet



USB Power & Data Cable (USB-C)

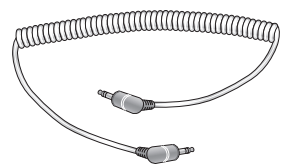

2.5 to 3.5 mm Audio Cable

## 1.4 Wearing the Helmet

### 1.4.1 How To Fit the Helmet

For proper use, the helmet must sit level on the head and low on the forehead. The helmet uses a simple, quick-release buckle system that, once adjusted, can be buckled and unbuckled without changing the tightness. For proper use, the straps must be tight and evenly tensioned.

To properly wear your helmet:

1. Position the helmet on your head with the front covering your forehead. If the helmet is tipped back too far and is not covering your forehead then the helmet is not in the proper position.
2. Position the strap adjuster centered, just below your ears.



**⚠ WARNING:** Always wear the helmet in the proper position on your head with the front of the helmet covering your forehead for maximum protection. Never wear the helmet tipped back as the helmet will be in the improper position causing your forehead to be exposed. All fitment adjustments need to be made with the helmet in the proper position.

3. Position the helmet halfway down on your forehead with the buckle under your chin and back against your throat. The straps should fit comfortably around both of your ears.

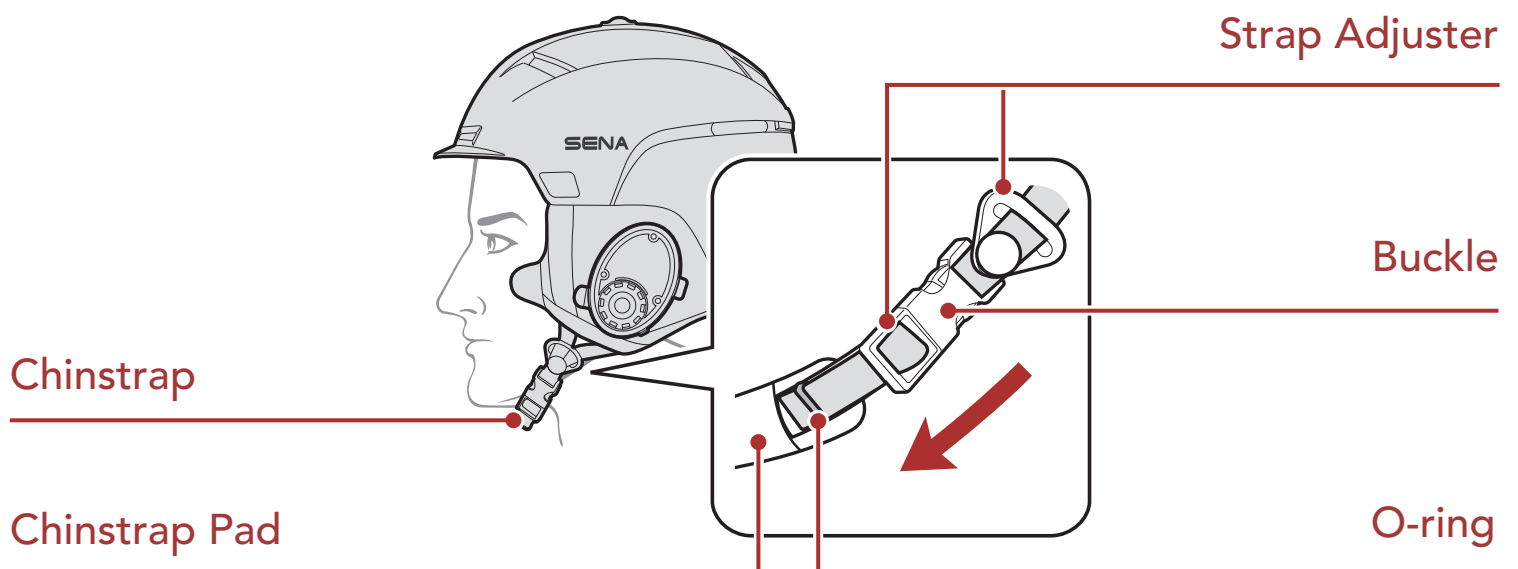

4. After pushing the "Chinstrap Pad" back, adjust the chinstrap tension at the buckle with the strap adjuster in the proper position. Adjust the tension so the chinstrap is tight yet comfortable by pulling the chinstrap end through the buckle to either tighten or loosen the strap as needed.

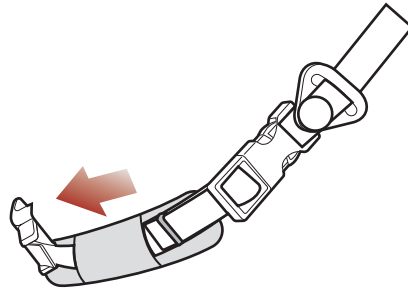

5. Secure the excess strap with the "O-Ring" and then pull the "Chinstrap Pad" again.

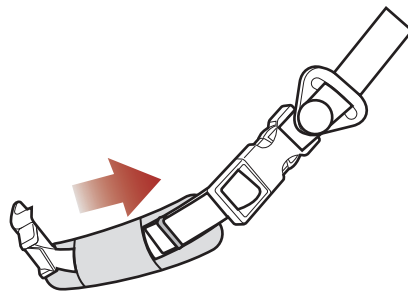

6. Always wear the helmet with the chinstrap buckle fastened and with the chinstrap pulled tight and positioned against the throat. With the strap buckled and the helmet properly positioned, you should feel the chinstrap pull firmly against your chin when you open your mouth. When properly adjusted, the helmet will wrap around your head and cradle it with firm, but comfortable pressure.
7. Try strapping your goggles on. If the helmet is on correctly you won't be able to scratch your forehead.
8. Your helmet is equipped with an adjustable retention system which helps stabilize the helmet in the correct position when you ride. When wearing the helmet, turn the retention system knob clockwise to tighten the helmet or counterclockwise to loosen the helmet.

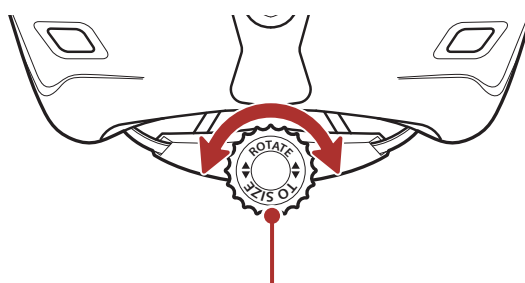

Retention System Knob

**⚠ WARNING:** For maximum protection, this helmet must be fitted and attached properly to the wearer's head in accordance with the following instructions. If after adjustment the helmet does not fit properly, do not use the helmet. Return it to the retailer or Sena.



## 1.4.2 Helmet Fitment Check

With the retention system knob turned clockwise until comfortably tight and the chinstrap buckled under the chin and back against the throat, grab the helmet with both hands and try to remove it by rolling the helmet forward and backward as far as you can. This is an important test to ensure that the helmet fits correctly. When you do this, you should feel the chinstrap pull against the underside of your chin and the helmet will resist any movement. If this isn't the case, tighten the chinstrap and try it again until this happens. If you cannot achieve the proper fit, **DO NOT USE THIS HELMET**. Replace it with a different size until the correct fit is achieved.

Also, for a proper **Helmet Fitment Check** if you can roll the helmet forward such that it blocks your vision or if you can roll the helmet backwards such that your forehead is not covered, tighten the chinstrap and the retention system and try again until you cannot roll the helmet forward or backwards.

### **WARNING**

- Always make sure the buckle is properly fastened before you ride. Failure to follow this instruction could result in serious personal injury, as the helmet may not stay in position while riding or during a fall.
- Check for proper fit and adjustment often, including each time you wear it, and periodically during use.
- This helmet is designed for use by Skiers and Snowboarders. This helmet has not been approved and is not intended for extreme uses such as bicycling, water sports, motor sports, street hockey, playground activities, or other activities where face, ear, or greater protection or coverage is desired.
- Always wear a helmet when skiing and snowboarding. Do not wear a helmet while climbing trees, in play areas, or on playground equipment. Parents: Instruct children to follow this warning. Failure to follow this warning could result in serious personal injury, death or death by strangulation.



## 2. GETTING STARTED: BLUETOOTH SYSTEM

### 2.1 Downloadable Sena Software

#### 2.1.1 Sena Outdoor App

By simply pairing your phone with your Bluetooth system, you can use the **Sena Outdoor App** for quicker, easier setup and management.

- App Features: Music, Device settings, Quick Start Guide, and User's Guide.
- Download
  - Android: Google Play Store > **Sena Outdoor**
  - iOS: App Store > **Sena Outdoor**



#### 2.1.2 Sena Device Manager

The **Sena Device Manager** allows you to upgrade firmware and configure settings directly from your PC. Download the **Sena Device Manager** from [sena.com](https://www.sena.com).

## 2.2 Button Function

### Bluetooth System Buttons

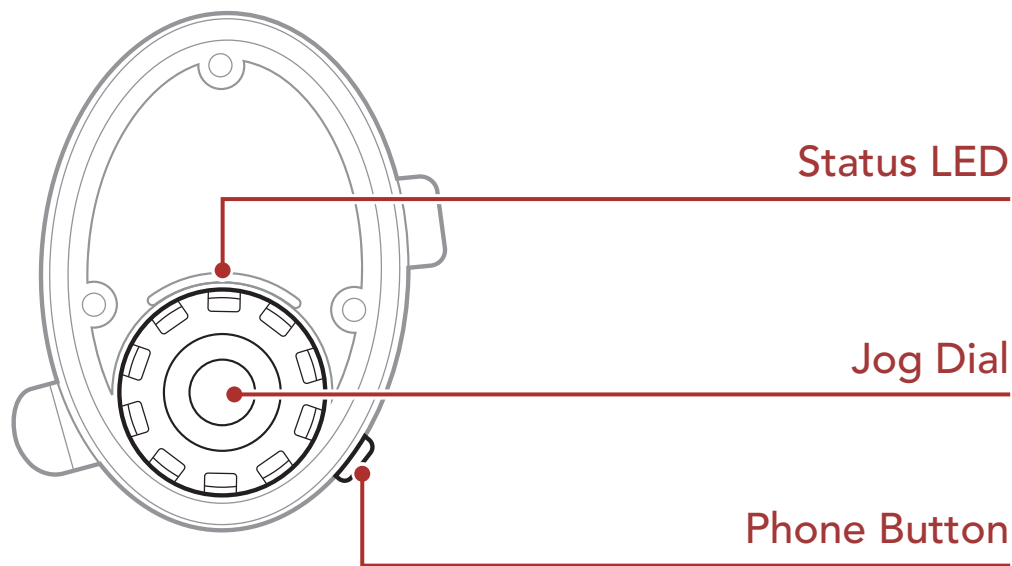

## 2.3 Powering On and Off

### Power On

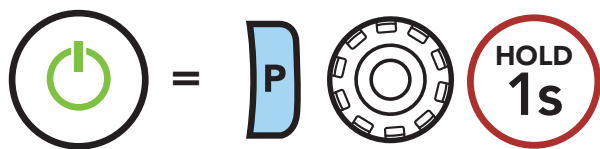

### Power Off

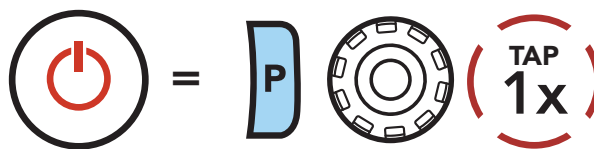

## 2.4 Charging

### Charge the Bluetooth System

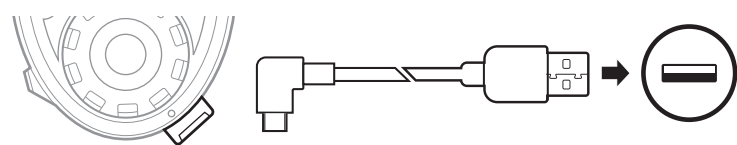

Depending upon the charging method, the Bluetooth system will be fully charged in about 3 hours.

#### Note:

- Please make sure to take off your helmet while charging. The Bluetooth system automatically turns off during charging.
- Any 3rd party USB charger can be used with Sena products if the charger is approved by either the FCC, CE, IC or other locally approved agencies that Sena accepts.
- The Latitude S1 is compatible with 5 V/1 A input USB-charged devices only.

## 2.5 Checking the Battery Level

### Visual Method

Visual method is for when powering the Bluetooth system on.

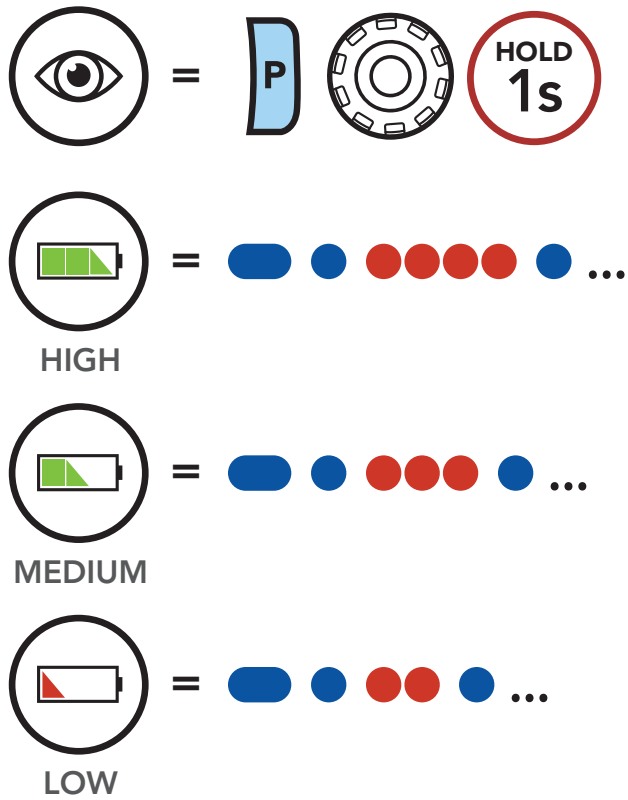

### Audible Method

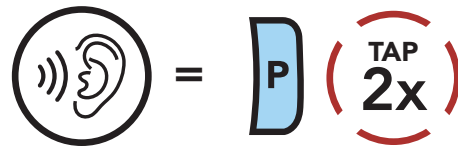

*"Battery level is high/medium/low"*

#### Note:

- The battery performance may be reduced over time with usage.
- Battery life may vary depending on conditions, environmental factors, functions of the product in use, and devices used with it.

## 2.6 Volume Adjustment

Volume is set and maintained independently at different levels for each audio source, even when the Bluetooth system is rebooted.

### Volume Up

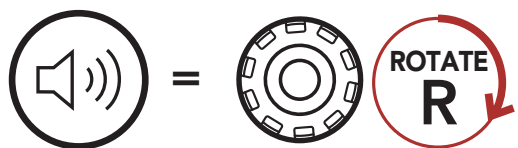

### Volume Down

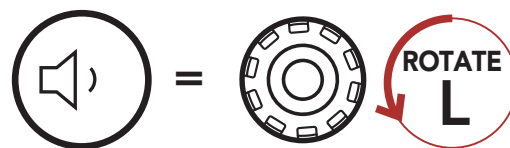

# 3. PAIRING THE BLUETOOTH SYSTEM WITH OTHER BLUETOOTH DEVICES

Before using the Bluetooth system with other Bluetooth devices for the first time, they'll need to be "paired". This enables them to recognize and communicate with one another whenever they're within range. The Bluetooth system can pair with multiple Bluetooth devices such as mobile phone, MP3 player. The pairing operation is required only once for each Bluetooth device.

## 3.1 Phone Pairing

There are three ways to pair the phone.

### 3.1.1 Initially Pairing the Latitude S1

The Bluetooth system will automatically enter the phone pairing mode when you initially turn on the Bluetooth system or in the following situation:

- Rebooting after executing **Factory Reset**

1. Press and hold the **Phone Button** and **Jog Dial** for **1 second**.

#### Phone Pairing

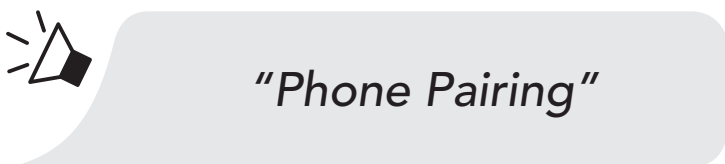
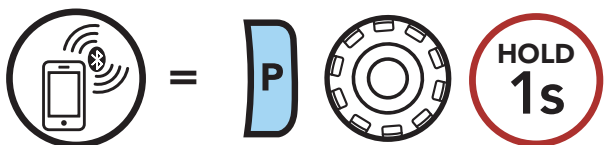

2. With your mobile phone in Bluetooth-pairing mode, select **Latitude S1** in the list of devices detected.

3. If your mobile phone asks for a PIN, enter 0000.

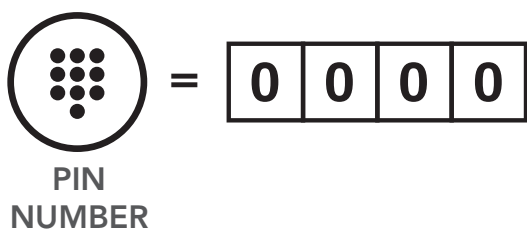

**Note:**

- The phone pairing mode lasts for **3 minutes**.
- To cancel pairing, tap the **Phone Button** or **Jog Dial**.

### 3.1.2 Pairing When the Latitude S1 Is Turned Off

1. While the **Latitude S1** is off, press and hold the **Phone Button** and **Jog Dial** for **5 seconds**.

**Phone Pairing**

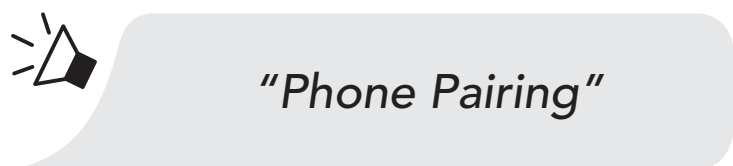
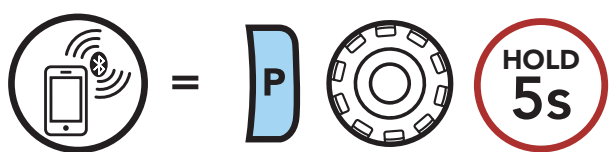

2. With your mobile phone in Bluetooth-pairing mode, select **Latitude S1** in the list of devices detected.

3. If your mobile phone asks for a PIN, enter 0000.

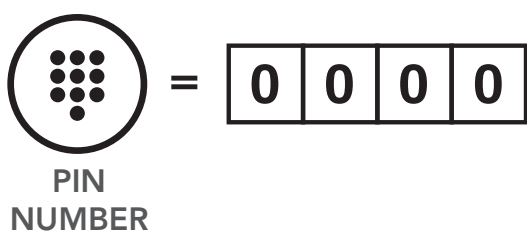

### 3.1.3 Pairing When the Latitude S1 Is Turned On

1. While the **Latitude S1** is on, press and hold the **Phone Button** for **5 seconds**.

#### Phone Pairing

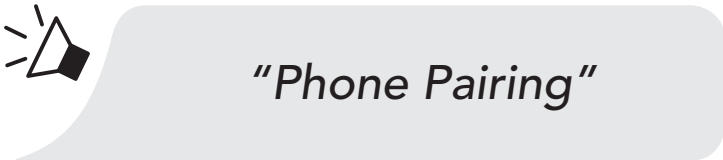
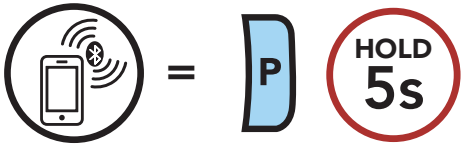

2. With your mobile phone in Bluetooth-pairing mode, select **Latitude S1** in the list of devices detected.
3. If your mobile phone asks for a PIN, enter 0000.

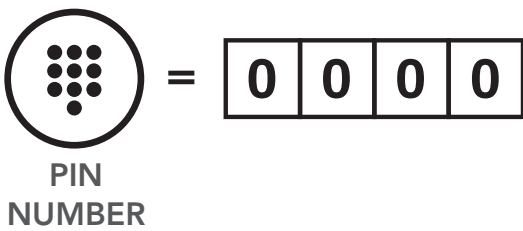

# 4. MOBILE PHONE USAGE

## 4.1 Making and Answering Calls

### Answer a Call

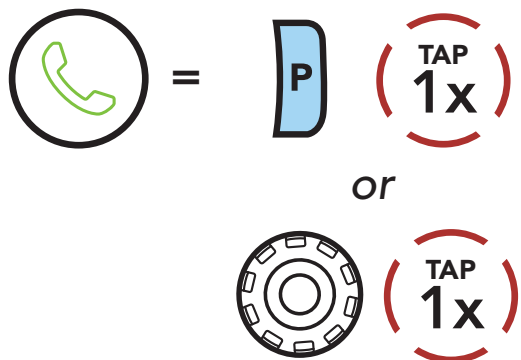

### Make a Call with the Voice Dialer

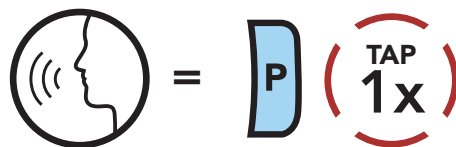

### End a Call

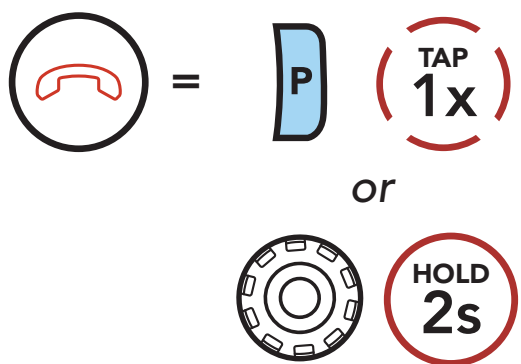

### Reject a Call

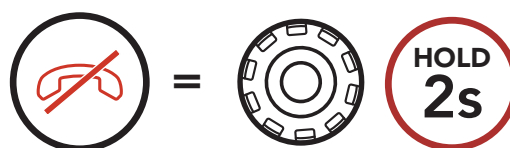



# 5. STEREO MUSIC

You can listen to stereo music in two ways: with the enclosed stereo audio cable or by Bluetooth wireless stereo.

## 5.1 Using the Stereo Audio Cable

You can play music that is stored on non-Bluetooth devices such as MP3 players. To connect your device to the headset, plug the enclosed 2.5 to 3.5 mm audio cable into the AUX ports, both on the headset and on your device.

To adjust the volume, rotate the **Jog Dial** on the Bluetooth system. You can also adjust the volume on the MP3 player.

## 5.2 Using the Bluetooth Wireless Stereo

### Play/Pause Music

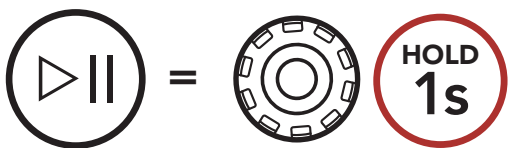

### Next Track

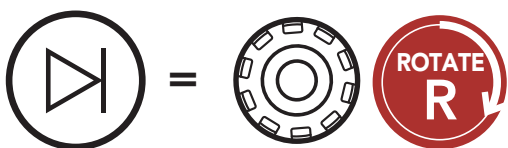

### Previous Track

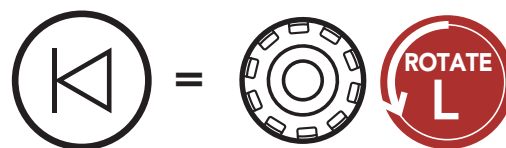

# 6. BLUETOOTH INTERCOM

## 6.1 Intercom Pairing

Up to three other people can be paired with the Bluetooth system for Bluetooth intercom conversations.

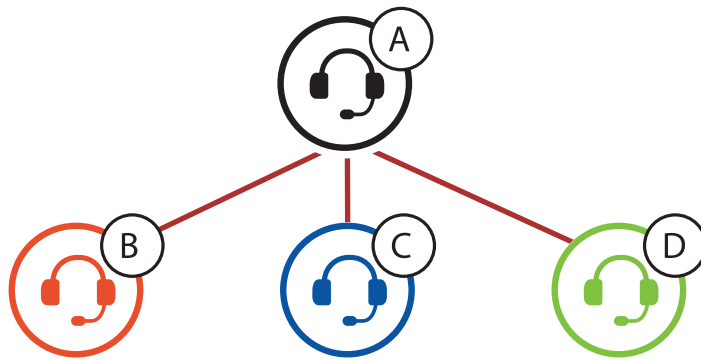

1. Press and hold the **Jog Dial** of two Bluetooth systems for **5 seconds** until flashes red.
2. Tap the **Jog Dial** on either Bluetooth system and wait until the LEDs of both turn blue.

### Pairing with Intercom B

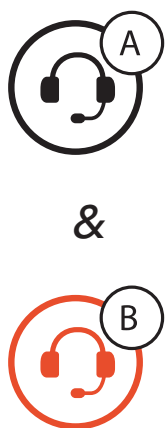

### On Either One of the Devices

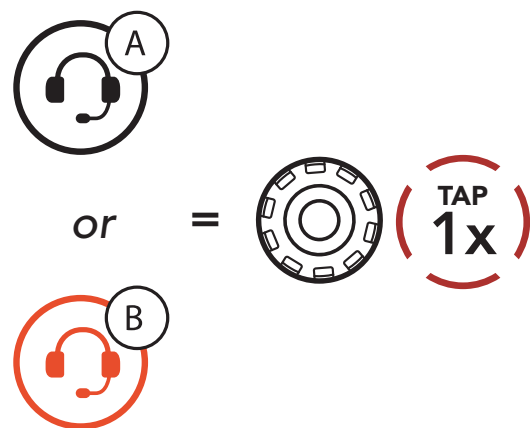

3. Repeat steps 1 and 2 to pair with **Intercom Friends C & D**.

### Last-Come, First-Served

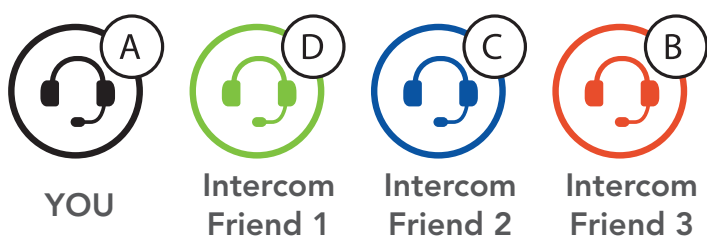

## 6.2 Two-Way Intercom

You can start or end an intercom conversation with an **Intercom Friend** by tapping the **Jog Dial**.

### Start/End Two-Way Intercom with Intercom Friend 1,2,3

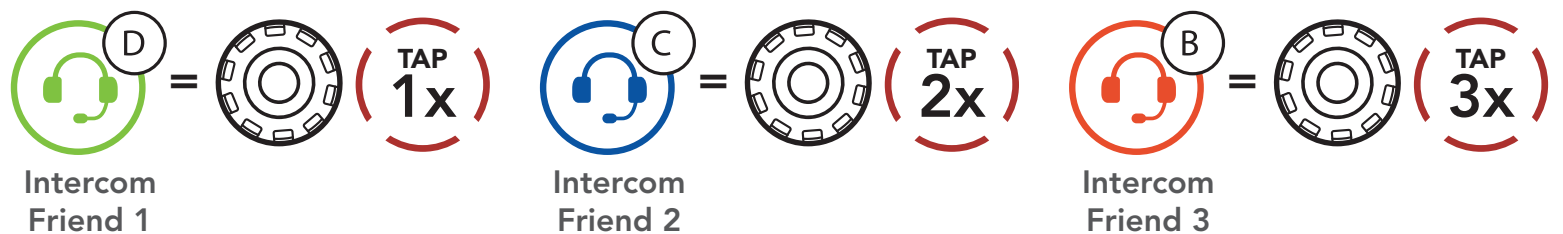

### 6.2.1 HD Intercom

HD Intercom enhances the two-way intercom audio from normal quality to HD quality. When you enter into a multi-way intercom, HD Intercom will be automatically disabled. If this feature is disabled, the intercom audio will change to normal quality.

- HD intercom is only active for two-way intercom.

### 6.2.2 Advanced Noise Control™ (Always On)

The background noise is reduced during an intercom conversation.

## 6.3 Multi-Way Intercom

**Multi-Way Intercom** enables conference-call-style conversations with up to **three Intercom Friends** at the same time. While **Multi-Way Intercom** is in progress, mobile phone connection is temporarily disconnected. However, as soon as **Multi-Way Intercom** terminates, the mobile phone connection will be reestablished.

### 6.3.1 Starting a Three-Way Intercom Conference

**You (A)** can have a **Three-Way Intercom Conference** with two other **Intercom Friends (B & C)** by establishing two intercom connections simultaneously.

1. You (A) need to be paired with two other **Intercom Friends (B & C)** for three-way conference intercom.
2. Start an intercom conversation with one of the two friends in your intercom group.
3. You (A) can call the **second Intercom Friend (C)** by double tapping the **Jog Dial**, or the **second Intercom Friend (C)** may join the intercom by making an intercom call to you (A).

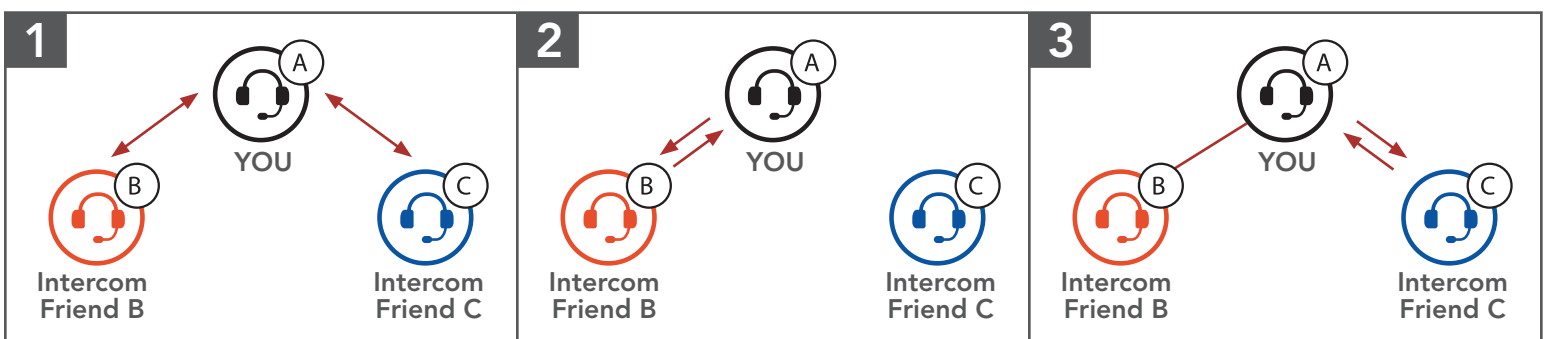

### 6.3.2 Starting a Four-Way Intercom Conference

With **three Intercom Friends** connected, a new participant (**D**) can make it a **Four-Way Intercom Conference** by making an intercom call to either (**B**) or (**C**).

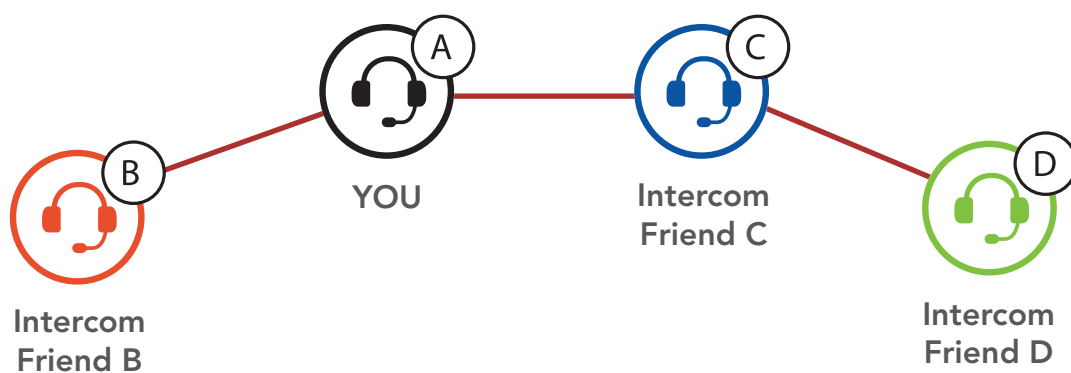

### 6.3.3 Ending Multi-Way Intercom

1. Press and hold the **Jog Dial** for **1 second** until you hear a beep to terminate all intercom connections.
2. Tap the **Jog Dial** to disconnect from your **first Intercom Friend**. Double tap the **Jog Dial** to disconnect from your **second Intercom Friend**.

## 6.4 Group Intercom

**Group Intercom** allows you to instantly create a **Multi-Way Conference Intercom** with three of the most recently paired headsets.

Go through intercom pairing with up to three people you want in the Group Intercom.

### Start Group Intercom

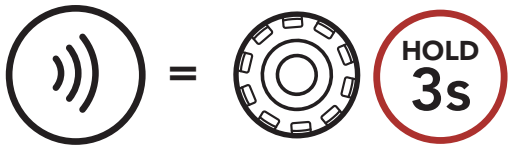

### Terminate Group Intercom

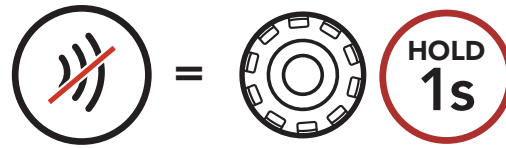

# 7. FUNCTION PRIORITY AND FIRMWARE UPGRADES

## 7.1 Function Priority

The Bluetooth system operates in the following order of priority:

- (highest)** Mobile phone
- Intercom
- (lowest)** Bluetooth stereo music

A lower priority function is always interrupted by a higher priority function.

## 7.2 Firmware Upgrades

The Bluetooth system supports firmware upgrades. You can upgrade the firmware using the **Sena Device Manager**. Please visit [sena.com](https://www.sena.com) to check for the latest software downloads.

[Click Here to Visit sena.com](https://www.sena.com)

# 8. CONFIGURATION SETTING

## 8.1 Configuration Setting

You can change the settings of the Bluetooth system through the **Sena Device Manager** or the **Sena Outdoor App**.

### 8.1.1 Unit Language

You can select the device language. The selected language is maintained even when the Bluetooth system is rebooted.



# 9. TROUBLESHOOTING

## 9.1 Fault Reset

When the USB charging & data cable connects a power supply to the Bluetooth system, the Bluetooth system will automatically be turned off and a fault reset will occur.

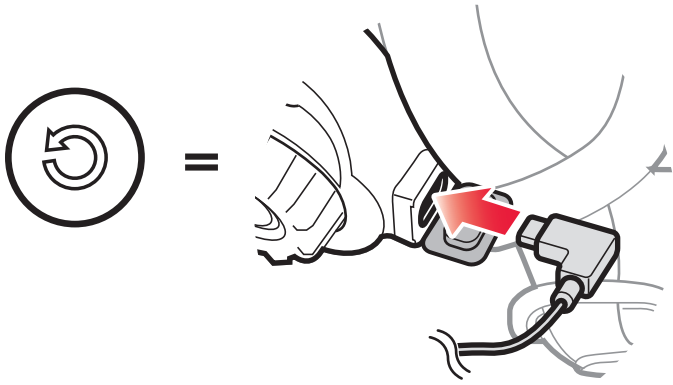

**Note: Fault Reset** will not restore the Bluetooth system to the factory default settings.

## 9.2 Factory Reset

To erase all of your settings and start fresh, the Bluetooth system can be restored to factory default settings using the factory reset.

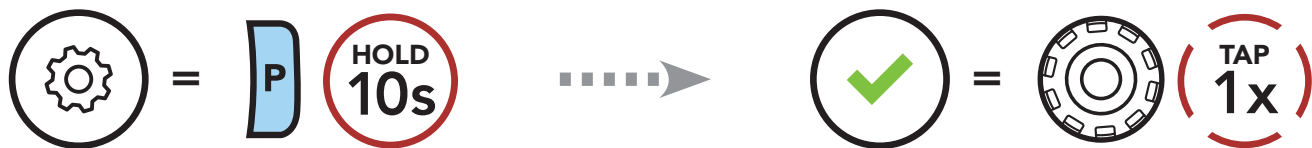

## 10. MAINTENANCE AND CARE

The inner lining of the helmet is completely removable. Its headliner can be washed by hand using only water, mild soap, at a maximum temperature of 30°C (86°F), and non-abrasive cloths to clean the helmet's shell, pads and retention system. Allow the padding to dry at room temperature. Store the helmet in a dry, dark, well-ventilated location, out of the reach of children and animals. High temperatures (above 110°F, 43°C) may melt the helmet's shell.

### **WARNING**

- Never use gasoline, diesel fuel, thinners or solvents to clean the helmet. These substances can cause serious damage to the helmet, even though the resulting damage may not be visible. This helmet can be damaged by contact with common substances (for example, certain solvents (ammonia), cleaners (bleach), paints, abrasives) and this damage may not be visible to the wearer. Do not use this helmet if it has been exposed to such substances. The full safety function of the helmet can no longer be guaranteed if exposed to damaging substances.
- Do not store your helmet in your car or anywhere else near a heat source. Do not use if the shell has been melted or deformed. Always position the helmet so that it cannot fall to the floor. Damage that occurs in this way is not covered by the warranty.
- Do not attach anything to your helmet, including mirrors or lights.

Ventilation holes may allow harmful objects to pass in the helmet interior.

The protective capability of your helmet will diminish over time, dependent upon many factors such as dents, dings, and exposure to pollution, harmful chemicals and long term exposure to the sun. Sena recommends that helmets be replaced after five years.

**Note:** The useful life of your helmet may be less than five years as a result of exposure to sunlight, rough, handling/storage that results in dents or cuts or as a result of heavy use.



Copyright © 2020 Sena Technologies, Inc.  
All rights reserved.

© 1998–2020 Sena Technologies, Inc. All rights reserved.

Sena Technologies, Inc. reserves the right to make any changes and improvements to its product without providing prior notice.

Sena™ is a trademark of Sena Technologies, Inc. or its subsidiaries in the USA and other countries. SF1™, SF2™, SF4™, SFR™, SRL™, Momentum™, Momentum INC™, Momentum Lite™, Momentum Pro™, Momentum INC Pro™, Momentum EVO™, Cavalry™, Latitude SR™, Latitude SX™, Latitude S1™, 30K™, 50S™, 50R™, 5S™, 20S EVO™, 20S™, 10S™, 10C™, 10C PRO™, 10C EVO™, 10U™, 10Upad™, 10R™, 3S™, 3S PLUS™, SMH5™, SMH5-FM™, SMH5 MultiCom™, SMH10™, SMH10R™, SPH10™, SPH10H-FM™, Savage™, Prism Tube WiFi™, Prism™, Bluetooth Audio Pack for GoPro®, R1™, R1 EVO™, R1 EVO CS™, M1™, M1 EVO™, RC1™, RC3™, RC4™, Handlebar Remote™, Wristband Remote™, PowerPro Mount™, Powerbank™, FreeWire™, WiFi Docking Station™, WiFi Sync Cable™, WiFi Adapter™, +Mesh™, +Mesh Universal™, MeshPort Blue™, MeshPort Red™, Econo™, OUTRUSH™, OUTSTAR™, EcoCom™, Parani M10™, SR10™, SR10i™, SM10™, X1™, X1 Pro™, X1S™, Expand™, Bluetooth Mic & Intercom™, Tufftalk™, Tufftalk Lite™, Tufftalk M™ are trademarks of Sena Technologies, Inc. or its subsidiaries. These trademarks may not be used without the express permission of Sena.

GoPro® is a registered trademark of Woodman Labs of San Mateo, California. Sena Technologies, Inc. ("Sena") is not affiliated with Woodman Labs, Inc. The Sena Bluetooth Pack for GoPro® is an aftermarket accessory specially designed and manufactured by Sena Technologies, Inc. for the GoPro® Hero3 and Hero4 allowing for Bluetooth capabilities.

The Bluetooth® word mark and logos are owned by the Bluetooth SIG, Inc. and any use of such marks by Sena is under license. iPhone® and iPod® touch are registered trademarks of Apple Inc.

Address: 152 Technology Drive Irvine, CA 92618