

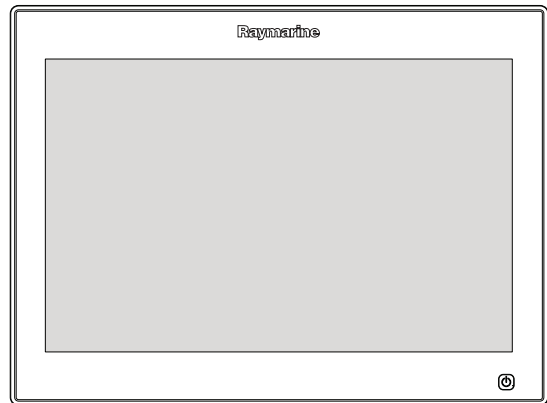

gS Series



Installation and operation instructions

English

Date: 10-2014

Document number: 81344-6-EN

© 2014 Raymarine UK Limited

Document and software changes

The following tables describe the main changes that have been made since the last release of both the product software and this document.

- **Applicable software version:** LightHouse II — Release 12.xx
- **Applicable documents:** 81344–6
- **Applicable products:** gS95 / gS125 / gS165 / gS195.

Document and Software changes

Description	Applicable application	Applicable chapter(s) or section(s)
Added support for up to 2 Radar scanners on the same network.	Radar application	<ul style="list-style-type: none"> • 21.2 Multiple radar scanners <ul style="list-style-type: none"> – Using the power button to switch operating modes • 3.1 System integration
Added support for displaying up to 4 camera feeds using Quad View.	Camera application	<ul style="list-style-type: none"> • 22.3 Displaying multiple camera feeds using Quad View
Added 'Battery Charge' data item and changed 'RPM & Speed' data item to 'RPM & SOG' in the Data application.	Data application	<ul style="list-style-type: none"> • 9.7 List of data items
Increased support for number of batteries to 16.	System	<ul style="list-style-type: none"> • 9.2 Boat details

Software changes

Description	Applicable application	Applicable chapter(s) or section(s)
Added support in the Radar application for extreme latitudes up to 82 degrees north.	Radar application	N/A

For a full software version history including a list of applicable **MFD** variants for each version, refer to:

- [Appendix E Software release history](#).

Document changes

Description	Applicable application	Applicable chapter(s) or section(s)
Updated power consumption figures for. Added Standby power consumption figures.	N/A	<ul style="list-style-type: none"> • Chapter 31 Technical specification <ul style="list-style-type: none"> – Power specification
Updated Powering Off instructions to reflect gS Series is placed in standby mode when turned off using power button and will still consume power.	N/A	<ul style="list-style-type: none"> • 6.1 Display power <ul style="list-style-type: none"> – Putting the display into Standby
Updated PowerSave mode section to include caution that in PowerSave mode power will still be consumed by the unit. The term Standby has also been removed from the title to ensure it is differentiated from gS Series standby mode.	N/A	<ul style="list-style-type: none"> • PowerSave mode
Added internal storage table to Technical Specification, detailing available internal storage for each MFD variant.	N/A	<ul style="list-style-type: none"> • Internal storage
Added popular features table to Camera application overview and example recording times for CAM200IP to Record and playback section.	Camera application	<ul style="list-style-type: none"> • 22.1 Camera application overview and features • 22.9 Record and playback <ul style="list-style-type: none"> – Approximate record times
Added Panoramic photo and 2D shading to list of disabled overlays / object when Chart detail is set to low.	Chart application	<ul style="list-style-type: none"> • 18.13 Cartography objects <ul style="list-style-type: none"> – Chart detail
Updated list of settings which can be backed-up / restored.	N/A	<ul style="list-style-type: none"> • 8.5 Save and restore items

Description	Applicable application	Applicable chapter(s) or section(s)
Changed IP camera connections section to show the ethernet coupler instead of the cross over coupler and added parts numbers for adaptor cable and ethernet coupler.	N/A	<ul style="list-style-type: none"> • 4.12 IP Camera connections
Added IP camera guidance to IP Camera connection section.	N/A	<ul style="list-style-type: none"> • IP camera guidance
Added details for Interpreting SideVision™ images to the Sonar technologies section of the Fishfinder chapter.	N/A	<ul style="list-style-type: none"> • 19.2 Sonar technologies <ul style="list-style-type: none"> – Interpreting SideVision™ images
Updated Appendix — NMEA 2000 sentences to reflect LightHouse II V12.xx supported PGN's.	N/A	<ul style="list-style-type: none"> • Appendix C NMEA 2000 sentences

Trademark and patents notice

Raymarine, Tacktick, Clear Pulse, Truzoom, HSB, SeaTalk, SeaTalk^{hs}, SeaTalk^{ng}, Micronet, Raytech, Gear Up, Marine Shield, Seahawk, Autohelm, Automagic, and Visionality are registered or claimed trademarks of Raymarine Belgium.

FLIR, DownVision, SideVision, Dragonfly, Instalert, Infrared Everywhere, and The World's Sixth Sense are registered or claimed trademarks of FLIR Systems, Inc.

All other trademarks, trade names, or company names referenced herein are used for identification only and are the property of their respective owners.

This product is protected by patents, design patents, patents pending, or design patents pending.

Fair Use Statement

You may print no more than three copies of this manual for your own use. You may not make any further copies or distribute or use the manual in any other way including without limitation exploiting the manual commercially or giving or selling copies to third parties.

Software updates

Check the website www.raymarine.com for the latest software releases for your product.

Product handbooks

The latest versions of all English and translated handbooks are available to download in PDF format from the website www.raymarine.com.



Please check the website to ensure you have the latest handbooks.

Copyright ©2014 Raymarine UK Ltd. All rights reserved.

Contents

Chapter 1 Important information.....	9	4.6 Auxiliary alarm connection	51
Certified Installation	9	4.7 Network connections	52
Product operation in high temperatures	10	4.8 Keypad connection.....	54
Power over Ethernet (PoE).....	11	4.9 Radar connection.....	55
TFT Displays	11	4.10 Sonar module connection	57
Water ingress	11	4.11 Thermal camera connection	59
Disclaimers	11	4.12 IP Camera connections	60
Memory cards and chart cards	12	4.13 Weather receiver connection.....	61
EMC installation guidelines	12	4.14 Fusion link connection	61
RF exposure	12	4.15 GPS connection	62
FCC.....	12	4.16 AIS connection.....	63
Compliance Statement (Part 15.19)	12	4.17 Fastheading connection.....	63
FCC Interference Statement (Part 15.105 (b))	12	4.18 SeaTalk ^{ng} connections	64
Industry Canada	13	4.19 NMEA 2000 connection	65
Industry Canada (Français)	13	4.20 SeaTalk connection	65
Japanese approvals.....	13	4.21 NMEA 0183 connection	66
Third party software license agreements	13	4.22 Camera / Video connections	67
Suppression ferrites	13	4.23 HDMI video output	67
Connections to other equipment	14	4.24 HD-SDI connection (gS195).....	68
Declaration of conformity.....	14	4.25 Media player connection.....	69
Product disposal.....	14	4.26 Bluetooth remote control connection.....	70
Pixel defect policy	14	4.27 Remote control functions	72
Warranty registration.....	14	4.28 WiFi connections.....	74
IMO and SOLAS.....	14	Chapter 5 Mounting.....	75
Technical accuracy	14	5.1 Bracket mounting hole locations.....	76
Chapter 2 Document and product information.....	15	5.2 Mounting surface requirements	76
2.1 Handbook information	16	5.3 Flush mounting the display	77
2.2 Handbook conventions	17	5.4 Flush mounting the card reader.....	78
2.3 Product overview	19	5.5 Surface mounting the display	79
2.4 System feature highlights.....	20	5.6 Surface mounting the card reader	80
Chapter 3 Planning the installation	27	Chapter 6 Getting started	81
3.1 System integration	28	6.1 Display power	82
3.2 Installation checklist	33	6.2 Controls.....	83
3.3 Multiple data sources (MDS) overview	33	6.3 Homescreen overview — Touch only displays	85
3.4 Identifying your display variant	34	6.4 Pages	87
3.5 Networking constraints	34	6.5 Applications	88
3.6 Typical systems	36	6.6 Splitscreen controls.....	89
3.7 System protocols	38	6.7 Screen overview	90
3.8 Data master.....	39	6.8 Basic touchscreen operations	93
3.9 Parts supplied.....	39	6.9 Multi-Touch gestures	94
3.10 Tools required for installation.....	40	6.10 Initial set up procedures.....	94
3.11 Selecting a location	41	6.11 Enabling autopilot control.....	97
Chapter 4 Cables and connections.....	45	6.12 Engine identification	98
4.1 General cabling guidance	46	6.13 Enabling AIS functions.....	100
4.2 gS95 / gS125 / gS165 Connections overview	47	6.14 Shared preferences.....	100
4.3 gS195 connections overview.....	47	6.15 Software updates	101
4.4 Power connection	48	6.16 Learning resources.....	102
4.5 Card reader connection	51	Chapter 7 System checks	103
		7.1 GPS Check.....	104

7.2 GPS Status.....	104	Chapter 15 Fuel manager.....	181
7.3 Raymarine GPS / GNSS receiver compatibility	105	15.1 Fuel manager overview	182
7.4 Radar check	106	Chapter 16 AIS function.....	185
7.5 Sonar check	107	16.1 AIS overview.....	186
7.6 Thermal camera setup and checks	108	16.2 AIS prerequisites.....	187
Chapter 8 Managing display data	111	16.3 AIS context menu.....	187
8.1 Memory cards and chart cards	112	16.4 Enabling AIS.....	188
8.2 Inserting a memory card or chart card	112	16.5 Displaying AIS vectors.....	188
8.3 Removing a memory card or chart card	113	16.6 AIS status symbols.....	189
8.4 Saving user data and user settings.....	113	16.7 AIS silent mode.....	189
8.5 Save and restore items.....	116	16.8 AIS target symbols	190
8.6 Screenshots	118	16.9 Displaying detailed AIS target information.....	191
8.7 Resetting your system	118	16.10 Viewing all AIS targets	191
Chapter 9 Customizing your display	119	16.11 Using AIS to avoid collisions.....	192
9.1 Language selection	120	16.12 Target options	193
9.2 Boat details.....	121	16.13 AIS alarms	194
9.3 Units set-up	122	16.14 Buddy tracking	194
9.4 Time and Date set-up	123	Chapter 17 Waypoints, Routes and Tracks	197
9.5 Display preferences	124	17.1 Waypoints overview.....	198
9.6 Databar and databox overview.....	127	17.2 Routes.....	207
9.7 List of data items.....	129	17.3 Tracks	215
9.8 System set-up menus.....	136	17.4 Import and Export.....	217
Chapter 10 Document viewer application	147	17.5 Waypoints, routes and tracks storage capacity	217
10.1 Document viewer overview	148	Chapter 18 Chart application.....	219
Chapter 11 Autopilot control	151	18.1 Chart application overview and features.....	220
11.1 Autopilot Control overview and features	152	18.2 Electronic charts overview	222
11.2 Enabling autopilot control	152	18.3 Navigation options.....	225
11.3 Engaging the autopilot	153	18.4 Chart ranging and panning.....	227
11.4 Adjusting the current locked heading	153	18.5 Chart selection.....	228
11.5 Disengaging the autopilot.....	154	18.6 Vessel position on the chart display	228
11.6 Manually displaying the pilot control dialog box	155	18.7 Chart Orientation.....	229
11.7 Pilot Control dialog	155	18.8 Chart motion mode.....	230
11.8 Pilot Bar	156	18.9 Chart views.....	231
11.9 Pilot Set-up	157	18.10 Chart display.....	233
11.10 Pilot settings.....	157	18.11 Overlays	233
11.11 Commissioning	160	18.12 Chart vectors	240
11.12 Autopilot status symbols.....	164	18.13 Cartography objects	241
11.13 Autopilot alarms.....	164	18.14 Object information	243
Chapter 12 Alarm management.....	165	18.15 Depth & Contour options.....	247
12.1 Alarms overview.....	166	18.16 My Data options	249
12.2 Alarm Manager overview	166	18.17 Multiple chart synchronization	249
12.3 Alarm options.....	169	18.18 Measuring distances and bearings	250
Chapter 13 Man Overboard (MOB).....	175	Chapter 19 Fishfinder application.....	251
13.1 Man overboard.....	176	19.1 Fishfinder overview and features	252
Chapter 14 DSC VHF radio integration.....	179	19.2 Sonar technologies.....	254
14.1 DSC VHF radio integration.....	180	19.3 Raymarine sonar modules	257
14.2 Enabling DSC VHF radio integration.....	180	19.4 Multiple sonar module support	257
		19.5 Sonar crosstalk interference.....	259
		19.6 Custom channels	261

19.7 The sonar image	262	22.2 Changing the camera feed	333
19.8 Depth Range	263	22.3 Displaying multiple camera feeds using Quad View	333
19.9 SideVision™ Range	264	22.4 Camera cycling	334
19.10 Fishfinder scrolling	264	22.5 Naming camera / video feeds	335
19.11 Fishfinder display modes	265	22.6 Adjusting the video image	336
19.12 SideVision™ Views	267	22.7 Selecting the aspect ratio	336
19.13 Presentation menu options	268	22.8 Selecting a location to store recordings	337
19.14 Depth and distance	269	22.9 Record and playback	337
19.15 Waypoints in the Fishfinder application	270	22.10 Taking photos	339
19.16 Sensitivity settings	270	22.11 Viewing photos	340
19.17 Fishfinder alarms	275		
19.18 Frequency tuning	276	Chapter 23 Thermal camera application — Pan and tilt cameras	341
19.19 Sounder set-up menu options	277	23.1 Thermal camera application overview	342
19.20 Transducer set-up menu options	278	23.2 Thermal camera image	342
19.21 Resetting the sonar	279	23.3 Controls overview	343
Chapter 20 Data application	281	23.4 Camera control	344
20.1 Data application overview	282	23.5 Image adjustments	346
20.2  Selecting datapages using touch	284	23.6 Pan and tilt camera — new camera interface	349
20.3  Selecting datapages	285	23.7 High power and high torque modes	352
20.4 Customizing the data application	285	23.8 Pan and tilt camera — old camera interface	353
20.5 List of data items	287		
20.6 Engine identification	294	Chapter 24 Thermal camera application — fixed mount cameras	357
20.7 Setting boat details	296	24.1 Thermal camera application overview	358
20.8 Setting maximum engine RPM	296	24.2 Thermal camera image	358
20.9 Color theme	297	24.3 Controls overview	359
20.10 Units set-up	298	24.4 Camera control	360
20.11 Resetting minimum and maximum readings	299	24.5 Image adjustments	360
20.12 Resetting all datapages	299	24.6 Fixed mount camera menu	362
Chapter 21 Radar application	301	Chapter 25 Fusion link application	365
21.1 Radar application overview and features	302	25.1 Fusion link overview	366
21.2 Multiple radar scanners	304	25.2 Media sources	367
21.3 Radar scanner status symbols	304	25.3 Browsing music	369
21.4 Radar context menu	306	25.4 Selecting shuffle and repeat functions	369
21.5 Radar range and image quality	306	25.5 Adjusting volume levels for each zone	370
21.6 Target tracking	309	25.6 Selecting the zone to control	370
21.7 Distances, range, and bearing	312	25.7 Adjusting the tone controls	371
21.8 Radar mode and orientation	315	25.8 Selecting the system to control	371
21.9 Radar presentation menu options	317	25.9 Menu options	372
21.10  Radar tuning: On-screen gain controls	320	Chapter 26 Weather application (North America only)	373
21.11 HD and SuperHD radar adjustments	321	26.1 Weather application overview	374
21.12 Non-HD digital radomes adjustments	323	26.2 Weather application set up	374
21.13 Dual range radar operation	325	26.3 Weather application display overview	375
21.14 Radar scan speed	326	26.4 Weather map navigation	378
21.15 Radar Set-up menu	327	26.5 Weather context menu	378
21.16 Resetting the radar	329	26.6 Weather information	379
Chapter 22 Camera application	331	26.7 Weather reports	380
22.1 Camera application overview and features	332	26.8 Animated weather graphics	381
		26.9 Weather application menu options	381

26.10 Glossary of weather terms	383	Appendix D Switch panel application.....	432
Chapter 27 Sirius audio application (North America only).....	385	Appendix E Software releases	434
27.1 Sirius audio overview.....	386	Appendix F Multifunction display compatibility	436
Chapter 28 Mobile applications.....	387		
28.1 Raymarine mobile apps	388		
28.2 Enabling Wi-Fi	389		
28.3 Enabling mobile apps	389		
28.4 Setting up Wi-Fi security	390		
28.5 Selecting a Wi-Fi channel	390		
Chapter 29 Maintaining your display.....	391		
29.1 Service and maintenance	392		
29.2 Product cleaning	392		
Chapter 30 Troubleshooting.....	393		
30.1 Troubleshooting	394		
30.2 Power up troubleshooting	395		
30.3 Radar troubleshooting	396		
30.4 GPS troubleshooting	397		
30.5 Troubleshooting Autorouting	398		
30.6 Sonar troubleshooting	400		
30.7 Sonar crosstalk interference.....	401		
30.8 Thermal camera troubleshooting	403		
30.9 System data troubleshooting.....	405		
30.10 Video troubleshooting	406		
30.11 Wi-Fi troubleshooting	407		
30.12 Bluetooth troubleshooting	408		
30.13 Touchscreen troubleshooting.....	409		
30.14 Miscellaneous troubleshooting	410		
Chapter 31 Technical specification.....	411		
31.1 Technical specification	412		
Chapter 32 Technical support	415		
32.1 Raymarine customer support	416		
32.2 Learning resources.....	416		
32.3 Third-party support.....	417		
Chapter 33 Spares and accessories	419		
33.1 gS Series accessories	420		
33.2 gS Series spares.....	420		
33.3 Network hardware	421		
33.4 Network cable connector types.....	421		
33.5 RayNet to RayNet cables and connectors.....	422		
33.6 Network cable types	424		
33.7 SeaTalk ^{ng} cabling components	424		
33.8 SeaTalk ^{ng} cables and accessories	425		
33.9 SeaTalk accessories.....	426		
Appendix A Connectors and pinouts	427		
Appendix B NMEA 0183 sentences	428		
Appendix C NMEA 2000 sentences	429		

Chapter 1: Important information

Certified Installation

Raymarine recommends certified installation by a Raymarine approved installer. A certified installation qualifies for enhanced product warranty benefits. Contact your Raymarine dealer for further details, and refer to the separate warranty document packed with your product.



Warning: Ensure safe navigation

This product is intended only as an aid to navigation and must never be used in preference to sound navigational judgment. Only official government charts and notices to mariners contain all the current information needed for safe navigation, and the captain is responsible for their prudent use. It is the user's responsibility to use official government charts, notices to mariners, caution and proper navigational skill when operating this or any other Raymarine product.



Warning: Product installation and operation

This product must be installed and operated in accordance with the instructions provided. Failure to do so could result in personal injury, damage to your vessel and/or poor product performance.



Warning: Minimum Safe Depth

The **Minimum Safe Depth** setting is used during **Autorouting** to restrict the created route from entering water that is too shallow for the vessel.

Bottom depth is taken from compatible electronic navigational charts and **Minimum Safe Depth** is a user calculation. As both of these factors are outside of Raymarine's control, Raymarine will not be held liable for any damage, physical or otherwise, resulting from the use of the **Autorouting** feature or the **Minimum Safe Depth** setting.



Warning: Autorouting

Routes created using the **Autorouting** feature rely on Bottom Depth information taken from compatible electronic cartography and a user defined **Minimum Safe Depth** value. As both of these values are subjective the generated route **MUST** be carefully checked and if necessary edited **BEFORE** starting to follow the route in the Chart application.



Warning: Autorouting — Traffic separation

The **Autorouting** feature does not adhere to the Traffic Separation Schemes identified in Rule 10 of the *International Regulations for Preventing Collisions at Sea 1972* as amended.

Raymarine® therefore recommends that you do **NOT** use **Autorouting** to create any part of a route which will cross traffic lanes or pass near to traffic separation lines. In these situations **Autorouting** **MUST** be switched Off and the route or route leg **MUST** be built manually, ensuring compliance to the rules laid out in the above regulations.



Warning: Potential ignition source

This product is **NOT** approved for use in hazardous/flammable atmospheres. Do **NOT** install in a hazardous/flammable atmosphere (such as in an engine room or near fuel tanks).



Warning: High voltages

This product may contain high voltages. Do **NOT** remove any covers or otherwise attempt to access internal components, unless specifically instructed in the documentation provided.



Warning: Product grounding

Before applying power to this product, ensure it has been correctly grounded, in accordance with the instructions provided.



Warning: Switch off power supply

Ensure the vessel's power supply is switched OFF before starting to install this product. Do **NOT** connect or disconnect equipment with the power switched on, unless instructed in this document.



Warning: FCC Warning (Part 15.21)

Changes or modifications to this equipment not expressly approved in writing by Raymarine Incorporated could violate compliance with FCC rules and void the user's authority to operate the equipment.



Warning: Radar scanner safety

Before rotating the radar scanner, ensure all personnel are clear.

**Warning: Radar transmission safety**

The radar scanner transmits electromagnetic energy. Ensure all personnel are clear of the scanner when the radar is transmitting.

**Warning: Sonar operation**

- NEVER operate the sonar with the vessel out of the water.
- NEVER touch the transducer face when the sonar is powered on.
- SWITCH OFF the sonar if divers are likely to be within 7.6 m (25 ft) of the transducer.

**Warning: Touchscreen display temperature**

If the display is mounted where it will be exposed to prolonged periods of direct sunlight, the touchscreen may get very hot due to the absorbed solar energy.

In such conditions Raymarine highly recommends that you avoid using the touchscreen:

- For HybridTouch displays, use the integrated keypad to operate the display.
- For touch-only systems it is recommended that an external keypad is fitted to the system (for example, the RMK-9 accessory).

**Warning: Touchscreen display**

Exposure to prolonged rain may cause erroneous touch performance, in these situations keep touch activity to a minimum and wipe the screen with a dry non-abrasive cloth before using the touchscreen.

Caution: Mounting surface requirements

This product is heavy. To prevent potential damage to the product and / or your vessel, observe the following BEFORE installing the product:

- Refer to the weight information provided in the technical specification for this product and ensure that the intended mounting surface is suitable for bearing the weight.
- If the mounting surface is not suitable for the product weight, you may need to reinforce the mounting surface.
- If in doubt, refer to a professional marine equipment installer for further guidance.

Caution: Power supply protection

When installing this product ensure the power source is adequately protected by means of a suitably-rated fuse or automatic circuit breaker.

Caution: Care of chart and memory cards

To avoid irreparable damage to and / or loss of data from chart and memory cards:

- DO NOT save data or files to a card containing cartography as the charts may be overwritten.
- Ensure that chart and memory cards are fitted the correct way around. DO NOT try to force a card into position.
- DO NOT use a metallic instrument such as a screwdriver or pliers to insert or remove a chart or memory card.

Caution: Ensure card reader door is securely closed

To prevent water ingress and consequent damage to the product, ensure that the card reader door is firmly closed.

Caution: Sun covers

- If your product is supplied with a sun cover, to protect against the damaging effects of ultraviolet (UV) light, always fit the sun cover when the product is not in use.
- Sun covers must be removed when travelling at high speed, whether in water or when the vessel is being towed.

Product operation in high temperatures

At extreme temperatures, the unit can become very hot, especially the internal components.

To protect the internal components, the unit automatically reduces the performance of the main processor to prevent it from overheating. When this occurs, you may notice a slight degradation in the performance of the unit, in terms of responsiveness to user operation.

This is expected behavior, designed to protect the unit from the adverse effects of excessive heat.

Caution: Product cleaning

When cleaning products:

- If your product includes a display screen, do NOT wipe the screen with a dry cloth, as this could scratch the screen coating.
- Do NOT use abrasive, or acid or ammonia based products.
- Do NOT use a jet wash.

Note: A class 0 device shall be assigned the same power allocation as a class 3 device.

Note: If a PoE device is connected that will take the total assigned power over 20 W the device will not be powered.

Power over Ethernet (PoE)

This product can supply Power over Ethernet (PoE) to class 1, 2 and 3 devices. The product can output a maximum of 20 Watts for consumption by PoE devices.

The PoE class denotes the power range of the PoE device.

PoE Class	Power range	Class description
Class 1	0.44 W to 3.84 W	Very low power
Class 2	3.84 W to 6.49 W	Low power
Class 3	6.49 W to 12.95 W	Mid power
Class 0	0.44 W to 12.95 W	-

Note: The product will not provide power to class 4 devices.

The product can power up to 3 devices using the available network / PoE ports as long as the combined max power of the PoE devices does not exceed 20 watts.

When a PoE device is connected it is interrogated to establish if the device is PoE and if so what class of device it is. The max power for that class of device is then assigned to that port (e.g. class 2 = 6.49 W) and deducted from the remaining power output.

The table below shows acceptable configurations of PoE devices.

Class 1 (3.84 W)	Class 2 (6.49 W)	Class 3 / Class 0 (12.95 W)	Total power used
1			3.84 W
2			7.68 W
3			11.52 W
	1		6.49 W
	2		12.98 W
	3		19.47 W
1	1		10.33 W
2	1		14.17 W
1	2		16.82 W
		1	12.95 W
1		1	16.79 W
	1	1	19.44 W

TFT Displays

The colors of the display may seem to vary when viewed against a colored background or in colored light. This is a perfectly normal effect that can be seen with all color Thin Film Transistor (TFT) displays.

Water ingress

Water ingress disclaimer

Although the waterproof rating capacity of this product meets the stated IPX standard (refer to the product's *Technical Specification*), water intrusion and subsequent equipment failure may occur if the product is subjected to commercial high-pressure washing. Raymarine will not warrant products subjected to high-pressure washing.

Disclaimers

This product (including the electronic charts) is intended to be used only as an aid to navigation. It is designed to facilitate use of official government charts, not replace them. Only official government charts and notices to mariners contain all the current information needed for safe navigation, and the captain is responsible for their prudent use. It is the user's responsibility to use official government charts, notices to mariners, caution and proper navigational skill when operating this or any other Raymarine product. This product supports electronic charts provided by third party data suppliers which may be embedded or stored on memory card. Use of such charts is subject to the supplier's End-User Licence Agreement included in the documentation for this product or supplied with the memory card (as applicable).

Raymarine does not warrant that this product is error-free or that it is compatible with products manufactured by any person or entity other than Raymarine.

This product uses digital chart data, and electronic information from the Global Positioning System (GPS) which may contain errors. Raymarine does not warrant the accuracy of such information and you are advised that errors in such information may cause the product to malfunction. Raymarine is not responsible for damages or injuries caused by your use or inability to use the product, by the interaction of the product with products manufactured by others, or by errors in chart data or information utilized by the product and supplied by third parties.

Memory cards and chart cards

MicroSD memory cards can be used to back up / archive data (e.g. Waypoint, and Tracks). Once data is backed up to a memory card old data can be deleted from the system, creating capacity for new data. The archived data can be retrieved at any time. Chart cards provide additional or upgraded cartography.

It is recommended that your data is backed up to a memory card on a regular basis. Do NOT save data to a memory card containing cartography.

Compatible cards

The following types of MicroSD cards are compatible with your display:

- Micro Secure Digital Standard-Capacity (MicroSDSC)
- Micro Secure Digital High-Capacity (MicroSDHC)

Note:

- The maximum supported memory card capacity is 32 GB.
- MicroSD cards must be formatted to use either the FAT or FAT 32 file system format to enable use with your MFD.

Speed class rating

For best performance it is recommended that you use Class 10 or UHS (Ultra High Speed) class memory cards.

Chart cards

Your product is pre-loaded with electronic charts (worldwide base map). If you wish to use different chart data, you can insert compatible chart cards into the unit's memory card reader.

Use branded chart cards and memory cards

When archiving data or creating an electronic chart card, Raymarine recommends the use of quality branded memory cards. Some brands of memory card may not work in your unit. Please contact customer support for a list of recommended cards.

EMC installation guidelines

Raymarine equipment and accessories conform to the appropriate Electromagnetic Compatibility (EMC) regulations, to minimize electromagnetic interference between equipment and minimize the effect such interference could have on the performance of your system

Correct installation is required to ensure that EMC performance is not compromised.

Note: In areas of extreme EMC interference, some slight interference may be noticed on the product. Where this occurs the product and the source of the interference should be separated by a greater distance.

For **optimum** EMC performance we recommend that wherever possible:

- Raymarine equipment and cables connected to it are:
 - At least 1 m (3 ft) from any equipment transmitting or cables carrying radio signals e.g. VHF radios, cables and antennas. In the case of SSB radios, the distance should be increased to 7 ft (2 m).
 - More than 2 m (7 ft) from the path of a radar beam. A radar beam can normally be assumed to spread 20 degrees above and below the radiating element.
- The product is supplied from a separate battery from that used for engine start. This is important to prevent erratic behavior and data loss which can occur if the engine start does not have a separate battery.
- Raymarine specified cables are used.
- Cables are not cut or extended, unless doing so is detailed in the installation manual.

Note: Where constraints on the installation prevent any of the above recommendations, always ensure the maximum possible separation between different items of electrical equipment, to provide the best conditions for EMC performance throughout the installation

RF exposure

This equipment complies with FCC / IC RF exposure limits for general population / uncontrolled exposure. The wireless LAN / Bluetooth antenna is mounted behind the front fascia of the display. This equipment should be installed and operated with a minimum distance of 1 cm (0.39 in) between the device and the body. This transmitter must not be co-located or operating in conjunction with any other antenna or transmitter, except in accordance with FCC multi-transmitter product procedures.

FCC

Compliance Statement (Part 15.19)

This device complies with Part 15 of the FCC Rules. Operation is subject to the following two conditions:

1. This device may not cause harmful interference.
2. This device must accept any interference received, including interference that may cause undesired operation.

FCC Interference Statement (Part 15.105 (b))

This equipment has been tested and found to comply with the limits for a Class B digital device, pursuant to Part 15 of the FCC Rules.

These limits are designed to provide reasonable protection against harmful interference in a residential installation. This equipment generates,

uses, and can radiate radio frequency energy and, if not installed and used in accordance with the instructions, may cause harmful interference to radio communications. However, there is no guarantee that interference will not occur in a particular installation. If this equipment does cause harmful interference to radio or television reception, which can be determined by turning the equipment off and on, the user is encouraged to try to correct the interference by one of the following measures:

1. Reorient or relocate the receiving antenna.
2. Increase the separation between the equipment and receiver.
3. Connect the equipment into an outlet on a circuit different from that to which the receiver is connected.
4. Consult the dealer or an experienced radio / TV technician for help.

Industry Canada

This device complies with Industry Canada License-exempt RSS standard(s).

Operation is subject to the following two conditions:

1. This device may not cause interference; and
2. This device must accept any interference, including interference that may cause undesired operation of the device.

This Class B digital apparatus complies with Canadian ICES-003.

Industry Canada (Français)

Cet appareil est conforme aux normes d'exemption de licence RSS d'Industry Canada.

Son fonctionnement est soumis aux deux conditions suivantes:

1. cet appareil ne doit pas causer d'interférence, et
2. cet appareil doit accepter toute interférence, notamment les interférences qui peuvent affecter son fonctionnement.

Cet appareil numérique de la classe B est conforme à la norme NMB-003 du Canada.

Japanese approvals

In the frequency band used for this device, campus radio stations (radio stations that require a license) and specified low power radio stations (radio stations that do not require license) for mobile identification and amateur radio stations (radio stations that require license) used in industries such as microwave ovens, scientific, medical equipment devices and production line of other factories are also being operated.

1. Before using this device, please make sure that campus radio stations and specified low power radio stations for mobile identification and amateur radio stations are not being operated nearby.
2. In case there is any case of harmful interference to campus radio stations for mobile identification caused by this device, please immediately change the frequency used or stop the transmission of radio waves and then consult about the measures to avoid interference (for example, the installation of partitions) through the contact information below.
3. Besides, when in trouble, such as when there is any case of harmful interference to specified low power radio stations for mobile identification or amateur radio stations caused by this device, please consult through the following contact information.

Contact information: Please contact your local authorized Raymarine dealer.

Third party software license agreements

This product is subject to certain third party software license agreements as listed below:

- GNU — LGPL/GPL
- JPEG libraries
- OpenSSL
- FreeType

The license agreements for the above can be found on the website www.raymarine.com and on the accompanying documentation CD if supplied.

Suppression ferrites

Raymarine cables may be fitted with suppression ferrites. These are important for correct EMC performance. If a ferrite has to be removed for any purpose (e.g. installation or maintenance), it must be replaced in the original position before the product is used.

Use only ferrites of the correct type, supplied by Raymarine authorized dealers.

Where an installation requires multiple ferrites to be added to a cable, additional cable clips should be used to prevent stress on the connectors due to the extra weight of the cable.

Connections to other equipment

Requirement for ferrites on non-Raymarine cables

If your Raymarine equipment is to be connected to other equipment using a cable not supplied by Raymarine, a suppression ferrite **MUST** always be attached to the cable near the Raymarine unit.

Declaration of conformity

Raymarine UK Ltd. declares that this product is compliant with the essential requirements of R&TTE directive 1999/5/EC.

The original Declaration of Conformity certificate may be viewed on the relevant product page at www.raymarine.com.

Product disposal

Dispose of this product in accordance with the WEEE Directive.



The Waste Electrical and Electronic Equipment (WEEE) Directive requires the recycling of waste electrical and electronic equipment. Whilst the WEEE Directive does not apply to some Raymarine products, we support its policy and ask you to be aware of how to dispose of this product.

Pixel defect policy

In common with all TFT units, the screen may exhibit a few wrongly-illuminated (“dead”) pixels. These may appear as black pixels in a light area of the screen or as colored pixels in black areas.

If your display exhibits **MORE** than the number of wrongly-illuminated pixels allowed (refer to the product *technical specification* for details), please contact your local Raymarine service center for further advice.

Warranty registration

To register your Raymarine product ownership, please visit www.raymarine.com and register online.

It is important that you register your product to receive full warranty benefits. Your unit package includes a bar code label indicating the serial number of the unit. You will need this serial number when registering your product online. You should retain the label for future reference.

IMO and SOLAS

The equipment described within this document is intended for use on leisure marine boats and workboats NOT covered by International Maritime Organization (IMO) and Safety of Life at Sea (SOLAS) Carriage Regulations.

Technical accuracy

To the best of our knowledge, the information in this document was correct at the time it was produced. However, Raymarine cannot accept liability for any inaccuracies or omissions it may contain. In addition, our policy of continuous product improvement may change specifications without notice. As a result, Raymarine cannot accept liability for any differences between the product and this document. Please check the Raymarine website (www.raymarine.com) to ensure you have the most up-to-date version(s) of the documentation for your product.

Chapter 2: Document and product information

Chapter contents

- [2.1 Handbook information on page 16](#)
- [2.2 Handbook conventions on page 17](#)
- [2.3 Product overview on page 19](#)
- [2.4 System feature highlights on page 20](#)

2.1 Handbook information

This handbook contains important information regarding your multifunction display.

The handbook is for use with gS Series multifunction displays.

About this handbook

This handbook describes how to operate your multifunction display in conjunction with compatible electronic cartography and peripheral equipment.

It assumes that all peripheral equipment to be operated with it is compatible and has been correctly installed. This handbook is intended for users of varying marine abilities, but assumes a general level of knowledge of display use, nautical terminology and practices.

Software revision

Raymarine regularly updates product software to add new features and improve existing functionality.

	This handbook covers multifunction display software version — LightHouse II Release 12. Please refer to the <i>Software Releases</i> section for details on software releases. Check the Raymarine® website to ensure you have the latest software and user manuals. www.raymarine.com .
---	---

Handbooks

The following handbooks are applicable to your multifunction display:

gS Series Handbooks

Description	Part number
Mounting and getting started guide	88017
Installation and operation handbook	81344
gS95 Mounting template	87173
gS125 Mounting template	87171
gS165 Mounting template	87172
gS195 Mounting template	87198
RCR-2 Mounting template	87186

Additional handbooks

Description	Part number
SeaTalk ^{ng} reference manual	81300
RMK-9 Installation and operations instructions	81351

All documents are available to download as PDFs from www.raymarine.com

User manuals Print Shop

Raymarine provides a Print Shop service, enabling you to purchase a high-quality, professionally-printed manual for your Raymarine product.

Printed manuals are ideal for keeping onboard your vessel, as a useful source of reference whenever you need assistance with your Raymarine product.

Visit <http://www.raymarine.co.uk/view/?id=5175> to order a printed manual, delivered directly to your door.





For further information about the Print Shop, please visit the Print Shop FAQ pages: <http://www.raymarine.co.uk/view/?id=5751>.

Note:

- Accepted methods of payment for printed manuals are credit cards and PayPal.
- Printed manuals can be shipped worldwide.
- Further manuals will be added to the Print Shop over the coming months for both new and legacy products.
- Raymarine user manuals are also available to download free-of-charge from the Raymarine website, in the popular PDF format. These PDF files can be viewed on a PC / laptop, tablet, smartphone, or on the latest generation of Raymarine multifunction displays.

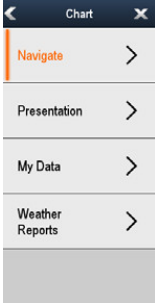
2.2 Handbook conventions



The following conventions are used throughout this handbook when referring to:

Type	Example	Convention
Icons		<p>The term "select" is used in procedures involving icons to refer to the action of selecting an on-screen icon, either using touch or physical buttons:</p> <ul style="list-style-type: none"> • Touch — Press your finger on the icon to select. • Physical buttons — Use the Joystick to highlight the icon and press the Ok button.
Menus		<p>The term "select" is used in procedures involving menus to refer to the action of selecting a menu item, either using touch or physical buttons:</p> <ul style="list-style-type: none"> • Touch — Press your finger on the icon to select. • Physical buttons — Use the Joystick to highlight the icon and press the Ok button.
		<p>The term "scroll" is used in procedures involving menus and dialogs to refer to the action of scrolling a list or menu, either by touch or physical buttons:</p> <ul style="list-style-type: none"> • Touch — Press your finger on the menu and slide up or down to scroll. • Physical buttons — Turn the Rotary control clockwise or anti-clockwise to scroll.
Applications		<p>The term "select" is used in procedures involving applications to refer to the action of selecting a location, object or target on-screen using touch or physical buttons:</p> <ul style="list-style-type: none"> • Touch — Press and hold your finger on a location to select, or • Touch — Press and release your finger on an object or target. • Physical buttons — Use the Joystick to highlight the location, object or target and press the Ok button.
Numeric adjust controls		<p>The term "adjust" is used in procedures involving numerical adjust controls to refer to the action of changing the numeric value using touch or physical buttons:</p> <ul style="list-style-type: none"> • Touch — Press your finger on the up or down arrow to increase or decrease the numeric value. • Physical buttons — Use the Rotary control to increase or decrease the numeric value.

Type	Example	Convention
		With the Numeric adjust control displayed you can also select on the keypad icon or press and hold the Ok button to open a numeric keypad to enter a new value for the setting.
Slider bar controls		<p>The term “adjust” is used in procedures involving slider bar controls to refer to the action of changing the associated numeric value using touch or physical buttons:</p> <ul style="list-style-type: none"> • Touch — Press your finger on the up or down arrow to increase or decrease the numeric value. • Physical buttons — Use the Rotary control to increase or decrease the numeric value.

Waypoint (MOB) button / icon

Depending on the multifunction display variant there will be either a Waypoint (MOB) button or an on-screen icon.



WPT button		<ul style="list-style-type: none"> • c Series • e Series • RMK-9 keypad
WPT icons		<ul style="list-style-type: none"> • a Series • gS Series

Throughout this manual the term: Select **WPT**, refers to pressing the physical **WPT** button or pressing the on-screen **WPT** icon.

Touch and non-touch operations

This handbook applies to both touch and non-touch operations.

This handbook uses icons to identify whether a particular task is specifically a touch or a non-touch operation. Where a task does not have a touch or non-touch icon then the task can be performed using either.

	Touch (Touchscreen operation) — Touch operations apply to multifunction displays which have a touchscreen.
	Non-touch (physical button operation) — Non-touch operations apply to multifunction displays with physical buttons or multifunction displays that have a remote keypad connected and paired to it.

2.3 Product overview

Product information

gS Series Multifunction Displays (MFDs) are touchscreen displays which have HybridTouch functionality when paired with a remote keypad. The following Raymarine MFD variants are available.

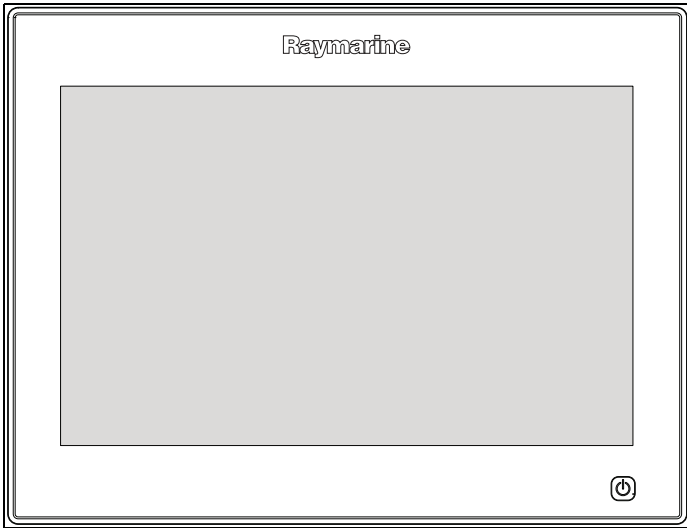

Model	Part number
gS95	E70124
gS95 inverted	E70183
gS125	E70125
gS125 inverted	E70184
gS165	E70126
gS165 inverted	E70185
gS195	E70213

Refer to the [Optimum viewability](#) section for details on standard vs inverted displays.

HybridTouch overview

If your multifunction display features HybridTouch, this enables you to operate the unit using the touchscreen and the physical buttons.

A HybridTouch display has physical buttons which can be used in addition to the touchscreen. Touchscreen only multifunction displays (which do not have physical buttons) can be connected to a remote keypad which allows HybridTouch functionality.

All functions can be accessed using the touchscreen. However, there may be situations (such as rough sea conditions) when it is not appropriate to use the touchscreen. In these situations, Raymarine strongly recommends that you activate the touch lock and use the physical buttons to operate your multifunction display.

Touchscreen overview

The touchscreen provides an alternative to using physical buttons to control your multifunction display.

All functions can be accessed using the touchscreen

Note: Raymarine strongly recommends that you familiarize yourself with touch operations while your vessel is anchored or moored. You may find it helpful to use the simulator mode (accessible from **Homescreen > Set-up > System Settings**) in these situations.



2.4 System feature highlights



Features that enable you to connect and control a complete marine electronics system.



Feature	Benefits	What it is	How to use it
<p>Control your entire marine electronics system from one display. Alternatively, create a network of several displays to control your system from multiple locations on your vessel. Easily connect all your devices together in a powerful, unified and expandable system using SeaTalk^{hs}, SeaTalk^{ng}, NMEA 0183, and NMEA 2000 connections.</p> <div data-bbox="97 528 517 703" style="border: 1px solid black; padding: 5px;"> <p>Note: For NMEA 0183 connections, a65, a67, a68, a75, a77, and a78 only support the connection of a VHF radio and require an additional NMEA 0183 to SeaTalk^{ng} converter.</p> </div>	<p>These data connections enable you to connect an extensive range of external equipment to your MFD, enabling you to make the most of your time on the water. Examples of popular devices include:</p> <ul style="list-style-type: none"> • Sonar module (“Fishfinder”). • Radar scanner. • Thermal camera. • Data sensors (wind, speed, depth etc). • IP video camera. • Autopilot system. • AIS receiver / transceiver. • Fusion media player. • Sirius audio & weather receiver. • Satellite TV. • DSC VHF radio. • Smartphones and tablets. • Digital switching modules. <div data-bbox="544 1059 975 1137" style="border: 1px solid black; padding: 5px;"> <p>Note: Refer to ‘<i>System Integration</i>’ for a list of suitable devices.</p> </div>	<ul style="list-style-type: none"> • 3.7 System protocols • System integration(a Series, c Series, e Series) • 3.1 System integration (gS Series) • Typical systems(a Series, c Series, e Series) • 3.6 Typical systems (gS Series) • 33.3 Network hardware • System Limits 	<p>Chapter 4 Cables and connections</p>
<p>Support for multiple data sensors.</p>	<p>Connect to a wide range of external data sensors (such as wind, speed, depth) to receive critical information about the environment around your vessel. Use the Data application and configurable databar to customize the data to suit your needs.</p>	<ul style="list-style-type: none"> • 9.7 List of data items • System integration(a Series, c Series, e Series) • 3.1 System integration (gS Series) • Typical systems(a Series, c Series, e Series) • 3.6 Typical systems (gS Series) 	<ul style="list-style-type: none"> • 20.1 Data application overview • 9.6 Databar and databox overview • 9.3 Units set-up
<p>Support for multiple sonar modules.</p>	<ul style="list-style-type: none"> • Support for multiple active sonar modules on the network; ability to use multiple sonar modules simultaneously and display the returns from both on the screen at the same time — for example, CP100 and CP300, in a splitscreen configuration. • Take advantage of Raymarine’s Visionality™ technology — View the world beneath your vessel with photo-like clarity. • Setup the Fishfinder application in a way that reflects how you fish; create 	<ul style="list-style-type: none"> • 19.1 Fishfinder overview and features • 19.2 Sonar technologies • 19.3 Raymarine sonar modules 	<p>19.4 Multiple sonar module support</p>

Feature	Benefits	What it is	How to use it
	<p>custom “application panes”, each one representing a different combination of “channels” (frequencies) to suit different user scenarios.</p> <div style="border: 1px solid black; padding: 5px;"> <p>Note: Not all MFDs include an internal sonar module. An external sonar module may be required for Fishfinder operation. Refer to your dealer.</p> </div>		
Support for 2 radar scanners.	<ul style="list-style-type: none"> Support up to 2 radar scanners on the same network. Set-up custom page to show more than 1 radar scanner onscreen at the same time. 	<ul style="list-style-type: none"> 21.1 Radar application overview and features 	<ul style="list-style-type: none"> 21.2 Multiple radar scanners
Wireless video streaming and wireless MFD control via tablet or smartphone.	<p>With the optional mobile apps and an Android or Apple iOS compatible mobile device you can:</p> <ul style="list-style-type: none"> Stream an MFD video feed to your mobile device. Anything that is displayed on your MFD screen can also be displayed on your mobile device. Control your MFD from anywhere on your vessel. Your mobile device acts as a repeat display and intuitive control surface for your MFD. Graphical representations of the MFD controls on your mobile display give you total remote control of your MFD. 	Chapter 28 Mobile applications	<ul style="list-style-type: none"> 28.2 Enabling Wi-Fi 28.3 Enabling mobile apps 28.4 Setting up Wi-Fi security
LightHouse user interface — universal networking and operation.	<ul style="list-style-type: none"> Take the Easy Route™ — Raymarine’s intuitive touch-based user experience makes it easy to find and use the features you need. Raymarine LightHouse MFDs give you the powerful ability to “mix and match” any combination of LightHouse MFD products in a single networked system. This includes all MFD variants in the a Series, c Series, e Series, and gS Series ranges. The LightHouse universal software platform ensures that all user operations are identical across all MFDs in the system. Once you’ve learned how to use one LightHouse MFD variant, you’ve learned how to use them all. <div style="border: 1px solid black; padding: 5px;"> <p>Note: Ensure that all your MFDs are running the same software version.</p> </div>	2.3 Product overview	<ul style="list-style-type: none"> Chapter 6 Getting started 6.10 Initial set up procedures

Feature	Benefits	What it is	How to use it
Control an autopilot system.	<ul style="list-style-type: none"> • With a suitable connected Evolution autopilot system, you can control an autopilot directly from your MFD, without a separate dedicated pilot control head. • Make the most of Raymarine's Automagic™ technology. Evolution autopilots use a range of advanced technologies to eliminate the need for complicated setup and calibration. With its intelligent sensor capabilities, the autopilot automatically adapts to your vessel's steering characteristics without any user adjustments. Only a basic set up procedure is required, using a simple Dockside Wizard. • Vessels with hydraulic steering systems benefit from Raymarine's Hydro-Balance™ technology, which automatically detects and compensates for common steering system problems. 	11.1 Autopilot Control overview and features	<ul style="list-style-type: none"> • 11.9 Pilot Set-up • 11.8 Pilot Bar
View and control multiple thermal video cameras.	<ul style="list-style-type: none"> • Your “Sixth Sense” at sea. View the world around your vessel — even in total darkness. Thermal technology sees temperature, not visible light. This means that it sees things that the human eye can't. • Enhance your situational awareness — a thermal camera can help you to navigate the seas at night or in poor visibility. • Enhance the safety of you and your crew — a thermal camera can quickly identify a person in the water in man-overboard situations. • Control the camera directly from your MFD or, optionally, via a Joystick Control Unit (JCU) — or both. 	24.1 Thermal camera application overview	23.4 Camera control
View multiple analog visible-light video cameras. <div style="border: 1px solid black; padding: 5px; width: fit-content;">Note: Not all MFD variants support the connection of analog video devices. Refer to the Chapter 31 Technical Specification section for more information.</div>	Video cameras have many monitoring uses: <ul style="list-style-type: none"> • Security. • Engine room. • Rear of boat. • Docking. • Any regular surveillance. • Mast-top camera. • The MFD can be set up to continuously and automatically cycle through the available video inputs. 	22.1 Camera application overview and features	<ul style="list-style-type: none"> •  Changing the camera / video feed • 22.4 Camera cycling

Feature	Benefits	What it is	How to use it
View and record IP cameras.	<p>IP video cameras provide powerful networking capabilities and have many monitoring uses:</p> <ul style="list-style-type: none"> • Security. • Engine room. • Rear of boat. • Docking. • Any regular surveillance. • Mast-top camera. • The MFD can be set up to continuously and automatically cycle through the available video inputs. • The MFD can be set up to display up to 4 camera feeds simultaneously. • You can record the video feed from an IP camera to a MicroSD memory card inserted in your MFD. 	22.1 Camera application overview and features	<ul style="list-style-type: none"> •  Changing the camera / video feed • 22.4 Camera cycling • 22.3 Displaying multiple camera feeds using Quad View • 22.9 Record and playback
<p>View a video source such as a DVD player.</p> <div data-bbox="129 898 547 1066" style="border: 1px solid black; padding: 5px;"> <p>Note: Not all MFD variants support the connection of analog video devices. Refer to the Chapter 31 Technical Specification section for more information.</p> </div> <div data-bbox="129 1088 547 1256" style="border: 1px solid black; padding: 5px;"> <p>Note: To hear the audio feed from a connected video device, a suitable external third-party audio system is required. MFDs do not have internal audio speakers.</p> </div>	<ul style="list-style-type: none"> • Watch movies. • Watch television broadcasts, such as the latest sporting event (requires an external Satellite TV receiver). • Play videogames. • Playback video footage or view photos from an external digital camera or video camera. • View the video output from a suitable smartphone, tablet, or laptop. • The display can be set up to continuously and automatically cycle through the available video inputs. <div data-bbox="576 1323 1007 1536" style="border: 1px solid black; padding: 5px;"> <p>Note: These activities require suitable additional third-party external equipment such as DVD players, TV / satellite receivers, cables, video converters, and / or software. Refer to your dealer for more information.</p> </div>	22.1 Camera application overview and features	<ul style="list-style-type: none"> •  Changing the camera / video feed •
Display engine data.	<p>With the Engine page in the Data application, you can view important data from connected engines:</p> <ul style="list-style-type: none"> • Oil pressure. • Coolant temperature. • Engine RPM. • Total fuel available (estimated). • and more... <div data-bbox="576 1906 1007 2141" style="border: 1px solid black; padding: 5px;"> <p>Note: Depending on the type of engine installed on your vessel, this feature may require an engine interface unit (such as the ECI-100) to connect the engine's CAN data bus to the network. Refer to your local dealer.</p> </div>	Engine page	<ul style="list-style-type: none"> • 6.12 Engine identification • Engine setup with an ECI interface • Using the engine identification wizard

Feature	Benefits	What it is	How to use it
Control your vessel's electrical systems	<p>The Digital Switching (“Switch Panel”) application and optional EmpirBus™ digital switching modules allow you to take control of your vessel's electrical systems:</p> <ul style="list-style-type: none"> • Control lighting. • Monitor ac and dc electrical systems. • Remotely monitor fluid tanks and battery levels. • and more... <div style="border: 1px solid black; padding: 5px; margin-top: 10px;"> <p>Note: EmpirBus™ is a trademark of Trigent AG.</p> </div>	Switch panel overview	Switch panel configuration
Fuel management.	<p>Allows you to more accurately plan and manage your time on the water:</p> <ul style="list-style-type: none"> • Display the estimated remaining fuel available for your vessel. Based on this figure, the estimated remaining distance and time is automatically calculated. • Display “remaining distance” information visually on the chart by setting up a “fuel range ring” overlay in the Chart application. • Set a “low fuel” alarm to alert you when your vessel's fuel level falls to a specified amount. <div style="border: 1px solid black; padding: 5px; margin-top: 10px;"> <p>Note: Fuel manager estimates are based on: you logging the amount each time you fill the vessel with fuel; the total fuel capacity of your vessel's tanks; and how much fuel is burned by the engine(s).</p> </div>	15.1 Fuel manager overview	<ul style="list-style-type: none"> • Enabling the fuel manager • Setting up fuel manager • Setting the low fuel alarm • Enabling the fuel range ring
Simulator Mode.	<p>Simulator Mode enables you to practice using your display and familiarize yourself with its operation, even when you are not out on the water.</p>	Simulator mode	Enabling and disabling simulator mode
Free regular software updates.	<p>Raymarine regularly updates its product software to bring you new features and fix existing issues. Check the Raymarine website on a regular basis to ensure that you're using the latest software.</p>	<ul style="list-style-type: none"> • 6.15 Software updates • http://www.raymarine.com/software/ 	Updating the software
Customizable homescreen and applications.	<ul style="list-style-type: none"> • The homescreen acts as a central hub for your entire marine electronics system, providing access to all your devices via a large range of applications. • You can access the homescreen quickly at any time using the on-screen Home icon or the physical Home button (if available). • The homescreen can be customized to include only the applications you need. • Split-screen views — Display multiple applications at the same time. Create 	<ul style="list-style-type: none"> • 6.3 Homescreen overview — Touch only displays • Homescreen overview — c Series / e Series • 6.5 Applications • 6.4 Pages • 6.6 Splitscreen controls 	<ul style="list-style-type: none"> •  Accessing the homescreen •  Accessing the homescreen • Changing an existing page on the homescreen • Menus • Dialogs

Feature	Benefits	What it is	How to use it
	<p>you own custom pages to suit your exact needs. Choose any combination of applications for each page — chart / sonar, chart / radar, chart / thermal camera and so on.</p> <ul style="list-style-type: none"> Each application can be customized to suit you with comprehensive “Setup” options. 		
Configurable databar.	<ul style="list-style-type: none"> The databar is displayed at all times, giving you a persistent view of important data (such as LAT / LON position and COG / SOG). You can customize the databar to display the data that’s important to you. When selected, the databar expands to provide a “databox”, which provides additional data. You can choose the data that will be displayed. Auto-hide: To free-up screen space, you can configure your MFD to auto-hide the databar after 10 seconds. Re-display the databar at any time by selecting the status bar. 	<ul style="list-style-type: none"> 9.6 Databar and databox overview 	<ul style="list-style-type: none"> Customizing the databar  Auto-hide the databar
System diagnostics.	<ul style="list-style-type: none"> Display a comprehensive list of information for the MFD and all connected devices, along with software versions and serial numbers. Record live data streams from the data busses (SeaTalk^{ng}, NMEA 0183 etc), for advanced diagnostics and for sending system information to Raymarine product support in the event of a technical issue. 	<ul style="list-style-type: none"> Maintenance menu Diagnostics menu 	Viewing product information
Shared brightness.	If you have multiple MFDs and instruments in your system you can configure the system to use the same display brightness setting across all networked displays. When you change the brightness on one display, all other displays are changed simultaneously and automatically.	Shared brightness	Setting up shared brightness
PDF document viewer.	<p>View the instruction manuals for all your Raymarine products directly on your MFD. Also view any PDF document stored on a memory card.</p> <div style="border: 1px solid black; padding: 5px;"> <p>Note: Password-protected PDFs or PDFs containing security certificates are not supported.</p> </div>	10.1 Document viewer overview	<ul style="list-style-type: none"> Opening a PDF document  Searching for text

More help

Access Raymarine’s learning resources on the Internet to obtain more information and help on some of the features described below: [6.16 Learning resources](#).

Chapter 3: Planning the installation

Chapter contents

- 3.1 System integration on page 28
- 3.2 Installation checklist on page 33
- 3.3 Multiple data sources (MDS) overview on page 33
- 3.4 Identifying your display variant on page 34
- 3.5 Networking constraints on page 34
- 3.6 Typical systems on page 36
- 3.7 System protocols on page 38
- 3.8 Data master on page 39
- 3.9 Parts supplied on page 39
- 3.10 Tools required for installation on page 40
- 3.11 Selecting a location on page 41

3.1 System integration

Your multifunction display is compatible with a wide range of marine electronics devices.

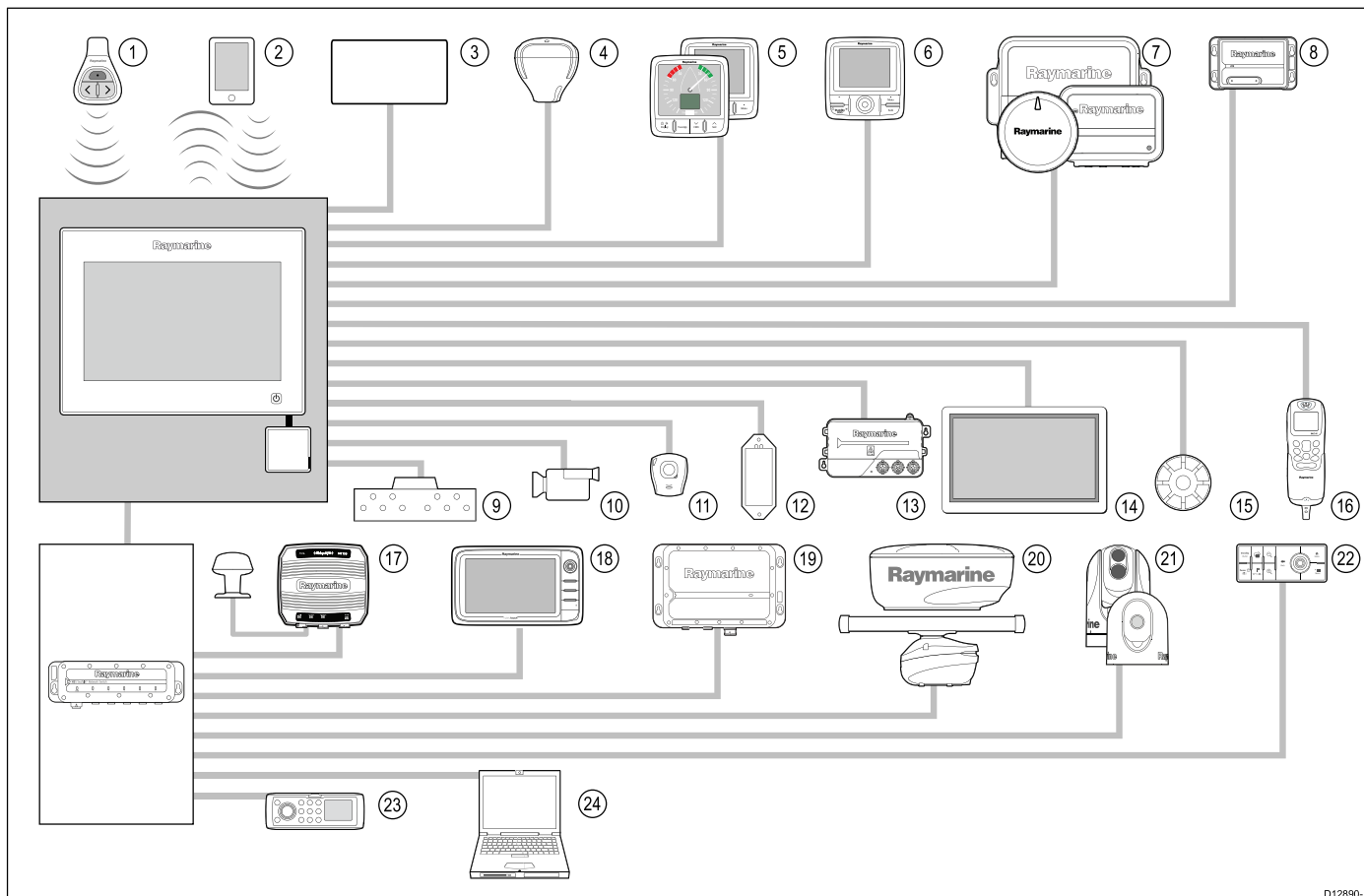

D12890-1

The display uses a number of protocols to transfer data between the various devices in your system. The following table details which devices may be connected to your display, and the type of connections (in terms of protocols and physical interfaces):

Item	Device Type	Maximum quantity	Suitable Devices	Connections
1	Remote control	1 per multifunction display.	Raymarine® RCU-3	Bluetooth
2	Smartphone / Tablet device	1 per multifunction display.	<p>For Raymarine wireless video streaming and remote control apps:</p> <ul style="list-style-type: none"> • Apple iPhone 4 (or later) or iPad 2 (or later) • Android device with minimum 1GHz processor and running android 2.2.2 (or later) • Amazon Kindle Fire <p>For chartplotter sync with Navionics Marine app:</p> <ul style="list-style-type: none"> • Apple iPhone or iPad • Android-compatible smartphone or tablet <p>For media player control:</p> <ul style="list-style-type: none"> • Any Bluetooth-enabled device that supports Bluetooth 2.1+ EDR power class 1.5 (supported profile: AVRCP 1.0) 	<ul style="list-style-type: none"> • Chartplotter sync with Navionics Marine app: Wi-Fi • Video streaming and remote control: Wi-Fi • Media player control: Bluetooth 2.1+ EDR power class 1.5 (supported profile: AVRCP 1.0) or later

Item	Device Type	Maximum quantity	Suitable Devices	Connections
3	Vessel tank sensors — third-party	<ul style="list-style-type: none"> • Up to 5 x fuel. • 1 x fresh water. • 1 x waste water. • 1 x sewage. • 1 x bait / fish. 	Third-party NMEA 2000 interfaces	NMEA 2000 (via optional DeviceNet adaptor cables)
4	GPS / GNSS Receiver (external) — Raymarine®	1	Any combination of the following: <ul style="list-style-type: none"> • RS130 • Raystar125 GPS • Raystar125+GPS (via optional SeaTalk to SeaTalk^{ng}® converter) 	SeaTalk , SeaTalk^{ng}® , or NMEA 0183
5	Instruments — Raymarine®	As determined by SeaTalk^{ng}® bus bandwidth and power loading.	SeaTalk^{ng}® : <ul style="list-style-type: none"> • i50 Depth, Speed, or Tridata • i60 Wind, CH Wind • i70 • ST70+ • ST70 SeaTalk (via optional SeaTalk to SeaTalk^{ng}® converter): <ul style="list-style-type: none"> • i40 Wind, Speed, Depth, or Bidata • ST60+ Wind, Speed, Depth, Rudder, or Compass • ST40 Wind, Speed, Depth, Rudder, or Compass 	SeaTalk , SeaTalk^{ng}®
6	Pilot control heads — Raymarine®	As determined by SeaTalk or SeaTalk^{ng}® bus bandwidth and power loading, as appropriate.	SeaTalk^{ng}® : <ul style="list-style-type: none"> • p70 • p70R • ST70 (SeaTalk^{ng}® course computer only.) • ST70+ (SeaTalk^{ng}® course computer only.) SeaTalk (via optional SeaTalk to SeaTalk^{ng}® converter): <ul style="list-style-type: none"> • ST6002 • ST7002 • ST8002 	SeaTalk , SeaTalk^{ng}®
7	Autopilots — Raymarine®	1	SeaTalk^{ng}® : <ul style="list-style-type: none"> • Evolution autopilots • All SPX course computers SeaTalk (via optional SeaTalk to SeaTalk^{ng}® converter): <ul style="list-style-type: none"> • ST1000 • ST2000 • S1000 • S1 	SeaTalk , SeaTalk^{ng}® , or NMEA 0183

Item	Device Type	Maximum quantity	Suitable Devices	Connections
			<ul style="list-style-type: none"> • S2 • S3 	
8	AIS — Raymarine®	1	<ul style="list-style-type: none"> • AIS350 • AIS650 • AIS950 • AIS250 • AIS500 	SeaTalk ^{ng} ®, or NMEA 0183
8	AIS — third-party	1	Third-party NMEA 0183-compatible AIS Class A or Class B receiver / transceiver	NMEA 0183
9	Vessel trim tabs — third-party	1 pair	Third-party NMEA 2000 interfaces	NMEA 2000 (via optional DeviceNet adaptor cables)
10	Analog video / camera	2	Composite PAL or NTSC video source	BNC connectors
10	IP camera	Multiple	<ul style="list-style-type: none"> • CAM200IP <div style="border: 1px solid black; padding: 5px; margin-top: 5px;"> <p>Note: Whilst third-party ONVIF compatible IP cameras may work, Raymarine® cannot guarantee their compatibility.</p> </div>	Via SeaTalk ^{hs} network
11	Lifetag (Man overboard alert)	1 basestation	All Raymarine® Lifetag basestations	SeaTalk (via optional SeaTalk to SeaTalk ^{ng} ® converter)
12	Engine interface — Raymarine®	1 unit for each engine CAN bus	<ul style="list-style-type: none"> • ECI-100 	SeaTalk ^{ng} ®
12	Engine interface — third-party	1	Third-party NMEA 2000 interfaces	NMEA 2000 (via optional DeviceNet adaptor cables)
13	Transducers and sensors — Raymarine	Multiple	Analog transducers: <ul style="list-style-type: none"> • Wind • Speed • Depth • Rudder reference • Fluxgate compass 	SeaTalk ^{ng} (via optional iTC-5 converter)
13	Transducers and sensors — Airmar	1	<ul style="list-style-type: none"> • DT800 Smart Sensor • DST800 Smart Sensor • PB200 weather station 	SeaTalk ^{ng} ® (via optional iTC-5 converter)
14	External display	1	HDTV	HDMI
15	Auxiliary alarm	1	as supplied	Connected using the Video in / Alarm connector.
16	DSC VHF radio — Raymarine®	1	SeaTalk ^{ng} ®: <ul style="list-style-type: none"> • Ray260 • Ray260 AIS NMEA 0183: <ul style="list-style-type: none"> • Ray49 • Ray55 • Ray218 • Ray240 	SeaTalk ^{ng} ®, or NMEA 0183

Item	Device Type	Maximum quantity	Suitable Devices	Connections
17	Raymarine® Sirius marine weather / satellite radio receiver (North America only)	1	SeaTalk^{hs}: <ul style="list-style-type: none"> • SR150 • SR100 • SR6 SeaTalk^{ng}: <ul style="list-style-type: none"> • SR50 	SeaTalk ^{hs} , SeaTalk ^{ng} ®
18	Additional multifunction display(s) — Raymarine®	9	3rd generation Raymarine® multifunction displays SeaTalk^{hs} (recommended): <ul style="list-style-type: none"> • a Series • c Series • e Series • gS Series <div style="border: 1px solid black; padding: 5px; margin-top: 10px;"> <p>Note: You can connect Raymarine® multifunction displays using NMEA 0183 or SeaTalk^{ng}® but not all functions are supported.</p> </div> <div style="border: 1px solid black; padding: 5px; margin-top: 10px;"> <p>Note: Visit www.raymarine.com to download the latest software version for your display.</p> </div>	SeaTalk ^{hs}
18	Additional multifunction display(s) — third-party	<ul style="list-style-type: none"> • Connections to multifunction display NMEA outputs: 4 • Connections to multifunction display NMEA inputs: 2 	NMEA 0183-compatible chartplotters and multifunction displays	NMEA 0183
19	Sonar Modules (Fishfinder) — Raymarine®	1	<ul style="list-style-type: none"> • CP100 — DownVision™ • CP200 — SideVision™ • CP300 — Traditional sonar • CP450C — CHIRP sonar • Sonar and DownVision™ variant MFDs 	SeaTalk ^{hs}
20	Radar — Raymarine®	2	All Raymarine® Non-HD Digital Radomes and HD or SuperHD radar scanners. <div style="border: 1px solid black; padding: 5px; margin-top: 10px;"> <p>Note: Please ensure your radar scanner is using the latest software version.</p> </div>	SeaTalk ^{hs}
21	Thermal camera — Raymarine®	1	<ul style="list-style-type: none"> • T200 Series • T300 Series • T400 Series • T800 Series • T900 Series 	SeaTalk ^{hs} (for control), BNC connector (for video)
22	Remote keypad	Multiple	<ul style="list-style-type: none"> • RMK-9 	SeaTalk ^{hs}

Item	Device Type	Maximum quantity	Suitable Devices	Connections
23	Fusion entertainment systems	Multiple	Fusion 700 series entertainment systems: <ul style="list-style-type: none"> • MS-IP700 • MS-AV700 	SeaTalk^{hs}
24	PC / laptop	1	Windows-compatible PC or laptop running Raymarine Voyager planning software.	SeaTalk^{hs}

Note: Raymarine® cannot guarantee the compatibility of any third-party devices listed above.

3.2 Installation checklist

Installation includes the following activities:

Installation Task	
1	Plan your system.
2	Obtain all required equipment and tools.
3	Site all equipment.
4	Route all cables.
5	Drill cable and mounting holes.
6	Make all connections into equipment.
7	Secure all equipment in place.
8	Power on and test the system.

3.3 Multiple data sources (MDS) overview

Installations that include multiple instances of data sources can cause data conflicts. An example is an installation featuring more than one source of GPS data.

MDS enables you to manage conflicts involving the following types of data:

- GPS Position.
- Heading.
- Depth.
- Speed.
- Wind.

Typically this exercise is completed as part of the initial installation, or when new equipment is added.

If this exercise is NOT completed the system will automatically attempt to resolve data conflicts. However, this may result in the system choosing a source of data that you do not want to use.

If MDS is available the system can list the available data sources and allow you to select your preferred data source. For MDS to be available all products in the system that use the data sources listed above must be MDS-compliant. The system can list any products that are NOT compliant. It may be necessary to upgrade the software for these non-compliant products to make them compliant. Visit the Raymarine website (www.raymarine.com) to obtain the latest software for your products. If MDS-compliant software is not available and you do NOT want the system to automatically attempt to resolve data conflicts, any non-compliant product(s) can be removed or replaced to ensure the entire system is MDS-compliant.

3.4 Identifying your display variant

To discover which model display you have follow the steps below:



Device	Serial No	Network	Software
gS95	E70124 0130015	This Device	v7.14-003
e95	E70022 1010041	SeaTalkHS	v7.14-003
c95	E70012 1110007	SeaTalkHS	v7.14-003
e7	E62355 0320248	SeaTalkHS	v7.14-003
a67	E70077 0820023	SeaTalkHS	v7.14-003
RMK-9	A80217 0130006	SeaTalkHS	v7.14-003
E22158-SeaTalk-STNG-Converter	0611380	STng	1.11

From the homescreen:

1. Select **Set-up**.
2. Select **Maintenance**.
3. Select **Diagnostics**.
4. Select **Select Device**.
5. Search the Network column for the '**This Device**' entry.
6. The Device column for this record will list the model of your display.

3.5 Networking constraints

Raymarine's 3rd generation **LightHouse** powered **MFDs** (**a Series**, **c Series**, **e Series** and **gS Series**) can be networked together.

General

- Up to 10 **LightHouse** powered **MFDs** can be connected together using **SeaTalk^{hs}**.
- **MFDs** can also be connected via **SeaTalk^{ng}**® or **NMEA 0183**, but not all functions are supported.
- All networked **aa Series**, **c Series** and **e Series** displays must contain **LightHouse** software release V4.32 or later.
- All networked **gS Series** displays must contain **LightHouse** software release V7.43 or later.

Note: The a6x and a7x variant **a Series MFDs** cannot be networked using **NMEA 0183**.

Master / repeater operation

- Any network featuring more than 1 **MFD** must have 1 of the displays designated as the data master.
- The data master display will receive data through **NMEA 0183** and / or **SeaTalk^{ng}**®, and bridge the data over **SeaTalk^{hs}** to other networked displays.

Homescreen sharing

- When networked, **MFDs** can share a homescreen.

Cartography sharing

- The cartography contained on chart cards is always used in preference to the embedded world base map when a chart card is inserted into a card slot.
- Chart card cartography can be shared between **MFDs**.

Radar operation

- **MFDs** support the use of up to 2 Radar scanners simultaneously.
- The data supplied by a connected Radar scanner(s) is repeated to any networked displays.

Note: All **MFDs** must have **LightHouse II** Release V12.xx software or later to enable multiple radar support.

Sonar / DownVision™ / SideVision™ operation

- You can connect an external sonar module unit to the **MFD** via the **SeaTalk^{hs}** network.
- Sonar and **DownVision™** variant **MFDs** include an internal sonar module which enables direct connection to a compatible transducer.
- You can have multiple active sonar modules (internal and external) on a network. You must select the sonar module / channel you want to use from the Fishfinder application menu.
- The data supplied by the sonar module is repeated to all networked displays.

Note:

- All **MFDs** must have **LightHouse II** Release V10.41 software or later to enable multiple sonar support.
- Sonar modules should be updated to the latest available software version to ensure compatibility.

Incompatible displays

If you connect a multifunction display to your system that is not compatible a warning message will be displayed until you disconnected the incompatible device from your network.

3rd generation multifunction displays are not compatible with the following Raymarine displays:

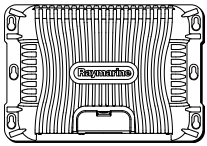
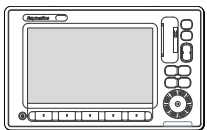
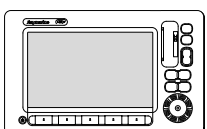
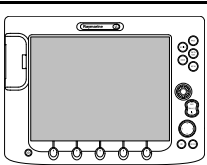
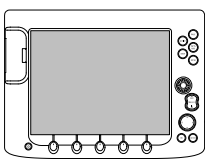
Product Image	Multifunction display	Generation
	G-Series	2 nd generation
	E-Series Widescreen	2 nd generation
	C-Series Widescreen	2 nd generation
	E-Series Classic	1 st generation
	C-Series Classic	1 st generation

3.6 Typical systems

The illustrations below show examples of possible system configurations.

For more details on compatible devices please refer to [3.1 System integration](#).

Example: Basic system

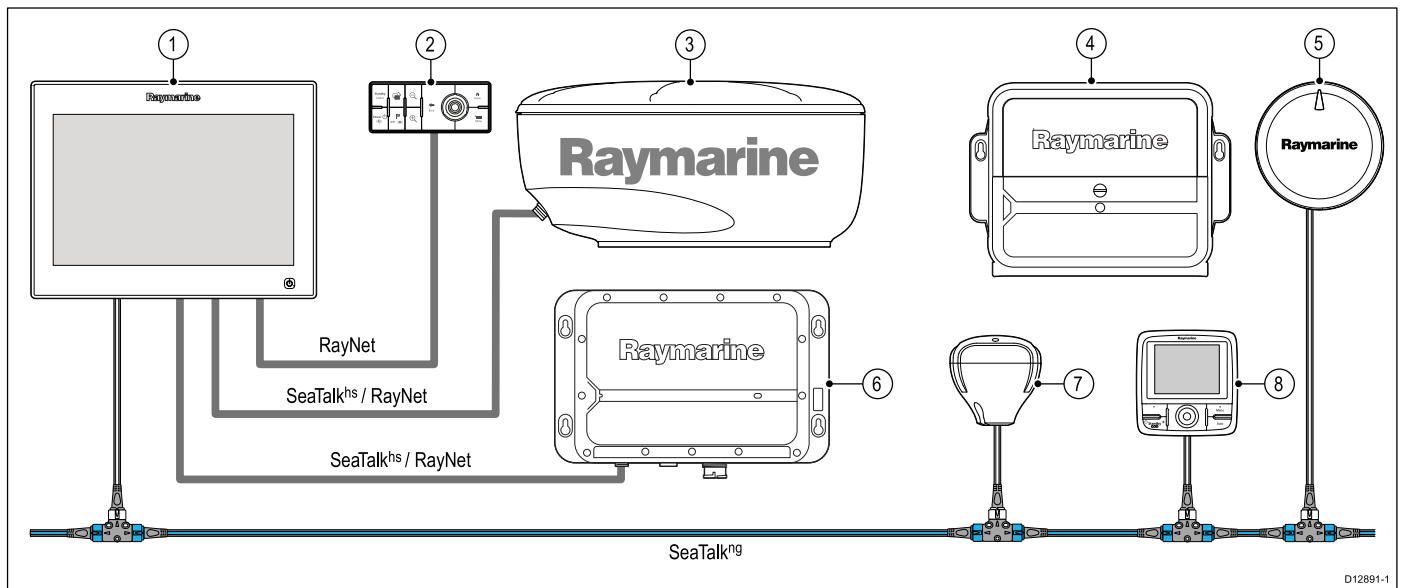

1. Multifunction display.
2. RMK-9 remote keypad.
3. Radar scanner.
4. Actuator Control Unit (ACU).
5. Attitude Heading Reference Sensor (AHRS).
6. Sonar module.
7. GPS receiver.
8. SeaTalk^{ng} pilot controller (optional).

Example: Expanded system

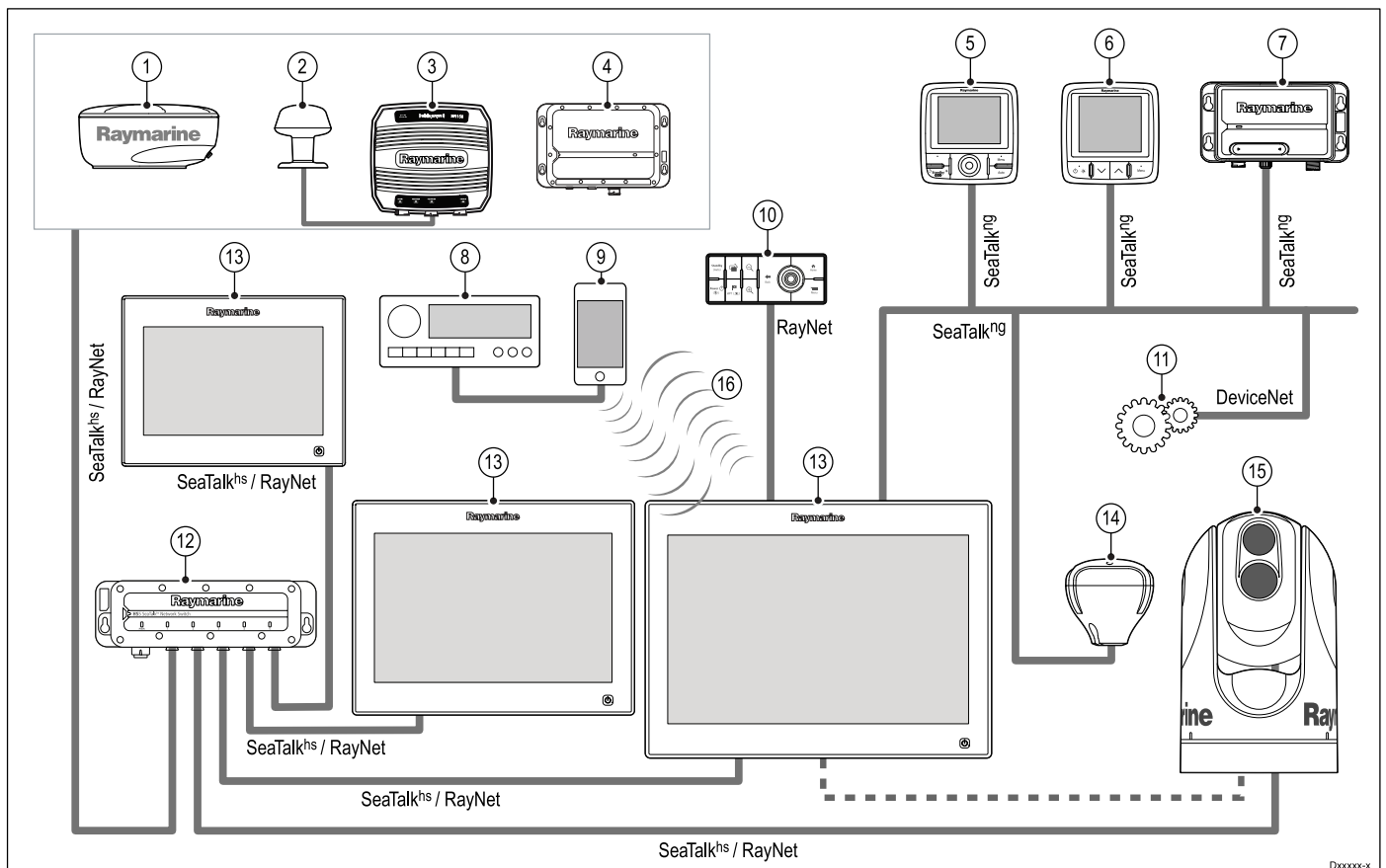

1. Radar scanner.

2. Weather sensor.
3. Sirius weather receiver.
4. Sonar module.
5. SeaTalk^{ng} Pilot controller.
6. SeaTalk^{ng} Instrument display.
7. AIS receiver / transceiver.
8. Audio system.
9. Smartphone / tablet.
10. Remote keypad.
11. DeviceNet spur (for NMEA 2000 devices).
12. Network switch.
13. Multifunction display.
14. GPS receiver.
15. Thermal camera.
16. Wireless connection.

3.7 System protocols

Your Multifunction Display can connect to various instruments and displays to share information and so improve the functionality of the system. These connections may be made using a number of different protocols. Fast and accurate data collection and transfer is achieved by using a combination of the following data protocols:

- SeaTalk^{hs}
- SeaTalk^{ng}
- NMEA 2000
- SeaTalk
- NMEA 0183

Note: You may find that your system does not use all of the connection types or instrumentation described in this section.

SeaTalk^{hs}

SeaTalk^{hs} is an ethernet based marine network. This high speed protocol allows compatible equipment to communicate rapidly and share large amounts of data.

Information shared using the SeaTalk^{hs} network includes:

- Shared cartography (between compatible displays).
- Digital radar data.
- Sonar data.

Seata^{ng}

SeaTalk^{ng} (Next Generation) is an enhanced protocol for connection of compatible marine instruments and equipment. It replaces the older SeaTalk and SeaTalk² protocols.

SeaTalk^{ng} utilizes a single backbone to which compatible instruments connect using a spur. Data and power are carried within the backbone. Devices that have a low draw can be powered from the network, although high current equipment will need to have a separate power connection.

SeaTalk^{ng} is a proprietary extension to NMEA 2000 and the proven CAN bus technology. Compatible NMEA 2000 and SeaTalk / SeaTalk² devices can also be connected using the appropriate interfaces or adaptor cables as required.

NMEA 2000

NMEA 2000 offers significant improvements over NMEA 0183, most notably in speed and connectivity. Up to 50 units can simultaneously transmit and receive on a single physical bus at any one time, with each node being physically addressable. The standard was specifically intended to allow for

a whole network of marine electronics from any manufacturer to communicate on a common bus via standardized message types and formats.

SeaTalk

SeaTalk is a protocol which enables compatible instruments to connect to each other and share data.

The SeaTalk cable system is used to connect compatible instruments and equipment. The cable carries power and data and enables connection without the need for a central processor.

Additional instruments and functions can be added to a SeaTalk system, simply by plugging them into the network. SeaTalk equipment can also communicate with other non-SeaTalk equipment via the NMEA 0183 standard, provided a suitable interface is used.

NMEA 0183

The NMEA 0183 Data Interface Standard was developed by the National Marine Electronics Association of America. It is an international standard to enable equipment from many different manufacturers to be connected together and share information.

The NMEA 0183 standard carries similar information to SeaTalk. However it has the important difference that one cable will only carry information in one direction. For this reason NMEA 0183 is generally used to connect a data receiver and a transmitter together, e.g. a compass sensor transmitting heading to a radar display. This information is passed in 'sentences', each of which has a three letter sentence identifier. It is therefore important when checking compatibility between items that the same sentence identifiers are used some examples of which are:

- VTG - carries Course and Speed Over Ground data.
- GLL - carries latitude and longitude.
- DBT - carries water depth.
- MWV - carries relative wind angle and wind speed data.

NMEA Baud rates

The NMEA 0183 standard operates at a number of different speeds, depending upon the particular requirement or equipment capabilities. Typical examples are:

- 4800 baud rate. Used for general purpose communications, including FastHeading data.
- 38400 baud rate. Used for AIS and other high speed applications.

3.8 Data master

Any system containing more than one networked multifunction display must have a designated data master.

The data master is the display which serves as a primary source of data for all displays, it also handles all external sources of information. For example the displays may require heading information from the autopilot and GPS systems, usually received through a SeaTalk^{ng} or NMEA connection. The data master is the display to which the SeaTalk, NMEA and any other data connections are made, it then bridges the data to the SeaTalk^{hs} network and any compatible repeat displays. Information shared by the data master includes:

- Cartography
- Routes and waypoints
- Radar
- Sonar
- Data received from the autopilot, instruments, the engine and other external sources.

Your system may be wired for redundancy with data connections made to repeat displays. However these connections will only become active in the event of a fault and/or reassignment of the data master.

In an autopilot system which does not contain a dedicated pilot control head the Data master also acts as the control for the autopilot.

3.9 Parts supplied

The following parts are supplied with your product.

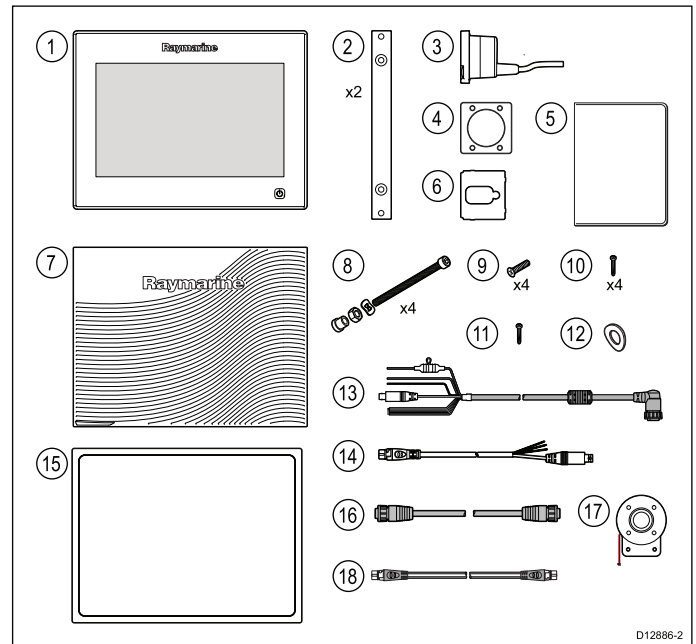

1	Multifunction display
2	2 x Display mounting brackets
3	RCR-2 Remote Card Reader
4	Mounting gasket for RCR-2
5	Document pack
6	RCR-2 inlay card x 2
7	Sun cover
8	4 x Mounting bolts, washers, lock nuts and feet
9	4 x Bracket fixings <ul style="list-style-type: none"> • gS95 = M5 x 25 pan head • gS125 and gS165 = M5 x 25 countersunk • gS195 = M5 x 60 countersunk
10	4 x RCR-2 fixings (self-tapping screws)
11	M5 x 10 pan head screw (not supplied with gS95)
12	M5 Wavy washer (for additional grounding strap)
13	1.5 m (4.9 ft) Power / Data cable
14	2 m (6.6 ft) Video / Alarm cable
15	Display mounting gasket
16	2 m (6.6 ft) RayNet cable
17	Auxiliary alarm
18	1m (3.28 ft) SeaTalk ^{ng} spur cable

HD-SDI additional parts supplied

The gS195 is supplied with the following additional parts for use with the HD-SDI connection.

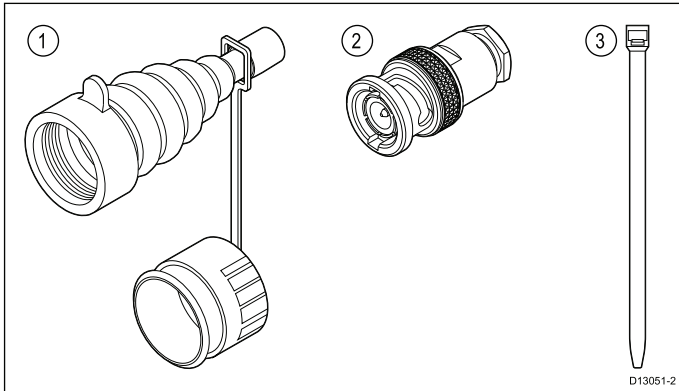

1	Protective boot
2	75 ohm BNC connector
4	Cable ties x 2 (to secure the protective boot)

3.10 Tools required for installation

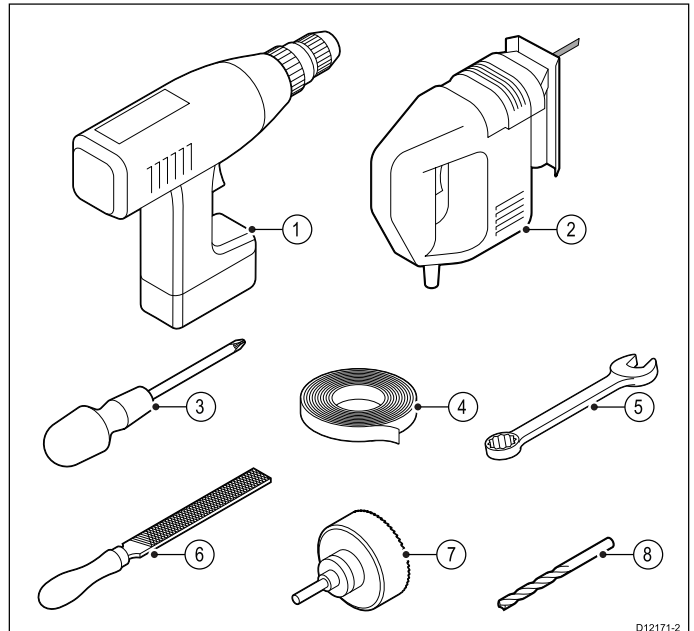

1. Power drill.
2. Jigsaw.
3. Pozidrive screwdriver.
4. Adhesive tape.
5. Spanner for surface mounting or bracket mounting fixings.
6. File.
7. Hole saw for flush mounting (For hole saw size refer to your product's mounting template).
8. Drill bit for surface mounting or flush mounting.

Additional tools for Flush mounting

For best results when flush mounting the displays it is recommended that a router is used to cut out the rebate.

3.11 Selecting a location



Warning: Potential ignition source
 This product is NOT approved for use in hazardous/flammable atmospheres. Do NOT install in a hazardous/flammable atmosphere (such as in an engine room or near fuel tanks).

General location requirements

When selecting a location for your product it is important to consider a number of factors.

Key factors which can affect product performance are:

- **Ventilation**

To ensure adequate airflow:

- Ensure that product is mounted in a compartment of suitable size.
- Ensure that ventilation holes are not obstructed. Allow adequate separation of all equipment.

Any specific requirements for each system component are provided later in this chapter.

- **Mounting surface**

Ensure product is adequately supported on a secure surface. Do not mount units or cut holes in places which may damage the structure of the vessel.

- **Cabling**

Ensure the product is mounted in a location which allows proper routing, support and connection of cables:

- Minimum bend radius of 100 mm (3.94 in) unless otherwise stated.
- Use cable clips to prevent stress on connectors.
- If your installation requires multiple ferrites to be added to a cable then additional cable clips should be used to ensure the extra weight of the cable is supported.

- **Water ingress**

The product is suitable for mounting both above and below decks. Although the unit is waterproof, it is good practice to locate it in a protected area away from prolonged and direct exposure to rain and salt spray.

- **Electrical interference**

Select a location that is far enough away from devices that may cause interference, such as motors, generators and radio transmitters / receivers.

- **Power supply**

Select a location that is as close as possible to the vessel's DC power source. This will help to keep cable runs to a minimum.

Compass safe distance

To prevent potential interference with the vessel's magnetic compasses, ensure an adequate distance is maintained from the display.

When choosing a suitable location for the multifunction display you should aim to maintain the maximum possible distance between the display and any compasses. Typically this distance should be at least 1 m (3 ft) in all directions. However for some smaller vessels it may not be possible to locate the display this far away from a compass. In this situation, the following figures provide the minimum safe distance that should be maintained between the display and any compasses.

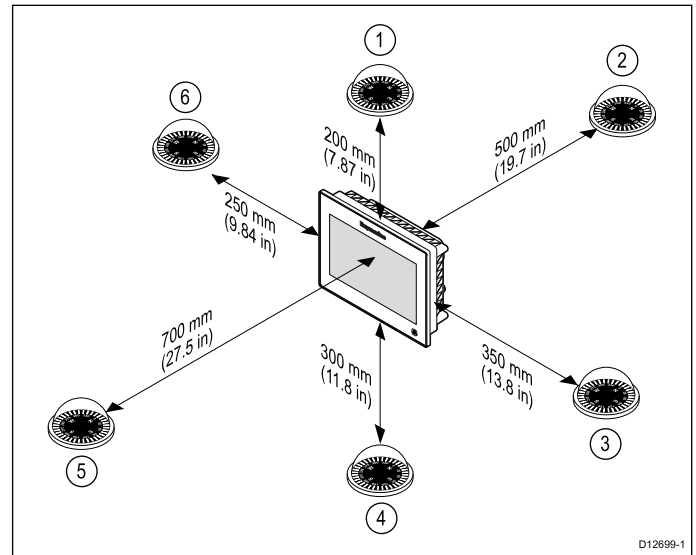

Item	Compass position in relation to display	Minimum safe distance from display
1	Top	200 mm (7.87 in.)
2	Rear	500 mm (19.7 in.)
3	Right-hand side	350 mm (13.8 in.)
4	Underside	300 mm (11.8 in.)
5	Front	700 mm (27.5 in.)
6	Left-hand side	250 mm (9.84 in.)

Caution: Mounting surface requirements

This product is heavy. To prevent potential damage to the product and / or your vessel, observe the following BEFORE installing the product:

- Refer to the weight information provided in the technical specification for this product and ensure that the intended mounting surface is suitable for bearing the weight.
- If the mounting surface is not suitable for the product weight, you may need to reinforce the mounting surface.
- If in doubt, refer to a professional marine equipment installer for further guidance.

1. **12 O'clock** — Standard orientation (In the 12 O'clock orientation the LCD is better viewed from top to bottom than it is from bottom to top.)
2. **6 O'clock** — Inverted orientation (In the 6 O'clock orientation the LCD is better viewed from bottom to top than it is from top to bottom.)

The table below details the LCD orientation for each gS Series MFD.

MFD	LCD orientation	MFD	LCD orientation
gS95 (E70124)	12 O'clock	gS95 INV (E70183)	6 O'clock
gS125 (E70125)	12 O'clock	gS125 INV (E70184)	6 O'clock
gS165 (E70126)	12 O'clock	gS165 INV (E70185)	6 O'clock
		gS195 (E70213)	6 O'clock

Viewing angle considerations

As display contrast, color and night mode performance are all affected by the viewing angle, Raymarine recommends you temporarily power up the display when planning the installation, to enable you to best judge which location gives the optimum viewing angle.

LCD orientation

Raymarine multifunction displays (MFDs) can be viewed from wide angles top to bottom and left to right.

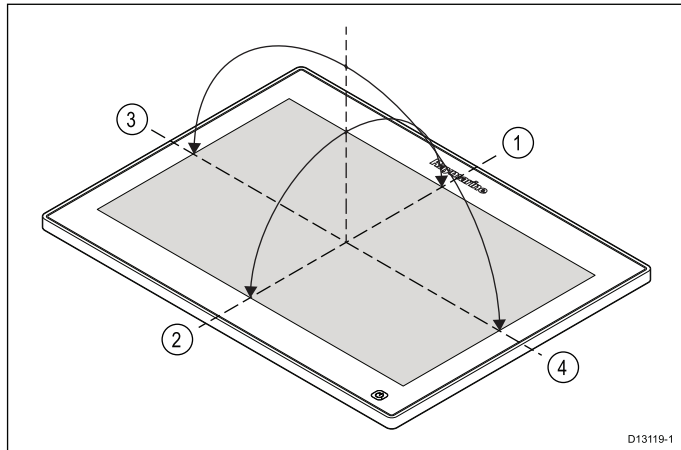

1. Top
2. Bottom
3. Left
4. Right

LCDs can be orientated in 2 directions:

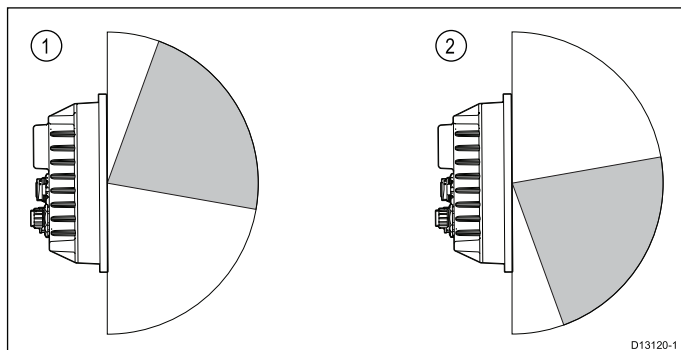

Product dimensions

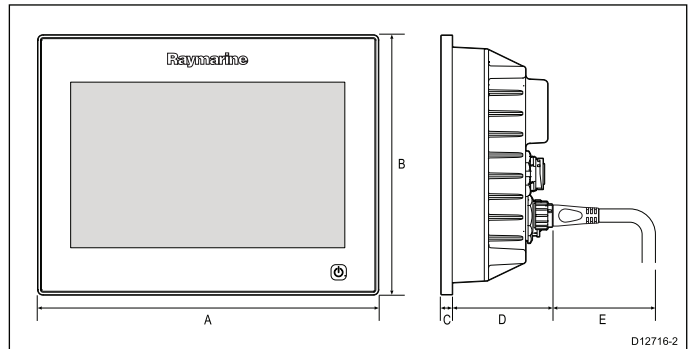

	gS95	gS125	gS165	gS195
A	246.8 mm (9.7 in)	311.8 mm (12.3 in)	383.2 mm (15 in)	433.9 mm (17.1 in)
B	188.2 mm (7.4 in)	237.1 mm (9.3 in)	284.7 mm (11.2 in)	391.2 mm (15.4 in)
C	8 mm (0.31 in)	8 mm (0.31 in)	8 mm (0.31 in)	8 mm (0.31 in)
D	69 mm (2.72 in)	70 mm (2.75 in)	69 mm (2.72 in)	75.9 mm (3 in)
E	114.1 mm (7.8 in)	114.1 mm (7.8 in)	114.1 mm (7.8 in)	114.1 mm (7.8 in)

Card reader dimensions

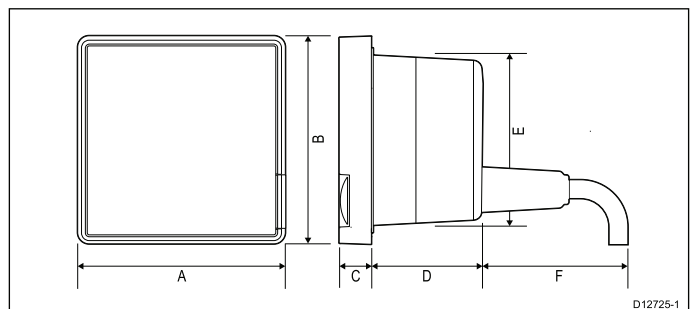

A	55 mm (2.17 in)
B	55 mm (2.17 in)
C	8.5 mm (0.33 in)

D	36 mm (1.4 in)
E	39.2 mm (1.5 in)
F	90 mm (3.5 in)

Chapter 4: Cables and connections

Chapter contents

- [4.1 General cabling guidance on page 46](#)
- [4.2 gS95 / gS125 / gS165 Connections overview on page 47](#)
- [4.3 gS195 connections overview on page 47](#)
- [4.4 Power connection on page 48](#)
- [4.5 Card reader connection on page 51](#)
- [4.6 Auxiliary alarm connection on page 51](#)
- [4.7 Network connections on page 52](#)
- [4.8 Keypad connection on page 54](#)
- [4.9 Radar connection on page 55](#)
- [4.10 Sonar module connection on page 57](#)
- [4.11 Thermal camera connection on page 59](#)
- [4.12 IP Camera connections on page 60](#)
- [4.13 Weather receiver connection on page 61](#)
- [4.14 Fusion link connection on page 61](#)
- [4.15 GPS connection on page 62](#)
- [4.16 AIS connection on page 63](#)
- [4.17 Fastheading connection on page 63](#)
- [4.18 SeaTalk^{ng} connections on page 64](#)
- [4.19 NMEA 2000 connection on page 65](#)
- [4.20 SeaTalk connection on page 65](#)
- [4.21 NMEA 0183 connection on page 66](#)
- [4.22 Camera / Video connections on page 67](#)
- [4.23 HDMI video output on page 67](#)
- [4.24 HD-SDI connection \(gS195\) on page 68](#)
- [4.25 Media player connection on page 69](#)
- [4.26 Bluetooth remote control connection on page 70](#)
- [4.27 Remote control functions on page 72](#)
- [4.28 WiFi connections on page 74](#)

4.1 General cabling guidance

Cable types and length

It is important to use cables of the appropriate type and length

- Unless otherwise stated use only standard cables of the correct type, supplied by Raymarine.
- Ensure that any non-Raymarine cables are of the correct quality and gauge. For example, longer power cable runs may require larger wire gauges to minimize voltage drop along the run.

Routing cables

Cables must be routed correctly, to maximize performance and prolong cable life.

- Do NOT bend cables excessively. Wherever possible, ensure a minimum bend diameter of 200 mm (8 in) / minimum bend radius of 100 mm (4 in).

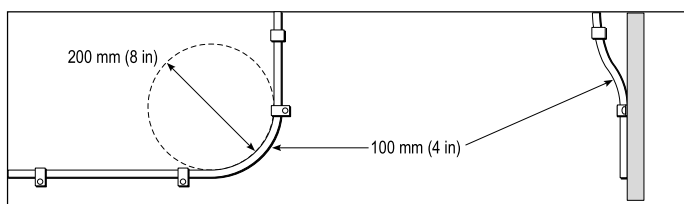

- Protect all cables from physical damage and exposure to heat. Use trunking or conduit where possible. Do NOT run cables through bilges or doorways, or close to moving or hot objects.
- Secure cables in place using tie-wraps or lacing twine. Coil any extra cable and tie it out of the way.
- Where a cable passes through an exposed bulkhead or deckhead, use a suitable watertight feed-through.
- Do NOT run cables near to engines or fluorescent lights.

Always route data cables as far away as possible from:

- other equipment and cables,
- high current carrying ac and dc power lines,
- antennae.

Strain relief

Ensure adequate strain relief is provided. Protect connectors from strain and ensure they will not pull out under extreme sea conditions.

Circuit isolation

Appropriate circuit isolation is required for installations using both AC and DC current:

- Always use isolating transformers or a separate power-inverter to run PC's, processors, displays and other sensitive electronic instruments or devices.
- Always use an isolating transformer with Weather FAX audio cables.
- Always use an isolated power supply when using a 3rd party audio amplifier.

- Always use an RS232/NMEA converter with optical isolation on the signal lines.
- Always make sure that PC's or other sensitive electronic devices have a dedicated power circuit.

Cable shielding

Ensure that all data cables are properly shielded that the cable shielding is intact (e.g. hasn't been scraped off by being squeezed through a tight area).

Cable suppression ferrites

To ensure optimum EMC performance and to comply with applicable EMC regulations the cables supplied with this product include suppression ferrites.

Two additional suppression ferrites are included for use when connecting additional RayNet cables (not supplied) to the display.

Fit a ferrite to each additional RayNet cable as shown below:

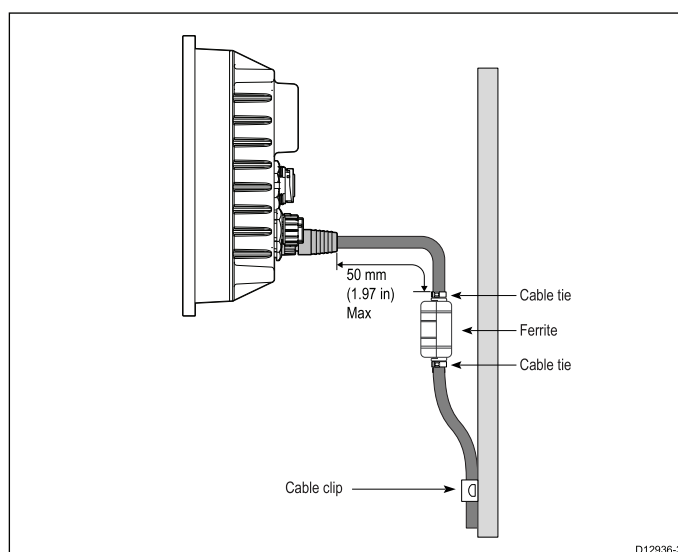

If you need to remove a ferrite for any reason, ensure it is replaced in its original location before using the product.

4.2 gS95 / gS125 / gS165 Connections overview

Details of the connections available on the multifunction display are shown below.

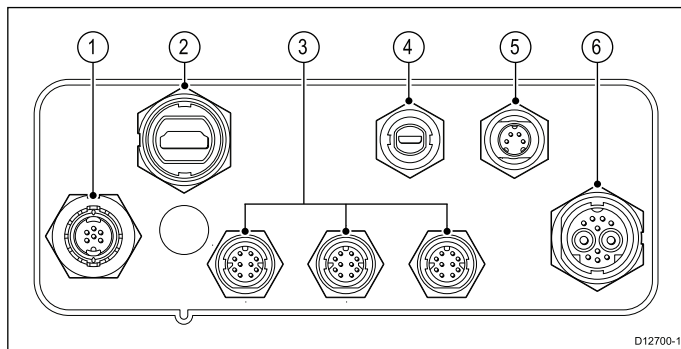

1	SeaTalk ^{ng}
2	HDMI
3	3 x PoE / RayNet SeaTalk ^{hs}
4	Card reader
5	Video in / Alarm Out
6	Power / NMEA 0183 / Video in

4.3 gS195 connections overview

Details of the connections available on the gS195 are shown below.

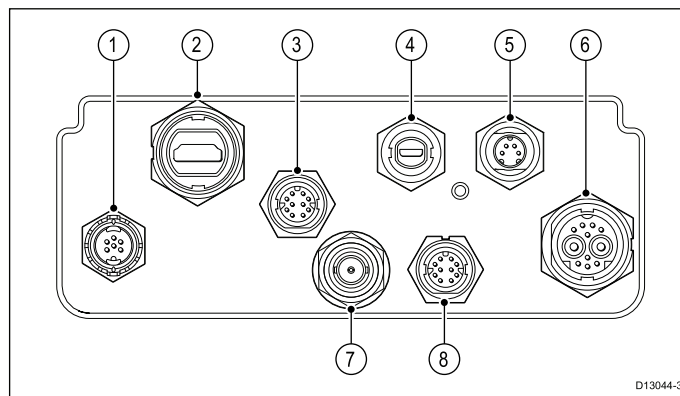

1	SeaTalk ^{ng} connection
2	HDMI Output
3	PoE / RayNet SeaTalk ^{hs} connection
4	Card reader connection
5	Analogue video Input / Alarm Output
6	Power / NMEA 0183 / Analogue video Input
7	HD-SDI Video Input
8	PoE / RayNet SeaTalk ^{hs} connection

Connector and cable protective caps

Unused connectors and disconnected cables should be adequately protected against damage.

Important:

The rear connectors on your product are fitted with protective caps which should be securely fitted over any connectors that are not going to be used / connected.

If any cables are to be left disconnected then, if available use the cables protective cap or insulation tape to protect the cable connector.

4.4 Power connection

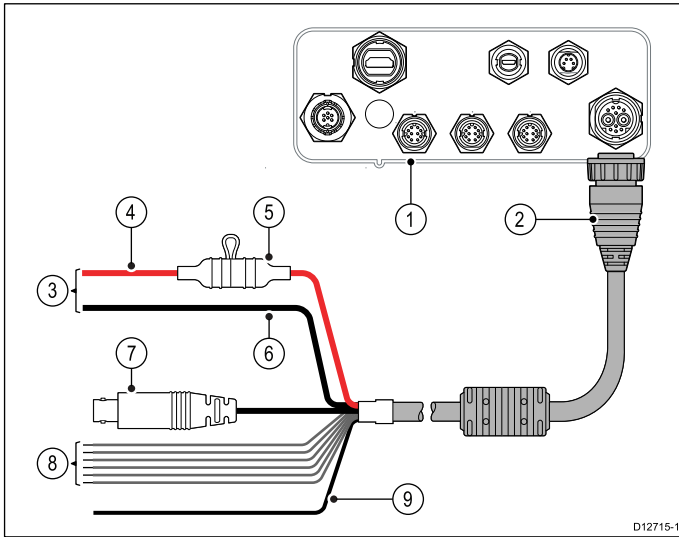

1. Multifunction display connections.
2. Power and data cable.
3. Connection to 12/24 V power supply.
4. Red cable (positive).
5. Fuse.
6. Black cable (negative).
7. Video input cable.
8. NMEA 0183 data cables.
9. Ground (drain) wire (thin black wire; must be connected to RF ground point).

Power distribution

Raymarine recommends that all power connections are made via a distribution panel.

- All equipment must be powered from a breaker or switch, with appropriate circuit protection.



Warning: Product grounding

Before applying power to this product, ensure it has been correctly grounded, in accordance with the instructions provided.

Grounding — Dedicated drain wire

The power cable supplied with this product includes a dedicated shield (drain) wire for connection to a vessel's RF ground point.

It is important that an effective RF ground is connected to the system. A single ground point should be used for all equipment. The unit can be grounded by connecting the shield (drain) wire of the power cable to the vessel's RF ground point. On vessels without an RF ground system the shield (drain) wire should be connected directly to the negative battery terminal.

The dc power system should be either:

- Negative grounded, with the negative battery terminal connected to the vessel's ground.
- Floating, with neither battery terminal connected to the vessel's ground



Warning: Positive ground systems

Do not connect this unit to a system which has positive grounding.

Breakers, fuses and circuit protection

The information below is provided as guidance to help protect your product. The example illustrations provided are for common vessel power arrangements, if you are unsure how to provide the correct level of protection then please consult a Raymarine authorized dealer for support.

Distribution panel connection

It is recommended that your product is wired through your vessel's distribution panel via a thermal breaker or fuse.

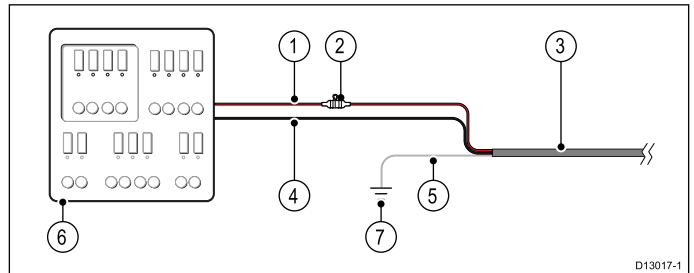

1. Vessel power supply positive (+)
2. In-line fuse. (If your products power cable does not have an in-line fuse then an one fuse should be fitted.)
3. Product power cable
4. Vessel power supply negative (-)
5. * Drain wire
6. Vessel distribution panel
7. Vessel RF ground point connection

Battery connection with RF ground

If your vessel does not have a distribution panel then your product may be wired directly to the battery with the drain wire connected to the vessel's RF ground point.

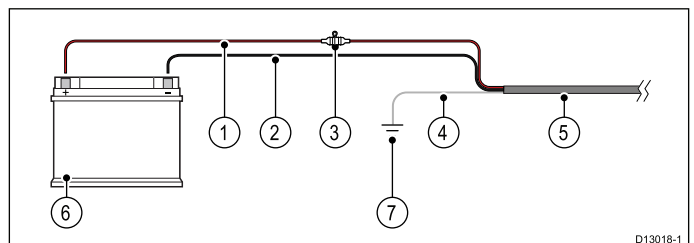

1. Vessel power supply positive (+)
2. Vessel power supply negative (-)
3. In-line fuse (If your products power cable does not have a built in fuse then an in-line fuse should be fitted.)
4. * Drain wire
5. Product power cable

- 6. Vessel battery
- 7. Vessel RF ground point connection

Battery connection with no RF ground

If your vessel does not have a distribution panel or an RF ground point then your product may be wired directly to the battery with the drain wire also connected to the battery's negative terminal.

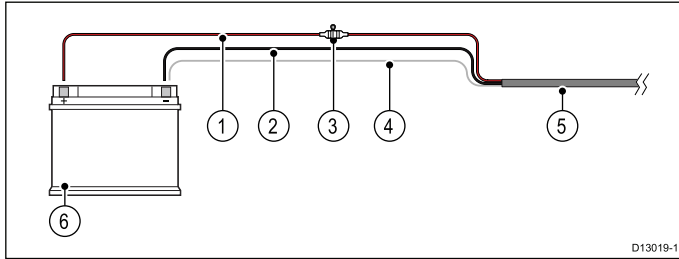

- 1. Vessel power supply positive (+)
- 2. Vessel power supply negative (-)
- 3. In-line fuse (If your products power cable does not have a built in fuse then an in-line fuse should be fitted.)
- 4. Drain wire connected to vessel negative power supply.
- 5. Product power cable
- 6. Vessel battery

In-line fuse and thermal breaker ratings

The following in-line fuse and thermal breaker ratings apply to your product:

In-line fuse rating	Thermal breaker rating
15 A	15 A (if only connecting one device)

Note:

- The suitable fuse rating for the thermal breaker is dependent on the number of devices you are connecting. If in doubt consult an authorized Raymarine dealer.
- Your product's power cable may have fitted in-line fuse, if not then you can add an in-line fuse to the positive wire of your products power connection.

Power cable

The display is supplied with a combined power and data multi cable, this can be extended if required.

Power cables available

Cable	Part number	Notes
1.5 m (4.9 ft) Straight power and data cable	R62379	
1.5 m (4.9 ft) Right angled power and data cable	R70029	

Cable extension

The following restrictions apply to any extension to the power cable:

- Cable must be of a suitable gauge for the circuit load.
- Each unit should have its own dedicated power cable wired back to the distribution panel.

Total length (max)	Supply voltage	Cable gauge (AWG)
0–5 m (0–16.4 ft)	12 V	18
	24 V	20
5–10 m (16.4–32.8 ft)	12 V	14
	24 V	18
10–15 m (32.8–49.2 ft)	12 V	12
	24 V	16
15–20 m (49.2–65.5 ft)	12 V	12
	24 V	14

Note: These distances are for a 2 wire power cable run from the battery to the display (approximately the distance from the battery to the display). To calculate the round trip length, double the figure stated here.

Sharing a breaker

Where more than 1 piece of equipment shares a breaker you must provide protection for the individual circuits. E.g. by connecting an in-line fuse for each power circuit.

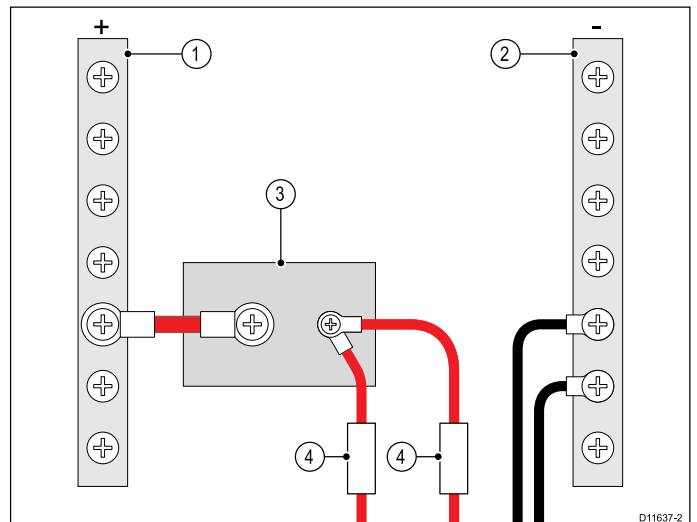

1	Positive (+) bar
2	Negative (-) bar
3	Circuit breaker
4	Fuse

Where possible, connect individual items of equipment to individual circuit breakers. Where this is not possible, use individual in-line fuses to provide the necessary protection.

Touchscreen interference

In exceptional circumstances, due to the proximity of certain electronic equipment that may be on the vessel the touchscreen may become unresponsive due to electrical interference.

In the unlikely event of this occurring the interference can be suppressed by adding a grounding strap (not supplied) to the rear case of the multifunction display.

The grounding strap should be connected to the vessel's RF ground point, or where no ground point exists to the negative terminal of the vessel's power supply. The minimum recommended cable thickness to be used for the grounding strap is 14AWG.

Note:

All 4 holes contain plastic screws. The plastic screws should be removed as follows:

- **gS95** — ALL 4 plastic screws must be removed to enable the mounting brackets to be attached.
- **gS125 / gS165 / gS195** — The plastic screw should ONLY be removed from the location you want to use for the grounding strap point.

Do NOT use the plastic screws for attaching mounting brackets or the ground strap.

Note: On a gS95 the grounding points are the same holes used for the mounting bracket securing bolts.

The grounding strap should be fitted as shown below.

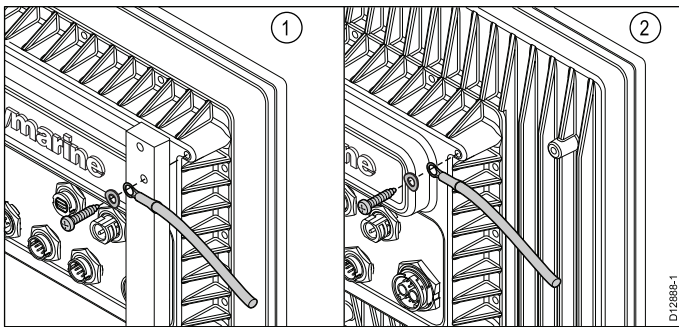

1	Fitting grounding strap to a gS95.
2	Fitting grounding strap to a gS125, gS165, or gS195.

An extra screw and washer has been provided for the gS125, gS165 and gS195 to secure the grounding strap to the rear case.

The grounding strap can be connected to any of the locations shown below.

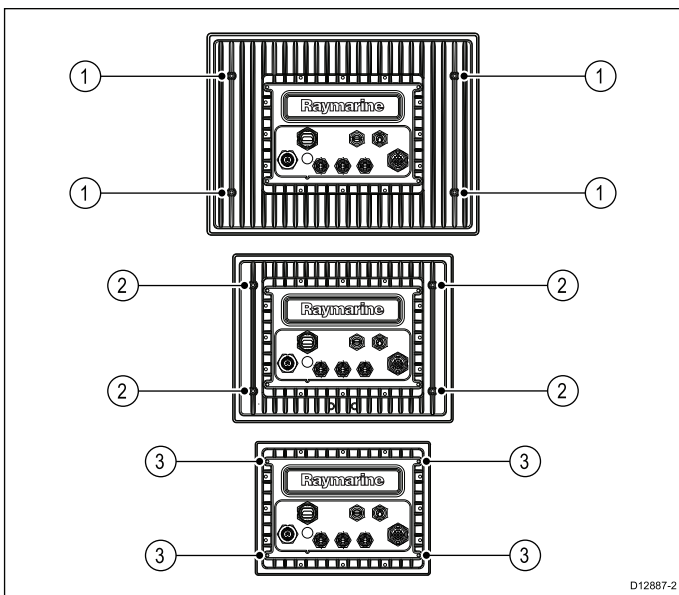

1	gS165 and gS195 grounding strap points
2	gS125 grounding strap points
3	gS95 grounding strap points

4.5 Card reader connection

The card reader must be connected directly to the dedicated card reader connector on the rear of the display.

Note: Do not use cable extensions when connecting the card reader to the display.

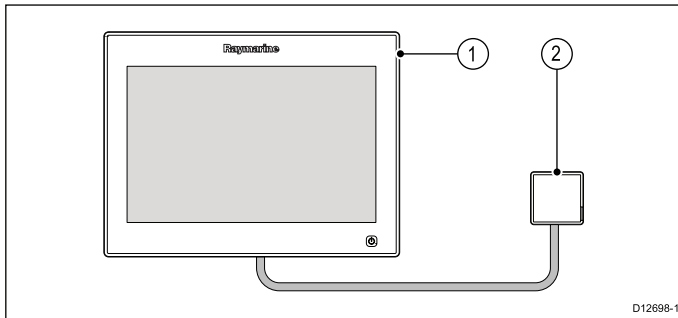

- Multifunction display.
- Card reader.

Note: The card reader must be connected directly to the display.

4.6 Auxiliary alarm connection

The auxiliary alarm (supplied) can be connected to the Video in / Alarm out connector of the multifunction display.

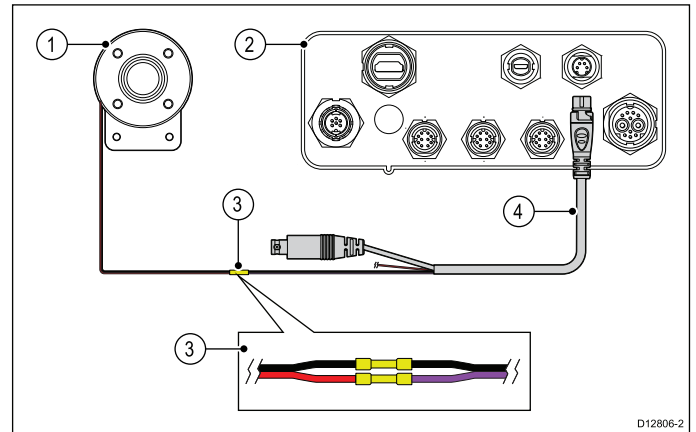

1. Auxiliary alarm (supplied).
2. Multifunction display rear connector panel.
3. Connection — Wires should be connected **Black to Black and Red to Purple**.
4. Video In / Alarm out cable (supplied).

The auxiliary alarm to cable connection should be made using suitable connectors (e.g. crimps). To prevent damage due to water ingress ensure the connection is watertight.

4.7 Network connections

You can connect a number of digital devices to your multifunction display using the Network connector(s) at the rear of the unit.

A typical network of digital devices may include:

- Up to 6 Raymarine multifunction displays.
- SeaTalk^{hs} and RayNet digital devices such as a sonar module and radar scanner.
- Ethernet devices such as IP cameras.

Your multifunction display includes 3 network connectors which also provide Power over Ethernet (PoE). Networks requiring additional network connections will require a Raymarine network switch.

Typical SeaTalk^{hs} network

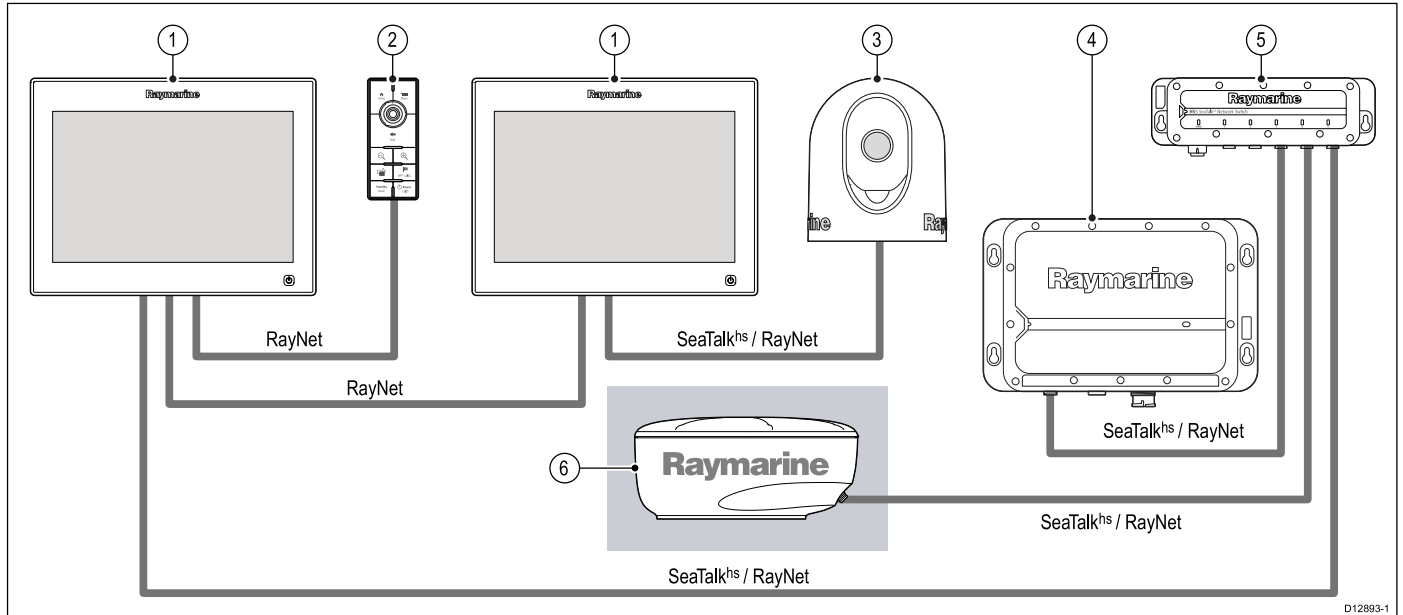

1. gS Series multifunction display.
2. Remote keypad (PoE).
3. Thermal camera (PoE).
4. Sonar module.
5. Network switch.
6. Radar scanner.

In the example above both the Remote control and thermal camera are supplied Power over Ethernet (PoE) by the gS displays.

Note: The RayNet cable supplied with the display includes a suppression ferrite. 2 additional suppression ferrites are supplied with the display, these must be used on any additional network connections.

Network cable connector types

There are 2 types of network cable connector — SeaTalk^{hs} and RayNet.

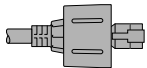
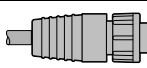
	SeaTalk^{hs} connector — used for connecting SeaTalk ^{hs} devices to a Raymarine network switch via SeaTalk ^{hs} cables.
	RayNet connector — used for connecting Raymarine network switches and SeaTalk ^{hs} devices to the multifunction display via RayNet cables. Also required for connecting a crossover coupler if only one device is being connected to the display's Network connector.

Power over Ethernet (PoE)

This product can supply Power over Ethernet (PoE) to class 1, 2 and 3 devices. The product can output a maximum of 20 Watts for consumption by PoE devices.

The PoE class denotes the power range of the PoE device.

PoE Class	Power range	Class description
Class 1	0.44 W to 3.84 W	Very low power
Class 2	3.84 W to 6.49 W	Low power
Class 3	6.49 W to 12.95 W	Mid power
Class 0	0.44 W to 12.95 W	-

Note: The product will not provide power to class 4 devices.

The product can power up to 3 devices using the available network / PoE ports as long as the combined max power of the PoE devices does not exceed 20 watts.

When a PoE device is connected it is interrogated to establish if the device is PoE and if so what class of device it is. The max power for that class of device is then assigned to that port (e.g. class 2 = 6.49 W) and deducted from the remaining power output.

The table below shows acceptable configurations of PoE devices.

Class 1 (3.84 W)	Class 2 (6.49 W)	Class 3 / Class 0 (12.95 W)	Total power used
1			3.84 W
2			7.68 W
3			11.52 W
	1		6.49 W
	2		12.98 W
	3		19.47 W
1	1		10.33 W
2	1		14.17 W
1	2		16.82 W
		1	12.95 W
1		1	16.79 W
	1	1	19.44 W

Note: A class 0 device shall be assigned the same power allocation as a class 3 device.

Note: If a PoE device is connected that will take the total assigned power over 20 W the device will not be powered.

4.8 Keypad connection

The keypad can be connected directly to a multifunction display's network connector or via a network switch. Multiple keypads can be connected to a system. Each keypad can be used to control up to 4 multifunction displays. If the network does not provide Power over Ethernet (PoE) then the keypad must be powered separately.

Direct connection — gS Series multifunction display

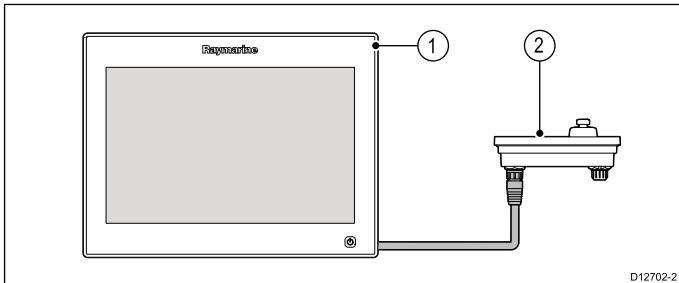

1. gS Series multifunction display.
2. Keypad.

When connecting the keypad directly to a gS Series multifunction display the keypad is supplied with PoE, from the multifunction display.

Direct connection — Raymarine multifunction display

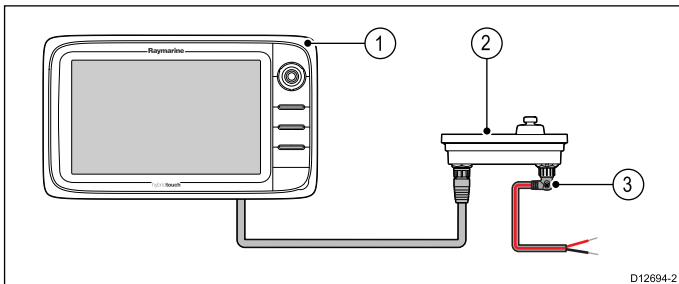

1. Multifunction display.
2. Keypad.
3. Right angled power cable.

When connecting the keypad directly to a New a Series, New c Series or New e Series multifunction display the keypad is not supplied with PoE, and so requires power using the alternate power connector.

Network connection — gS Series multifunction displays

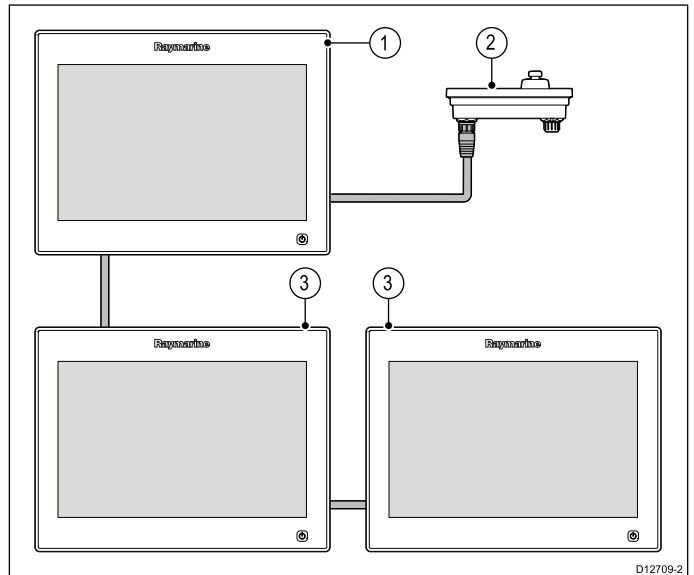

1. gS Series multifunction display (supplying PoE to the keypad).
2. Keypad.
3. Networked gS Series multifunction displays.

When connecting the keypad to a gS Series multifunction display network the keypad is supplied with PoE.

Network connection — Raymarine multifunction displays

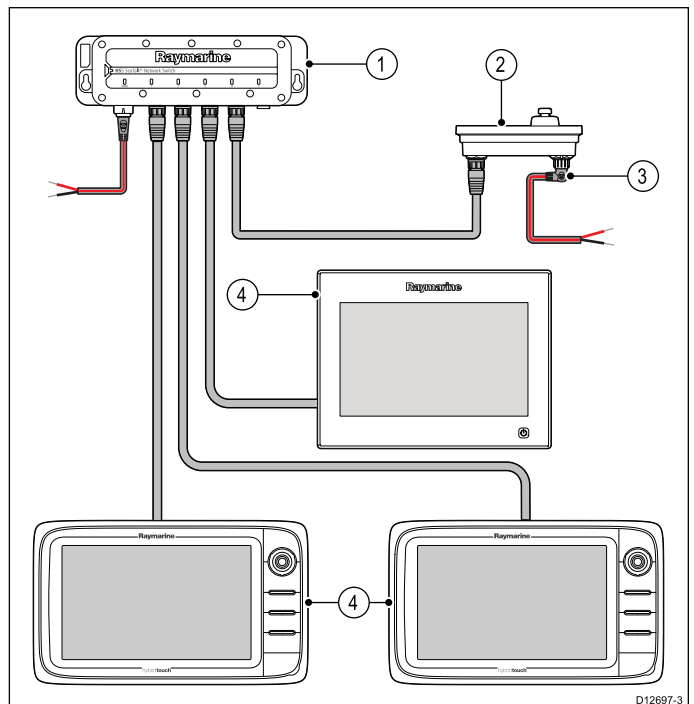

1. Network switch.
2. Keypad.
3. Right angled power cable.
4. Networked multifunction displays.

When connecting the keypad to a network switch the keypad requires a separate power supply using the alternate power connector.

Once connected the keypad must be paired with the each multifunction display you want to control using the keypad.

4.9 Radar connection

The multifunction display is compatible with Raymarine Non-HD digital radomes and HD / SuperHD radar scanners. The scanner is connected using over SeaTalk^{hs}.

The radar is usually connected via a Raymarine network switch. On smaller systems (with only 3 network devices) the radar may be connected directly to the display.

Radar connected using Raymarine network switch

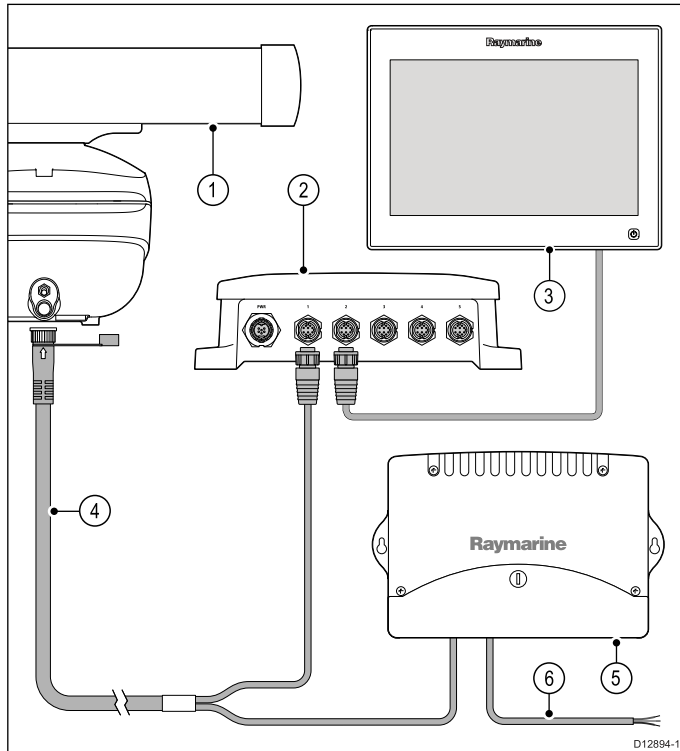

1. Radar scanner.
2. Raymarine network switch.
3. gS multifunction display.
4. RayNet radar cable.
5. VCM (Voltage Converter Module) — **required for Open Arrays.**
6. Power connection.

Radar cable extension

For longer cable runs a radar power and data digital cable extension is required.

Radar connected directly to the display

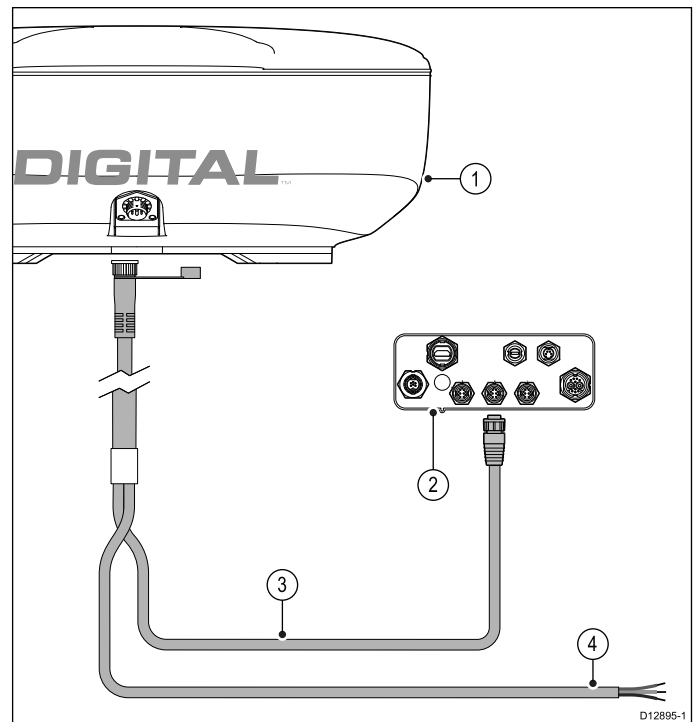

1. Radar scanner
2. Multifunction display rear connector panel.
3. RayNet Radar cable.
4. Connection to power supply — **Open array scanners require a VCM (Voltage Converter Module).**

RJ45 SeaTalk^{hs} Radar cable connection

To connect a Radar using an RJ45 SeaTalk^{hs} radar cable additional accessories are required.

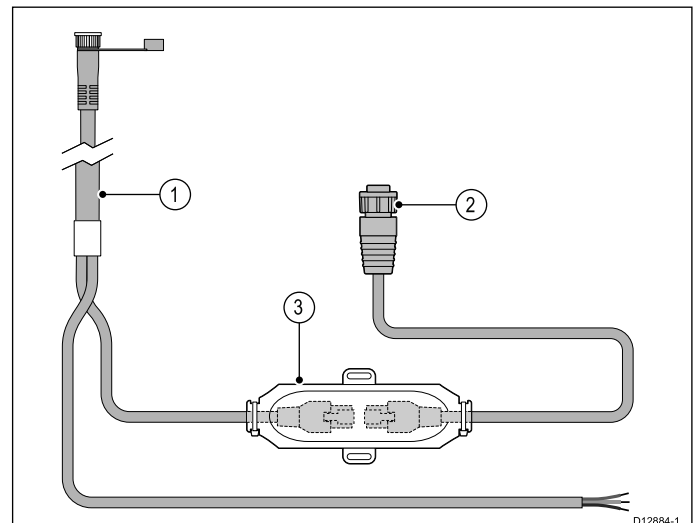

1. RJ45 SeaTalk^{hs} Radar cable.
2. RayNet to RJ45 SeaTalk^{hs} adaptor cable.
3. SeaTalk^{hs} crossover coupler.

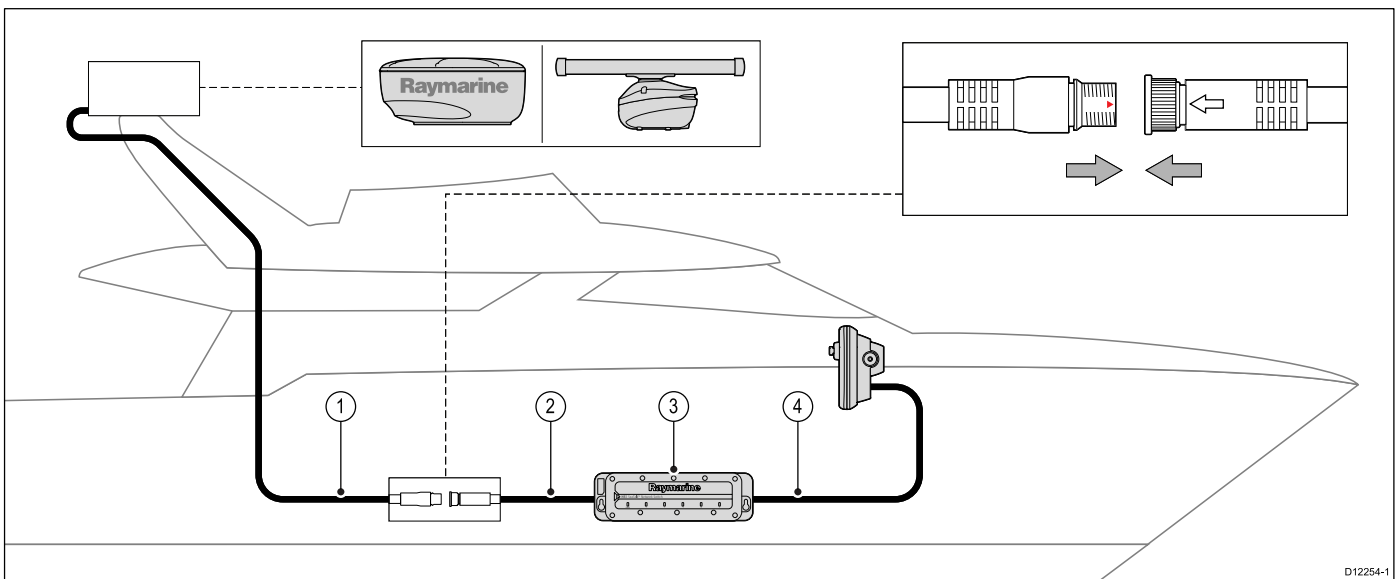

D12254-1

1. Radar extension cable.
2. Radar power and data digital cable.
3. Raymarine network switch (or crossover coupler if connecting radar directly to display).
4. RayNet cable (or RayNet to SeaTalk^{hs} cable if connecting via crossover coupler).

Note: The extension cable connects to the radar scanner.

Note: The power connection is NOT shown in the diagram. If using an Open Array scanner a VCM (Voltage Converter Module) must be connected between the scanner and the power supply.

Digital radar cables

You will need a dedicated radar power and data digital cable and appropriate network cables to connect your scanner to your system.

Connection	Required cable
Radar scanner to power supply and Raymarine network switch.	Power and data digital cable. For longer cable runs, extensions are available in a variety of lengths.
Raymarine network switch to multifunction display.	Network cables, available in a variety of cable lengths.

SeaTalk^{hs} Radar power and data digital cables

These cables contain the wires for a scanner's power and data connections.

Cable	Part number
RJ45 SeaTalk ^{hs} 5 m (16.4 ft) Power and data digital cable	A55076D
RJ45 SeaTalk ^{hs} 10 m (32.8 ft) Power and data digital cable	A55077D
RJ45 SeaTalk ^{hs} 15 m (49.2 ft) Power and data digital cable	A55078D
RJ45 SeaTalk ^{hs} 25 m (82.0 ft) Power and data digital cable	A55079D

Note: The maximum length for the radar power and data digital cable (including any extensions) is 25 m (82 ft).

RayNet Radar power and data digital cables

These cables contain the wires for a scanner's power and data connections.

Cable	Part number
RayNet 5 m (16.4 ft) Power and data digital cable	A80227
RayNet 10 m (32.8 ft) Power and data digital cable	A80228
RayNet 15 m (49.2 ft) Power and data digital cable	A80229
RayNet 25 m (82.0 ft) Power and data digital cable	A80230

Note: The maximum length for the radar power and data digital cable (including any extensions) is 25 m (82 ft).

Radar power and data digital extension cables

These cables extend the power and data digital cables for a scanner's power and data connections.

Cable	Part number
2.5 m (8.2 ft) Power and data digital cable	A92141D
5 m (16.4 ft) Power and data digital cable	A55080D
10 m (32.8 ft) Power and data digital cable	A55081D

Note: The maximum length for the radar power and data digital cable (including any extensions) is 25 m (82 ft).

4.10 Sonar module connection

A sonar connection is required for fishfinder applications.

The multifunction display can be used with the following sonar modules:

- CP450C
- CP300
- CP100

Note: You must ensure that the cable ends connected into the display and sonar module have a locking / weather-tight mechanism.

Direct sonar module connection

On smaller systems (with only 3 network devices) the sonar module may be connected directly to the display.

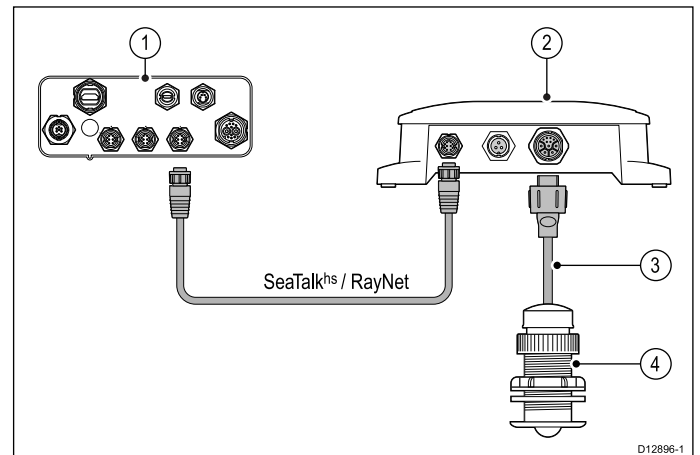

1. Multifunction display rear connector panel.
2. Sonar module.
3. Sonar transducer cable.
4. Sonar transducer.

Sonar module connection using a network switch

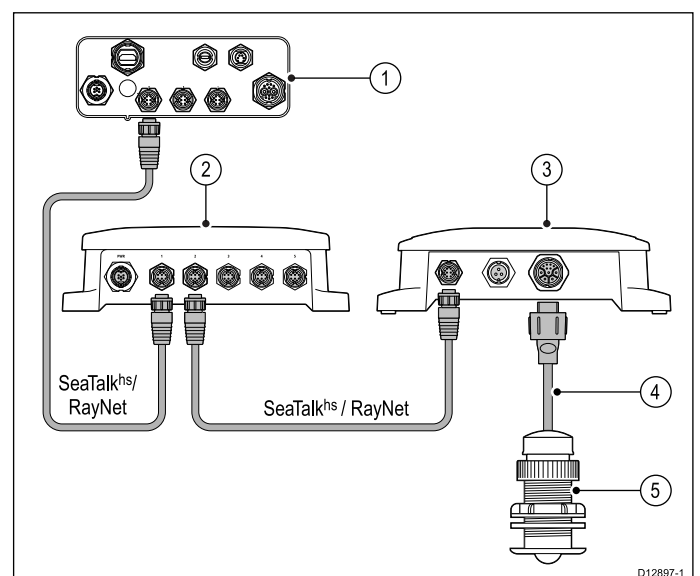

1. Multifunction display rear connector panel.
2. Network switch.
3. Sonar module.
4. Sonar transducer cable.
5. Sonar transducer.

Sonar variant multifunction display connection

The gS Series multifunction display can also be networked to Raymarine multifunction display that has a built-in sonar module.

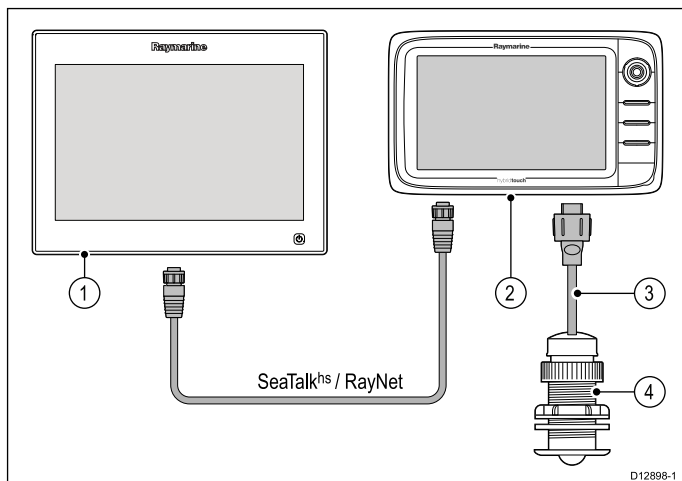

1. gS multifunction display.
2. Sonar Variant multifunction display (e.g. e97).
3. Sonar transducer cable.
4. Sonar transducer.

Multiple sonar modules

Up to 3 sonar modules can be connected on the same network, you must select which sonar module you want to use as only 1 sonar module can be viewed on the multifunction display at any one time.

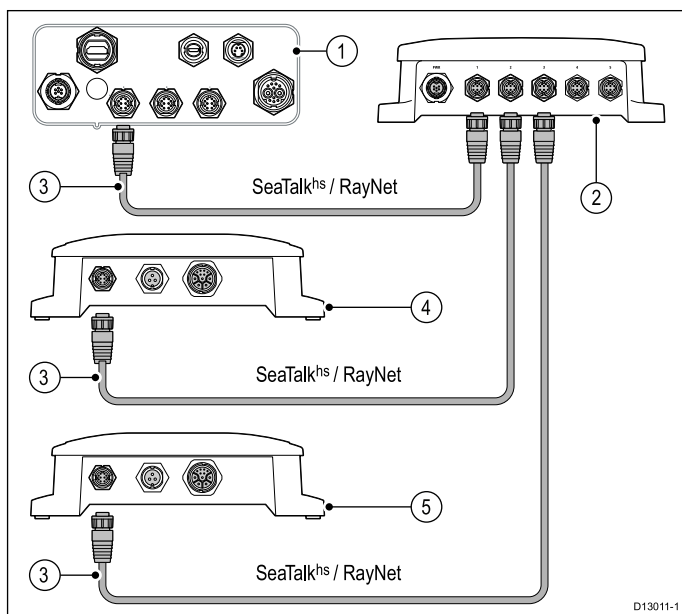

1. Multifunction display rear connector panel.
2. network switch.
3. RayNet network cables.
4. CP450C CHIRP sonar module
5. CP100 DownVision™ sonar module

Sonar variant multifunction displays

The table below details which multifunction display variants feature a built-in sonar module and can be connected directly to compatible sonar transducers.

Non-sonar variants	Sonar variants	DownVision™ variants
a65	a67	a68
a65 Wi-Fi	a67 Wi-Fi	a68 Wi-Fi
a75	a77	a78
a75 Wi-Fi	a77 Wi-Fi	a78 Wi-Fi
a95	a97	a98
a125	a127	a128
e7	e7D	
c95	c97	
c125	c127	
e95	e97	
e125	e127	
e165		

Important software requirements for multiple sonar systems

If your system includes more than one source of sonar data you must ensure that any CP300 or CP450C sonar modules are running software version **v4.04** or later.

This applies to systems which include:

- Any number of MFD(s) with an internal sonar module plus a CP300 and / or CP450C sonar module; or
- No MFD(s) with an internal sonar module, but more than one CP300 or CP450C sonar module.

This does NOT apply to any systems that do NOT include a CP300 or CP450C sonar module.

Note: For software downloads and instructions on how to update the software for your product(s), visit www.raymarine.com/software.

4.11 Thermal camera connection

You can connect a thermal camera to your gS Series multifunction display.

The camera is usually connected via a Raymarine network switch. If you want to use the optional Joystick Control Unit (JCU) with the camera this must also be connected to the network switch. A composite video connection is required between the camera and the multifunction display.

T200 Series thermal camera direct connection

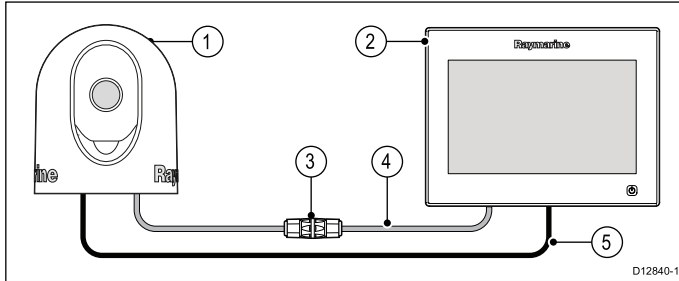

1. T200 Series fixed mount thermal camera.
2. Multifunction display.
3. Ethernet coupler.
4. RayNet to RJ45 SeaTalk^{hs} adaptor cable.
5. Video cable.

When connecting a T200 Series thermal camera to a gS Series multifunction display the camera can be supplied Power over Ethernet (PoE) by the display.

Refer to the [Power over Ethernet \(PoE\)](#) section for details on PoE assignment.

T300 / T400 Series thermal camera connection.

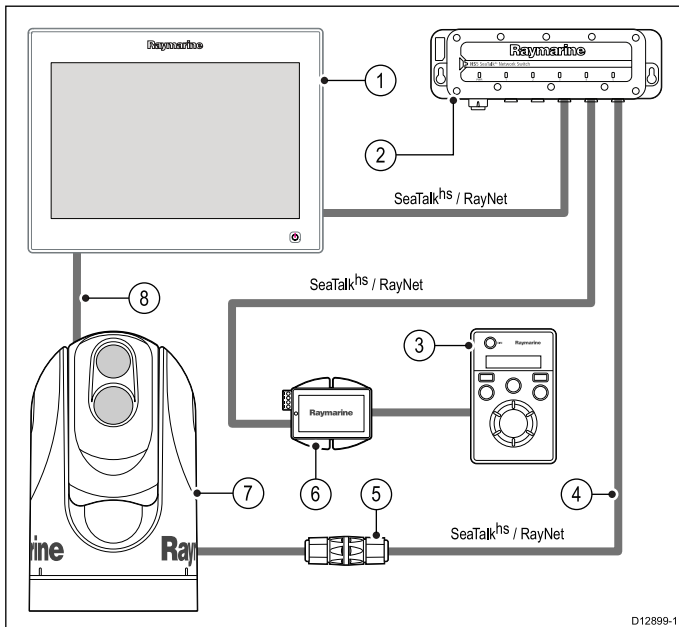

1. Multifunction display.
2. Network switch.
3. Joystick Control Unit (JCU) (optional).
4. RJ45 SeaTalk^{hs} to RayNet cable.
5. Ethernet coupler.
6. PoE injector (only required if using the optional JCU).
7. Thermal camera.
8. Video cable.

7. Thermal camera.

8. Video cable.

Important notes

- You can control the thermal camera using your multifunctional display. The Joystick Control Unit (JCU) is optional, but can be used in conjunction with the multifunctional display to control the thermal camera if required.
- “Dual payload” thermal cameras include 2 independent lenses; 1 for thermal (infrared) and 1 for visible light. If you only have 1 display you should only connect the video cable labelled “VIS / IR” (visible light / infrared) to the display. If you have 2 or more displays you should connect 1 cable to each display.
- You can only view the thermal camera image on the multifunction display to which the camera is physically connected. If you want to view the thermal camera image on more than 1 display you must obtain a suitable third-party video distribution unit.
- For further information regarding the camera's installation (including connections and mounting), refer to the installation instructions that accompany the camera.

Thermal camera cables

Cabling requirements for thermal cameras.

Camera to network switch

A network patch cable is required to connect the camera to the network switch. The connection is made between the camera cable tail and the network switch via the coupler (supplied with the camera). Network patch cables are available in a variety of lengths.

Joystick Control Unit (JCU)

An Ethernet (with power) cable is used to connect the JCU. The JCU is supplied with a 7.62 m (25 ft) Ethernet cable for this connection. If you require a different length contact your dealer for suitable cables.

Power over Ethernet (PoE) injector to network switch

A network patch cable is required for connecting the PoE injector to the network switch. Network patch cables are available in a variety of lengths.

Video cables

Video cables are not supplied with the product. Please contact your dealer for suitable cables and adaptors.

Raymarine recommends the use of a BNC terminated RG59 75ohm (or better) coaxial cable.

4.12 IP Camera connections

You can connect IP cameras to your multifunction display.

Note: Compatible IP cameras must be able to be configured to:

- automatically assign an IP address via DHCP prior to connecting to your multifunction display or network.
- allow unauthenticated, anonymous ONVIF access.

Please refer to the instructions supplied with your IP camera for configuration details.

Note: Your multifunction display must be powered up before power is applied to any networked IP cameras, this is to enable your multifunction display to assign the IP camera(s) a valid IP address.

IP camera(s) can be connected directly to a network connector on your multifunction display.

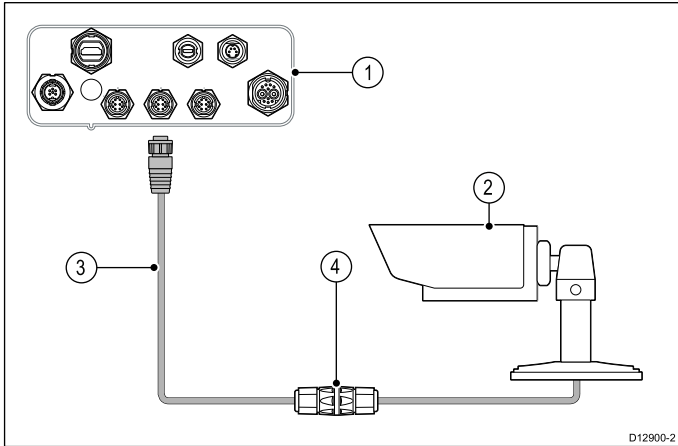

Item	Description
1	Multifunction display rear connector panel
2	CAM200IP
3	RayNet to RJ45 adaptor cable (A62360 / A80151 / A80159)
4	Ethernet coupler (R32142)

Note:

The gS Series multifunction displays can provide Power over Ethernet (PoE) to compatible IP cameras.

Refer to the [Power over Ethernet \(PoE\)](#) section for details on PoE assignment.

You can also connect multiple IP cameras via the SeaTalk^{hs} network

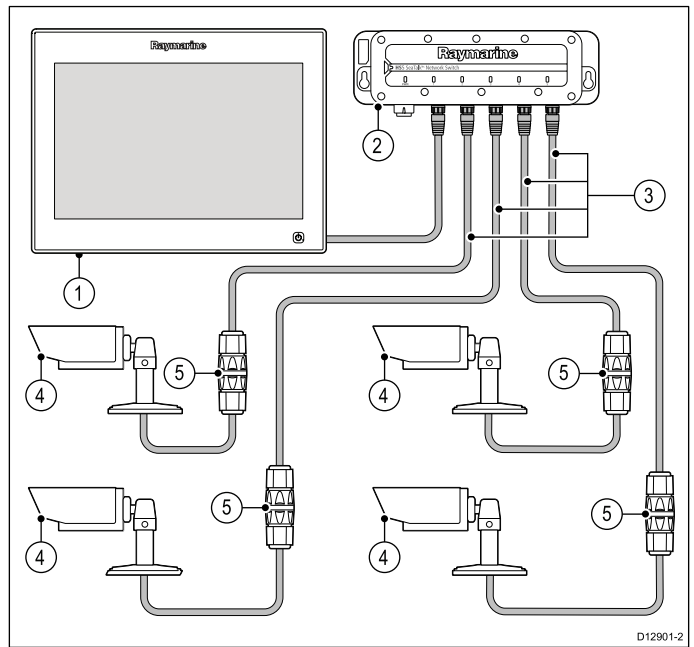

Item	Description
1	Multifunction display
2	Network switch
3	RayNet to RJ45 adaptor cables (A62360 / A80151 / A80159)
4	CAM200IPs
5	Ethernet couplers (R32142)

Note: Network switches do not provide PoE, connected cameras must have their own power supply.

Tip If your IP camera(s) are not detected by your multifunction display, try power cycling the IP camera(s) whilst leaving your multifunction display powered up.

IP camera guidance

Raymarine® MFDs are capable of displaying IP camera feeds. Whilst third-party IP cameras may work, **Raymarine®** highly recommends only using **Raymarine®** IP cameras such as the **CAM200IP**.

As guidance any third-party IP camera must conform to the following:

- The camera must support H.264 compression and RTSP (Real time Streaming Protocol).
- The camera must be ONVIF compliant
- The camera must be capable of and be setup to allow unauthenticated anonymous access
- The camera must be capable of and be setup to assign an IP address automatically via DHCP
- The camera resolution must be set to no higher than 720p

The camera settings must be checked and if necessary adjusted using a PC and the software supplied with the camera, prior to adding the camera to the **SeaTalk^{hs}** network.

Important: **Raymarine®** does not guarantee compatibility with third-party IP cameras.

4.13 Weather receiver connection

You can connect a Sirius XM weather receiver to your multifunction display.

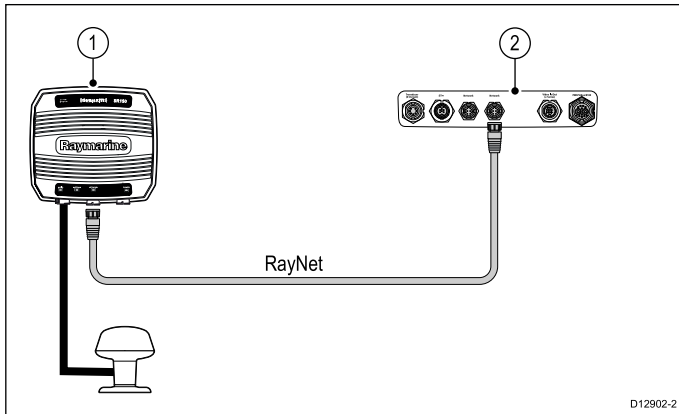

1. Raymarine weather receiver.
2. Multifunction display.

The weather receiver can also be connected to a Raymarine network switch.

For information on connecting an SR50 using SeaTalk^{ng} please refer to 82257 – SR50 operation which can be downloaded from the Raymarine website: www.raymarine.com.

4.14 Fusion link connection

You can connect a Fusion 700 series marine entertainment system to your multifunction display.

Direct connection

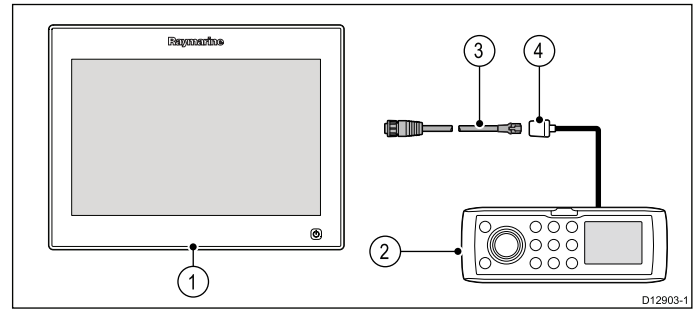

1. Multifunction display.
2. Fusion system.
3. RayNet to SeaTalk^{hs} adaptor cable.
4. Fusion ethernet connector.

Direct connection with networked multifunction displays

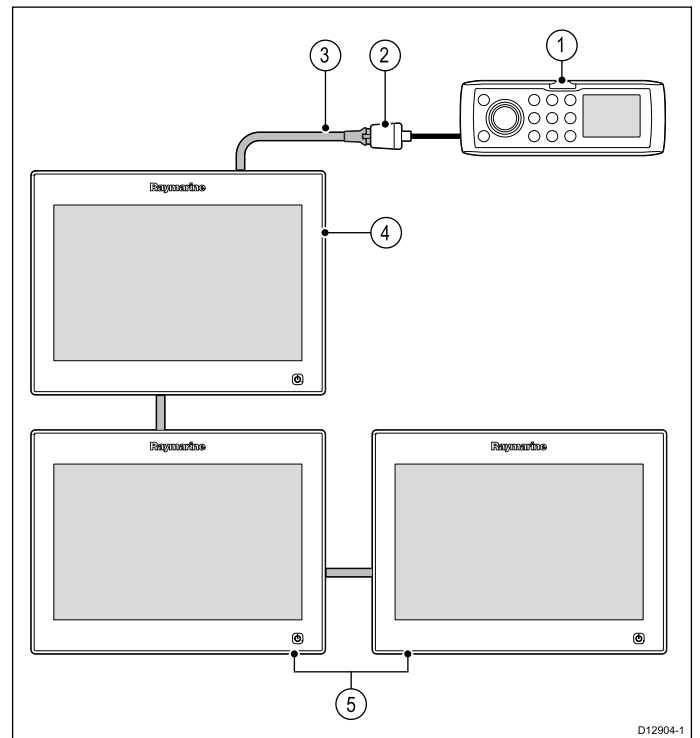

1. Fusion system.
2. Fusion ethernet connector.
3. RayNet to SeaTalk^{hs} adaptor cable.
4. Directly connected multifunction display.
5. Networked multifunction displays.

Note: The Fusion entertainment system can be controlled by a directly connected multifunction display or by a networked multifunction display.

Network connection

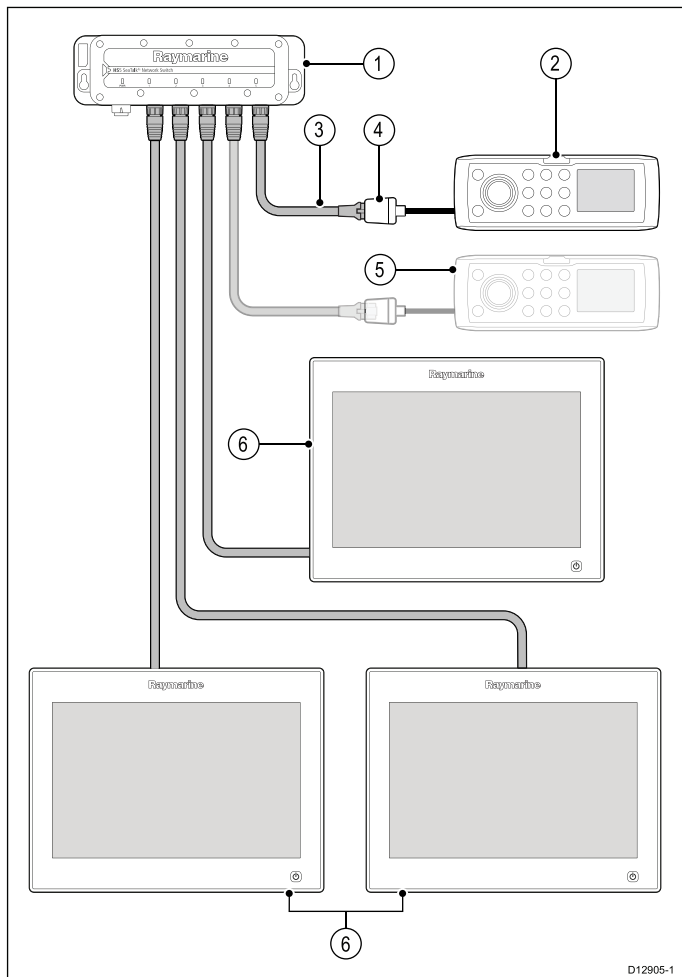

1. Network switch.
2. Fusion system.
3. RayNet to SeaTalk^{hs} adaptor cable.
4. Fusion ethernet connector.
5. Second Fusion system (the multifunction display can be connected to multiple Fusion entertainment systems).
6. Networked multifunction displays.

Note: The Fusion entertainment system can be controlled by any compatible networked multifunction display when connected using a network switch.

4.15 GPS connection

The multifunction display can be connected to a GPS receiver, using SeaTalk^{ng} or NMEA 0183.

GPS connection — SeaTalk^{ng}

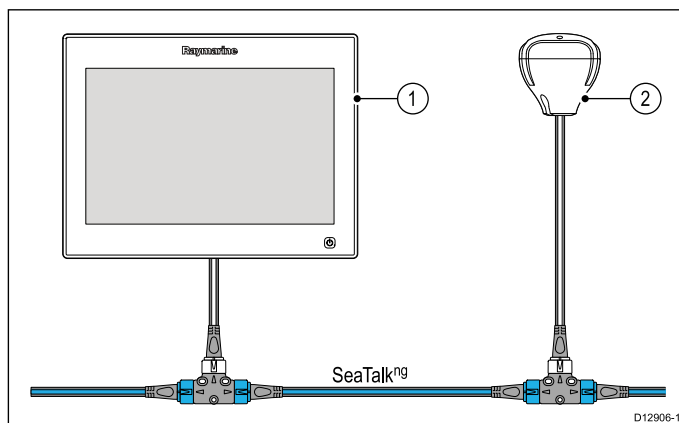

1. Multifunction display.
2. SeaTalk^{ng} GPS receiver.

GPS connection — NMEA 0183

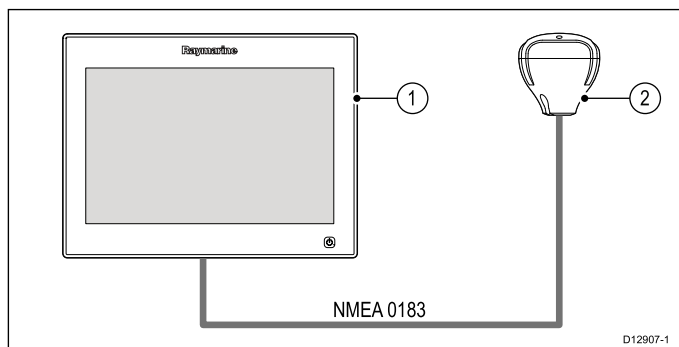

1. Multifunction display.
2. NMEA 0183 GPS receiver.

4.16 AIS connection

A compatible AIS can be connected using SeaTalk^{ng} or NMEA 0183.

Connection using SeaTalk^{ng}

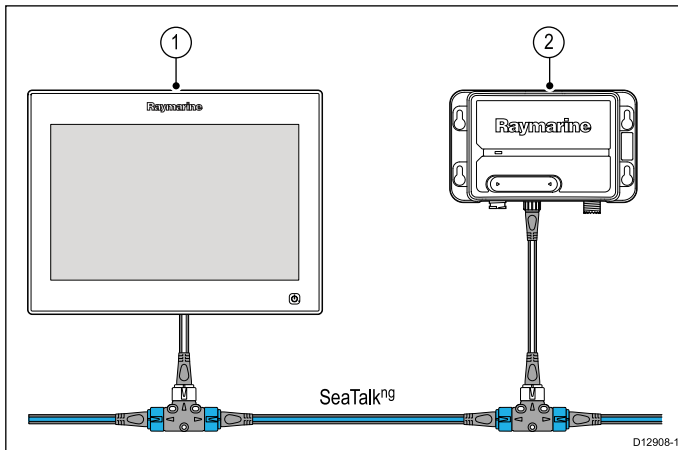

1. Multifunction display.
2. SeaTalk^{ng} AIS receiver / transceiver.

Connection using NMEA 0183

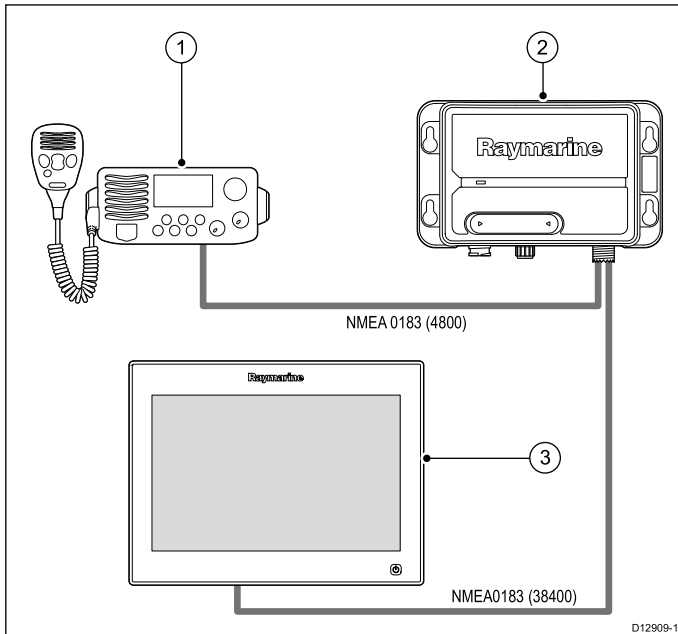

1. VHF radio.
2. AIS unit.
3. Multifunction display.

4.17 Fastheading connection

If you wish to use MARPA (radar target acquisition) functions on your multifunction display you need either:

- An autopilot connected to the multifunction display via SeaTalk^{ng} or NMEA 0183. The compass is connected to the course computer and calibrated via the pilot control head; or:
- A Raymarine or third-party fastheading sensor connected to the multifunction display via NMEA 0183.

Note: Please contact your dealer or Raymarine technical support for more information.

4.18 SeaTalk^{ng} connections

The display can connect to a SeaTalk^{ng} network.

The display can use SeaTalk^{ng} to communicate with:

- SeaTalk^{ng} instruments (for example, i70).
- SeaTalk^{ng} pilot control head (for example, p70).
- SeaTalk^{ng} autopilots (for example, Evolution autopilots or SmartPilot SPX course computer).
- SeaTalk equipment via the optional SeaTalk to SeaTalk^{ng} converter.
- NMEA 2000 equipment via optional DeviceNet adaptor cables.

Typical SeaTalk^{ng} system

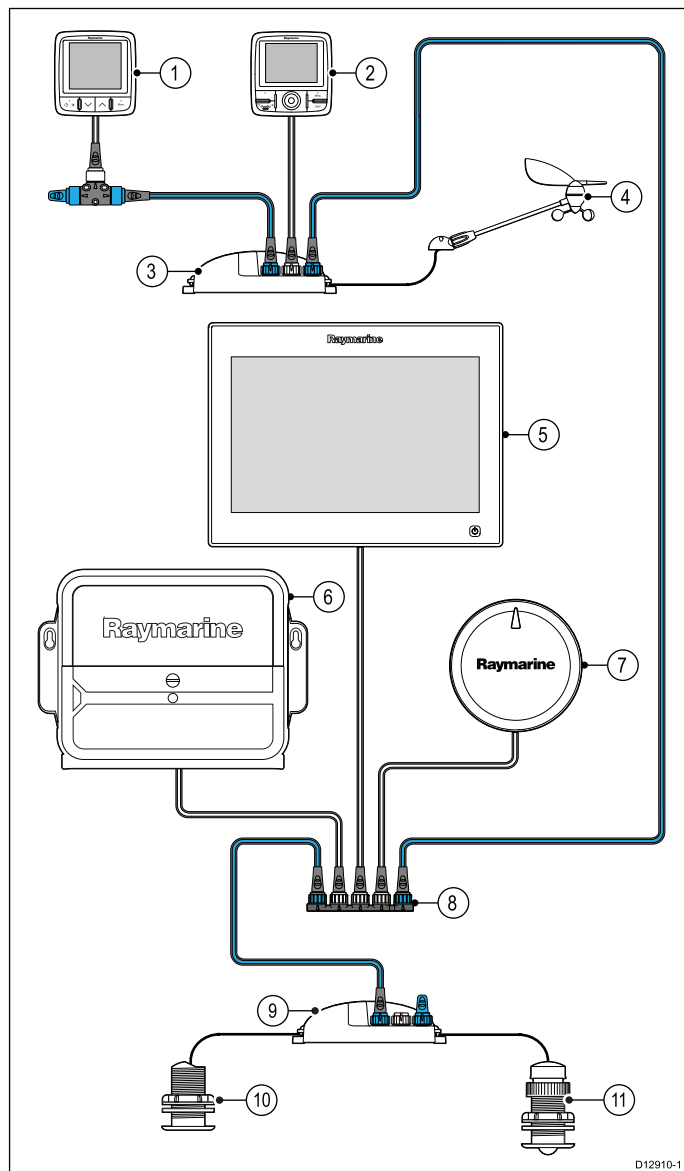

1. SeaTalk^{ng} instrument — for example, i70.
2. SeaTalk^{ng} pilot control head — for example, p70.
3. iTC-5 converter.
4. Wind transducer.
5. Multifunction display.
6. Actuator Control Unit (ACU).
7. EV unit.
8. SeaTalk^{ng} 5 Way block.

9. iTC-5 converter.
10. Depth transducer.
11. Speed transducer.

SeaTalk^{ng} power requirements

The SeaTalk^{ng} bus requires a 12 V power supply.

Power may be provided from:

- Raymarine equipment with a regulated 12 V power supply (for example, a SmartPilot SPX course computer); or:
- Other suitable 12 V power supply.

Note: SeaTalk^{ng} does NOT supply power to multifunction displays and other equipment with a dedicated power supply input.

4.19 NMEA 2000 connection

The display can receive data from NMEA 2000 devices (e.g. data from compatible engines). The NMEA 2000 connection is made using SeaTalk^{ng} and appropriate adaptor cables.

You can EITHER:

- Use your SeaTalk^{ng} backbone and connect each NMEA 2000 device on a spur, OR
- connect the display on a spur into an existing NMEA 2000 backbone.

Important: You cannot have 2 backbones connected together.

Connecting NMEA 2000 equipment to the SeaTalk^{ng} backbone

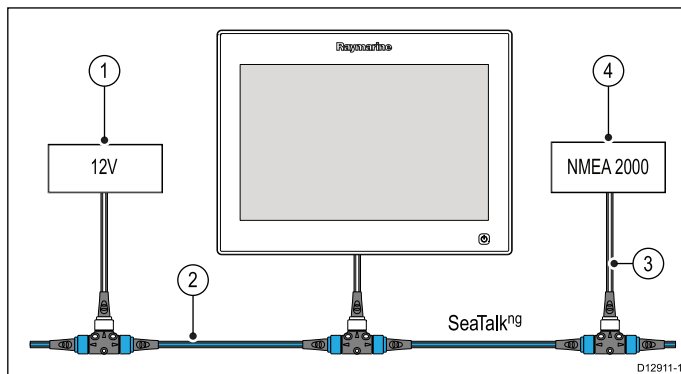

1. 12 V supply into backbone.
2. SeaTalk^{ng} backbone.
3. SeaTalk^{ng} to DeviceNet adaptor cable.
4. NMEA 2000 equipment.

Connecting the display to an existing NMEA 2000 (DeviceNet) backbone

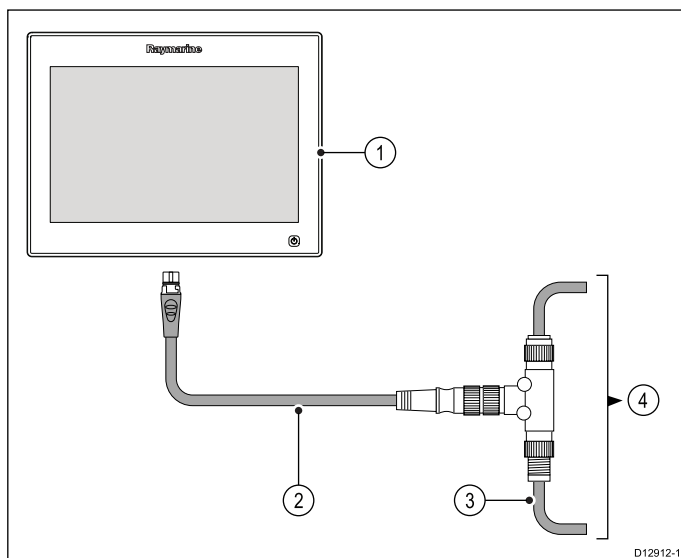

1. Multifunction display.
2. SeaTalk^{ng} to DeviceNet adaptor cable.
3. DeviceNet backbone.
4. NMEA 2000 equipment.

4.20 SeaTalk connection

You can connect SeaTalk devices to your multifunction display using the optional SeaTalk to SeaTalk^{ng} converter.

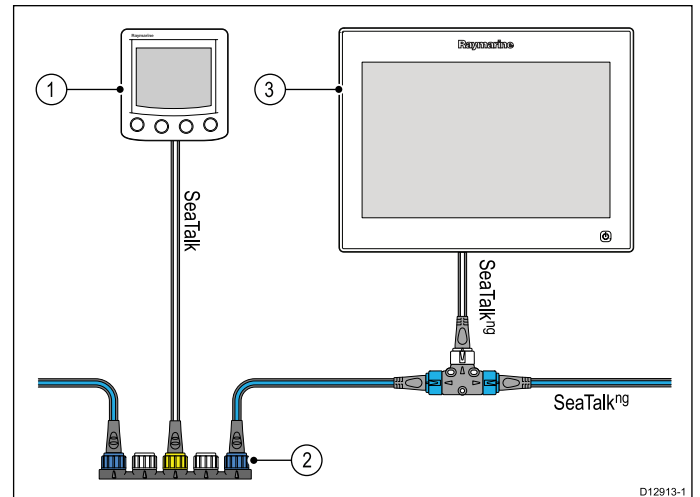

1. SeaTalk device.
2. SeaTalk to SeaTalk^{ng} converter.
3. Multifunction display.

4.21 NMEA 0183 connection

NMEA 0183 devices can be connected to the multifunction display using the power and data cable.

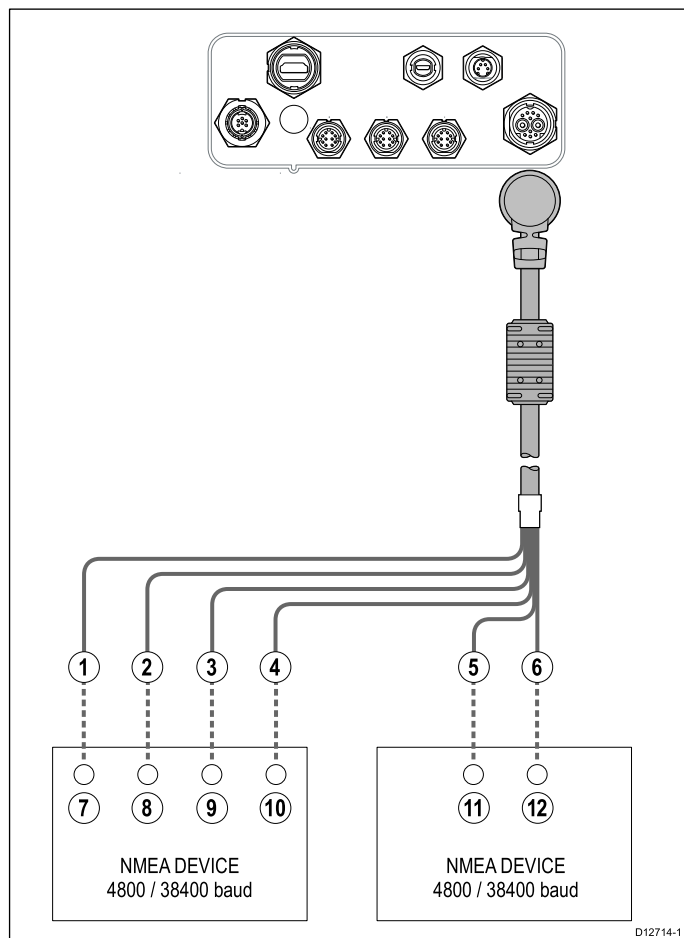

NMEA 0183 devices are connected using the supplied power and data cable.

The display has 2 NMEA 0183 ports:

- **Port 1:** Input and output, 4800 or 38400 baud rate.
- **Port 2:** Input only, 4800 or 38400 baud rate.

Note: The baud rate you want to use for each port input must be specified in the System Settings menu (**Homescreen: > Set-up > System Settings > NMEA Set-up > NMEA Input Port**).

Note: For Port 1, both the input and output communicate at the same baud rate. For example, if you have one NMEA 0183 device connected to the display's Port 1 INPUT, and another NMEA 0183 device connected to the display's Port 1 OUTPUT, both NMEA devices must be using the same baud rate.

You can connect up to 4 NMEA 0183 devices to the display's NMEA 0183 OUTPUT (Port 1). You can connect a total of 2 NMEA 0183 devices to the display's NMEA 0183 INPUT ports.

Item	Device	Cable color	Port	Input / output	Positive (+) / negative (-)
1	Multifunction display	White	1	Input	Positive
2		Green	1	Input	Negative
3		Yellow	1	Output	Positive
4		Brown	1	Output	Negative
5		Orange / white	2	Input	Positive
6		Orange / green	2	Input	Negative
7	NMEA device	*	*	Output	Positive
8		*	*	Output	Negative
9		*	*	Input	Positive
10		*	*	Input	Negative
11	NMEA device	*	*	Output	Positive
12		*	*	Output	Negative

Note: *Refer to instructions provided with the NMEA device.

NMEA 0183 cable

You can extend the NMEA 0183 wires within the supplied power and data cable.

Data cable extension

Total length (max)	Cable
Up to 5 m	High quality data cable: <ul style="list-style-type: none"> • 2 x twisted pair with overall shield. • 50 to 75 pF/m capacitance core to core.

4.22 Camera / Video connections

A camera or a video device can be connected directly your multifunction display using the video connector on the power and data cable or using the dedicated Video / alarm connector.

Examples of video sources that you can connect to the display include:

- Video camera.
- Thermal camera.
- DVD player.
- Portable digital video player.

Power / Data cable video input

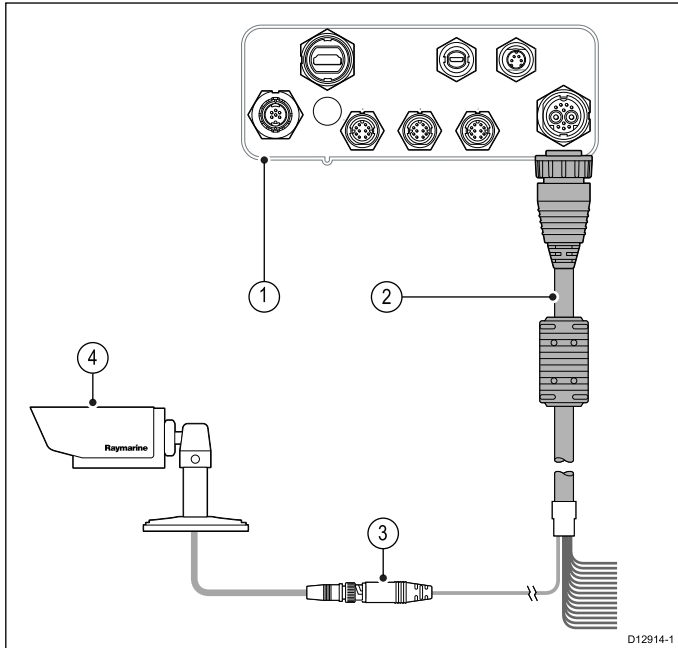

1. Multifunction display rear connector panel.
2. Power and data cable.
3. BNC video input connector .
4. Video source (e.g. video camera).

Video / alarm connector video input

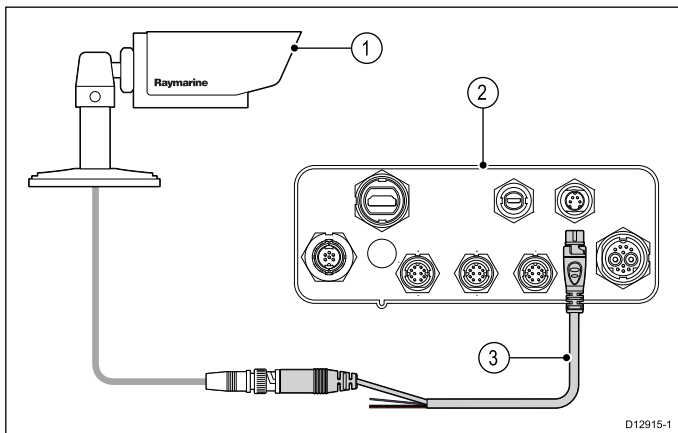

1. Video source (e.g. video camera).
2. Multifunction display rear connector panel.
3. Video / alarm cable (supplied).

Note: To listen to a movie's audio track, any connected DVD or digital video player will require speakers to be connected to the players audio output.

4.23 HDMI video output

The HDMI cable is used to output a gS multifunction display's screen to an external display.

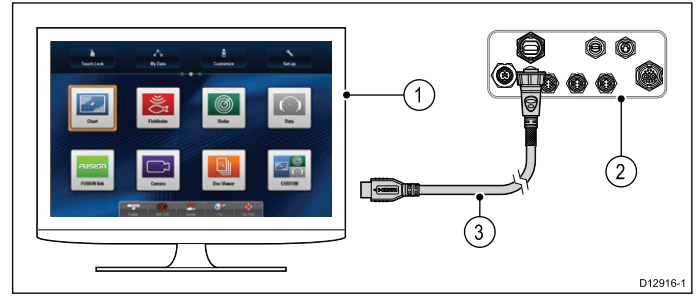

1. External display (See note below).
2. Multifunction display rear connector panel.
3. Raymarine 5 m (16.4 ft) HDMI video output cable (A80219)

Note:

1. The external display you are connecting to must support the 720p standard to enable you to view the multifunction display screen on the external display. The multifunction display's video output resolution is fixed at 720p.
2. The HDMI cable must only be connected to an external display that is electrically isolated from the vessel's dc power supply (i.e the screen and the 0V of the external display's HDMI connector must not have a direct connection to the vessel's dc power supply).

For further assistance please contact Raymarine technical support.

4.24 HD-SDI connection (gS195)

The gS195 includes a High Definition Serial Digital Interface (HD-SDI), which can be used to view a compatible video source using the multifunction display's Camera application.

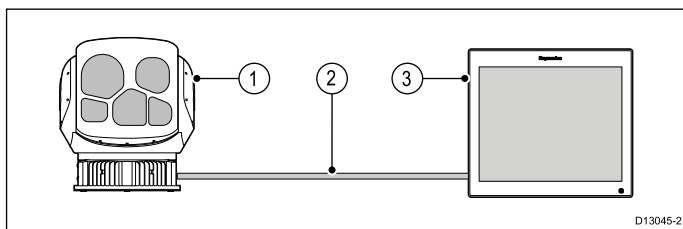

1. HD-SDI camera
2. HD-SDI input data cable
3. gS195 multifunction display

Note: If your camera or external display do not have a standard BNC connection then a third party adaptor and / or converter may be required.

The HD-SDI interface connections use BNC connectors. It is recommended that Belden 1694A cable (not supplied) and the supplied BNC connectors should be used to create the data cables required for connecting the camera to the multifunction display.

HD-SDI camera connection

The supplied BNC connectors and boot kit should be used when connecting a camera using the units HD-SDI interface.

When making the data cables the cable should be fed through the boot first before attaching the BNC connector to the end of the cable. It may be possible to push the boot over the BNC connector and onto the cable, however care must be taken not to split the protective boot.

HD-SDI connection

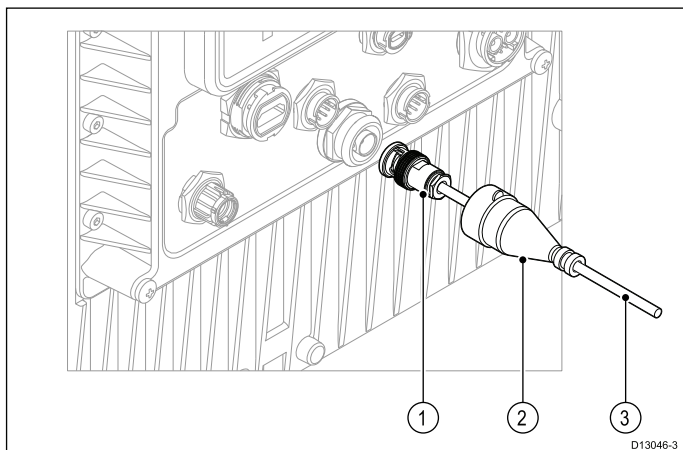

1. 75 ohm BNC connector (Supplied)
2. Boot (Supplied)
3. Data cable (not supplied)

Connecting the data cable(s)

Follow the steps below to connect your HD-SDI data cable(s) to the multifunction display.

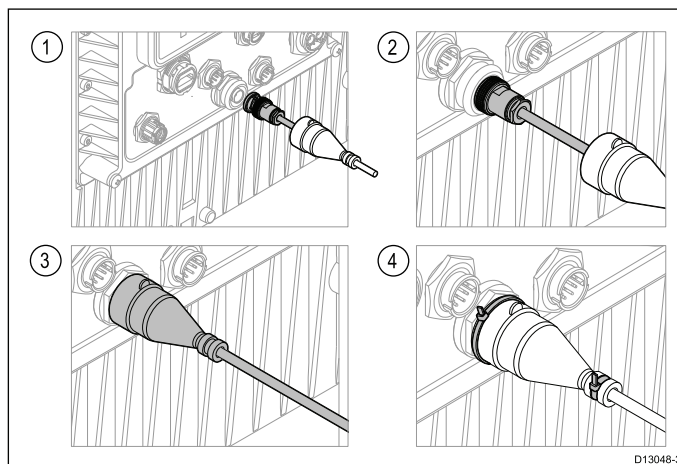

1. Ensure the BNC connector is correctly orientated.
2. Fully insert the BNC connector into the relevant HD-SDI connection on the back of your multifunction display and turn the locking collar clockwise until locked into position.
3. Push the protective boot over the BNC connector and HD-SDI connection on the back of the display.
4. Use 2 cable ties (supplied) to secure the protective boot over the connection.

Protecting disconnected cables

If a BNC cable is to be left disconnected then the protective cap should be secured to the end of the boot.

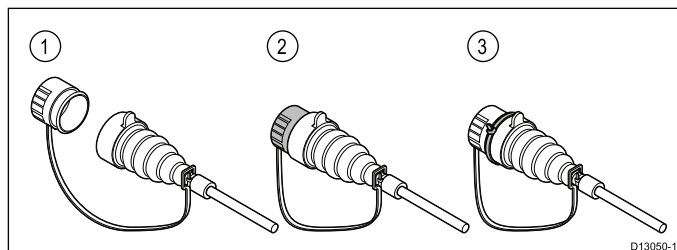

1. Disconnected the BNC cable from the multifunction display.
2. Push the boot over the cap as shown below.
3. It is recommended that a cable tie be used to secure the boot to the cap.

HD-SDI maximum cable length

The maximum recommended cable length is shown below.

HD-SDI input cable	50 m (164 ft.)
--------------------	----------------

4.25 Media player connection

You can use your multifunction display to wirelessly control a Bluetooth-compatible media player (such as a smartphone).

The media player must be compatible with the Bluetooth AVRCP protocol (version 2.1 or higher).

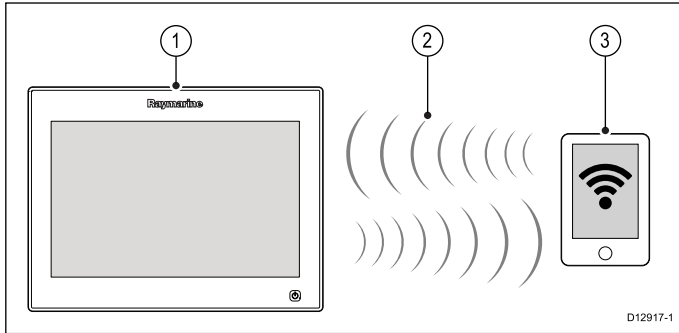

1. Multifunction display.
2. Bluetooth connection.
3. Bluetooth-compatible media player.

To use this feature you must first:

- Enable Bluetooth in the System Settings on the multifunction display.
- Enable Bluetooth on the media player device.
- Pair the media player device with the multifunction display.
- Enable Audio Control in the System Settings on the multifunction display.

You can also connect an RCU-3 remote and assign the shortcut key to Start/Stop audio playback

Note: If your media player does not include built-in speakers it may be necessary to connect the media player's audio output to an external audio system or a pair of headphones. For more information refer to the instructions that accompany the media player device.

Enabling Bluetooth

With the homescreen displayed:

1. Select **Set-up**.
2. Select **System Settings**.
3. Select **Wireless Connections**.
4. Select **Bluetooth > On**.

Pairing a Bluetooth media player

With the homescreen displayed and Bluetooth turned on:

1. Select **Set-up**.
2. Select **System Settings**.
3. Select **Wireless Connections**.
4. Select **New Bluetooth Connection**.
A message is displayed prompting you to put your media player device into discovery mode.
5. Ensure Bluetooth is enabled on your external media player device and ensure it is ready to be paired. For more information, consult the instructions that accompany the device.

6. On the multifunction display, select **OK** in the message dialog.
The multifunction display will search for active Bluetooth devices.
7. Select **Stop Discovery** when your device appears in the list.
8. Select the media player device in the list.
A pairing request message is displayed on the external media device.
9. On the external media device, select **Pair** (or equivalent) to accept the pairing request message.
The multifunction display shows a message asking you to confirm the Pairing code.
10. If the pairing code displayed on the multifunction display matches the code displayed on the external media device, select **Ok** on the multifunction display. If the code does NOT match, repeat steps 4 to 8.
11. If the pairing was successful the multifunction display will confirm the pairing.
The external media device is now paired with the multifunction display.

Enabling audio control

With the homescreen displayed:

1. Select **Set-up**.
2. Select **System Settings**.
3. Select **Wireless Connections**.
4. Select **Connection Manager**.
5. Select the media player device in the list.
6. Select **Audio Control > On**.



Media player controls

Touchscreen multifunction displays enable you to use the on-screen media player controls to control the audio playing on your external media player.



1. Touch this icon to display the audio controls.
2. Previous track.
3. Play track.
4. Pause track.
5. Next track.

Selecting **Back** will hide the audio controls.

Media player controls using a remote control

You can control audio wirelessly using a Raymarine RCU-3 remote control unit.

The Shortcut key on the RCU-3 must be set to Start/Stop audio playback, refer to the *Using a Remote control* section for further details.

1. Press **UP** arrow for next track.
2. Press **DOWN** arrow for previous track.
3. Press **SHORTCUT** button to play/pause audio.

Unpairing a Bluetooth device

If you are experiencing problems when attempting to use a Bluetooth device with the multifunction display it may be necessary to unpair the device (and any other paired Bluetooth devices) and then retry the pairing procedure.

With the homescreen displayed:

1. Select **Set-up**.
2. Select **System Settings**.
3. Select **Wireless Connections**.
4. Select **Connection Manager**.
5. Select the media player device in the list.
6. Select **Unpair / Forget this device**.

4.26 Bluetooth remote control connection

You can control the multifunction display wirelessly using a Raymarine remote control unit.

The remote control uses a Bluetooth wireless connection.

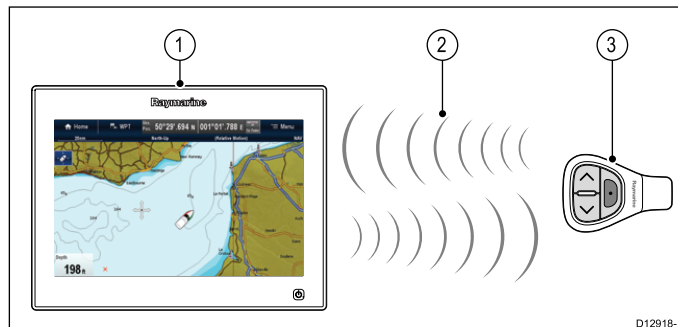

1. Multifunction display.
2. Bluetooth connection.
3. Raymarine Bluetooth remote control (for example, RCU-3).

To use the remote control you must first:

- Enable Bluetooth in the System Settings on the multifunction display.
- Pair the remote control unit with the multifunction display.

Operating principles

Remote control operating principles.

- Only 1 multifunction display may be operated by a remote control unit at any one time. You cannot pair a multifunction display to more than 1 remote control at the same time.
- The 3 buttons on the remote control unit have different functions depending on the CONTEXT in which you are using it. For example, in the chart application the buttons control different functions than they do in the homescreen.
- All functions are accessed using a combination of the 3 buttons. For some functions you must press a button **MOMENTARILY**. You can also **HOLD** a button for continuous response (for example, continuous ranging in the chart application).
- The main methods of operation involve the use of the **UP** and **DOWN** “arrow” buttons to highlight different on-screen options. The **SHORTCUT** button is used to select (execute) them.
- During the pairing process you must define which of the arrow buttons you want to be the “UP” button.
- The **SHORTCUT** button is customizable and can be configured to operate one of a number of functions, using the System Settings menu on your multifunction display.

Pairing the remote and configuring the UP and DOWN buttons

The remote control unit must be “paired” with the multifunction display that you want to control. On

your multifunction display, with the homescreen displayed:

1. Select **Set-up**.
2. Select **System Settings**.
3. Select **Wireless Connections**.
4. Select **Bluetooth > On**.
5. Select **New Bluetooth Connection**.
A pop-up message will be displayed to confirm that the device you are connecting to is discoverable.
6. Select **Ok** to confirm.
A list of discovered devices is displayed.
7. On your **remote control unit**, hold down the UP and DOWN buttons together for 10 seconds.
8. Select the remote control unit in the list of devices.
9. When prompted, press the arrow button on your remote that you wish to be configured as the UP button. The other arrow button will automatically be configured as the DOWN button.
If the pairing was successful a "Pairing Success" message will be displayed. If a "Pairing Failure" or "Pairing Timeout" message is displayed, repeat steps 1 to 8.

Customizing the SHORTCUT button

On your multifunction display, with the homescreen displayed:

1. Select **Set-up**.
2. Select **System Settings**.
3. Select **External Devices**.
4. Select **Remote Control**.
5. Select **Customize shortcut key**.
6. Select the function that you want to assign to the **SHORTCUT** key.

4.27 Remote control functions

Buttons

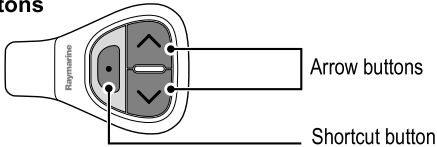

Range



Pair



Select

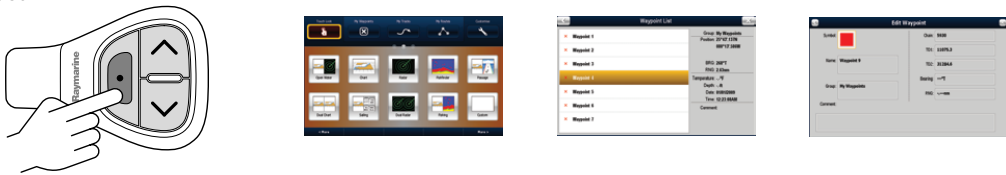

D12051-2

	Button	Application where function available:				
		Chart	Radar	Fishfinder	Weather	Home-screen
Default functions:						
Range / zoom.	<ul style="list-style-type: none"> Press UP or DOWN arrow for momentary response. Hold UP or DOWN arrow for continuous response. 	✓	✓	✓	✓	✗
Open homescreen.	Shortcut: Hold	✓	✓	✓	✓	✗
Select application in homescreen (in left-to-right, top-to-bottom order).	<ul style="list-style-type: none"> Press UP or DOWN arrow for momentary response. Hold UP or DOWN arrow for continuous response. 	✗	✗	✗	✗	✓
Toggle menu items and options in dialogs and prompts (in left-to-right, top-to-bottom order).	<ul style="list-style-type: none"> Press UP or DOWN arrow for momentary response. Hold UP or DOWN arrow for continuous response. 	✓	✓	✓	✓	✓
Place waypoint at vessel position.	Shortcut	✓	✓	✓	✓	✗
Media player control (requires a Bluetooth media player paired to the multifunction display).	<ul style="list-style-type: none"> Press UP / DOWN arrow for next / previous track. Press SHORTCUT button for play / pause. 	✓	✓	✓	✓	✓

	Button	Application where function available:				
Customizable functions:						
Open homescreen.	SHORTCUT	✓	✓	✓	✓	✗
Switch active application (only available when multiple applications are displayed).	SHORTCUT	✓	✓	✓	✓	✗

Reconnecting the RCU

1. When you pair the RCU-3 with a multifunction display a wireless connection is established.

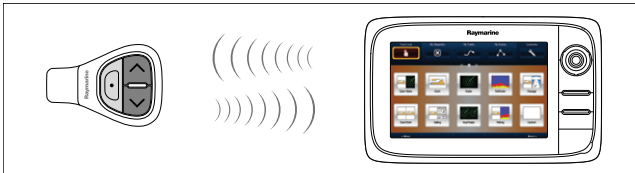

2. When you power off the multifunction display it loses its connection with the RCU-3 after 10 minutes.

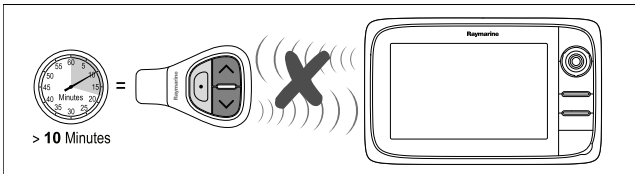

3. To restore the connection between the 2 units, press and hold any button on the RCU-3 for at least 3 seconds.

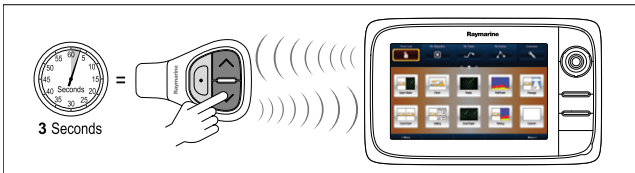

Note: You will also need to reconnect the RCU-3 as described above if you disable and then re-enable the Bluetooth connection on the multifunction display at any time.

4.28 WiFi connections

Raymarine mobile app connection

You can use compatible tablet and smartphone devices as a wireless repeat display or remote control for your multifunction display.

Raymarine apps allow you to stream and / or control, remotely what you see on your multifunction display to a compatible device, using a Wi-Fi connection.

To use this feature you must first:

- Ensure your device is compatible with the app you wish to use.
- Download and install the relevant Raymarine app, available from the relevant market store.
- Enable Wi-Fi in the System Settings on the multifunction display.
- Enable Wi-Fi on your compatible device.
- Select the Raymarine Wi-Fi connection from the list of available Wi-Fi networks on your compatible device.
- Enable the relevant Mobile app in the System Settings menu on the multifunction display.

Note: The multifunction display acts as a Wi-Fi access point. If your device already connects to an access point for e-mail and internet you must revert your access point back to regain access to e-mails and internet.

Navionics mobile marine app

You can wirelessly synchronize data between your multifunction display (MFD) and a mobile device that is running the Navionics mobile marine app.

The synchronization downloads Navionics Freshest Data from your mobile device to your MFD and uploads sonar logs from your MFD to your mobile device. Waypoints and routes can also be synchronized between your mobile device and MFD.

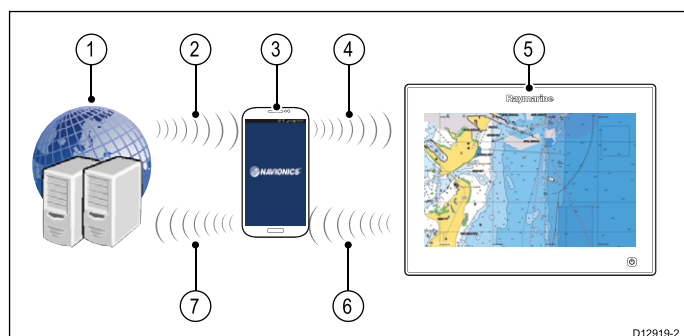

1	Navionics servers
2	Download Navionics Freshest Data to mobile device (internet connection required)
3	Mobile device running Navionics mobile app
4	Download Navionics Freshest Data to MFD (Wi-Fi connection to MFD required)
5	MFD

6	* Upload Sonar Logs and Community edits to mobile device (Wi-Fi connection to MFD required)
7	** Upload Sonar Logs and Community edits anonymously to Navionics servers (internet connection required)

Note:

* To participate in Navionics Sonar Charts, Sonar logging must be enabled on your MFD. Sonar Logs can be enabled from the Chart application menu: **Menu > Depth & Contour > Sonar Logs.**

** The Sonar logs shall be uploaded to Navionics servers anonymously.

To use this feature you must first:

1. Download and install the Navionics Mobile Marine app, available from the relevant app store.
2. Subscribe to Navionics Freshest Data.
3. Download Freshest data to your mobile device.
4. Enable Wi-Fi in the System Settings on the MFD.
5. Enable Wi-Fi on your mobile device.
6. Select the MFD Wi-Fi connection from the list of available Wi-Fi networks on your mobile device.

Chapter 5: Mounting

Chapter contents

- [5.1 Bracket mounting hole locations on page 76](#)
- [5.2 Mounting surface requirements on page 76](#)
- [5.3 Flush mounting the display on page 77](#)
- [5.4 Flush mounting the card reader on page 78](#)
- [5.5 Surface mounting the display on page 79](#)
- [5.6 Surface mounting the card reader on page 80](#)

5.1 Bracket mounting hole locations

The location of the bracket mounting holes on each display variant is shown below.

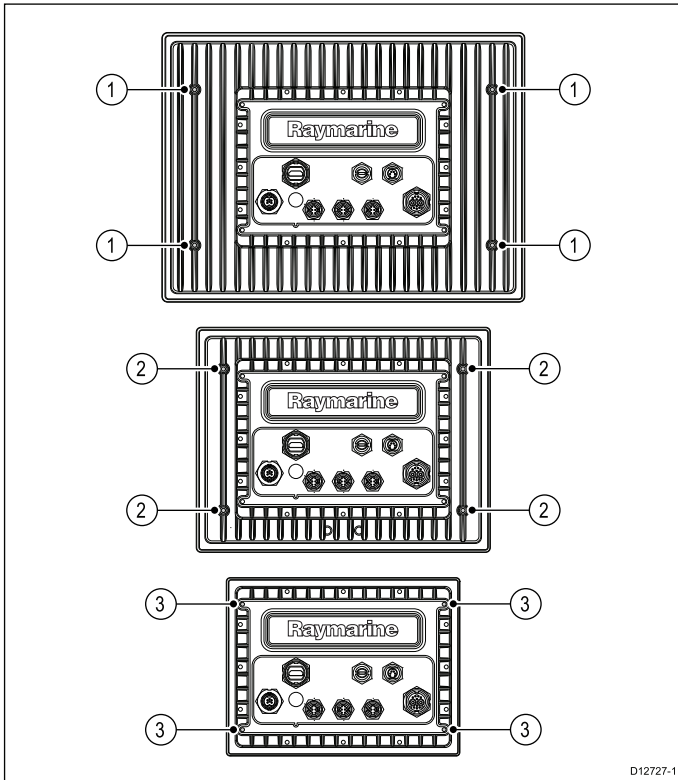

1	gS165 and gS195 bracket mounting hole locations
2	gS125 bracket mounting hole locations
3	gS95 bracket mounting hole locations

5.2 Mounting surface requirements

Short desc is not printed, but is used in searches

This product is heavy. To prevent potential damage to the product and / or your vessel, observe the following BEFORE installing the product:

- Refer to the weight information provided in the technical specification for this product and ensure that the intended mounting surface is suitable for bearing the weight.
- If the mounting surface is not suitable for the product weight, you may need to reinforce the mounting surface.
- If in doubt, refer to a professional marine equipment installer for further guidance.

5.3 Flush mounting the display

For flush mounting you must rebate the mounting surface.

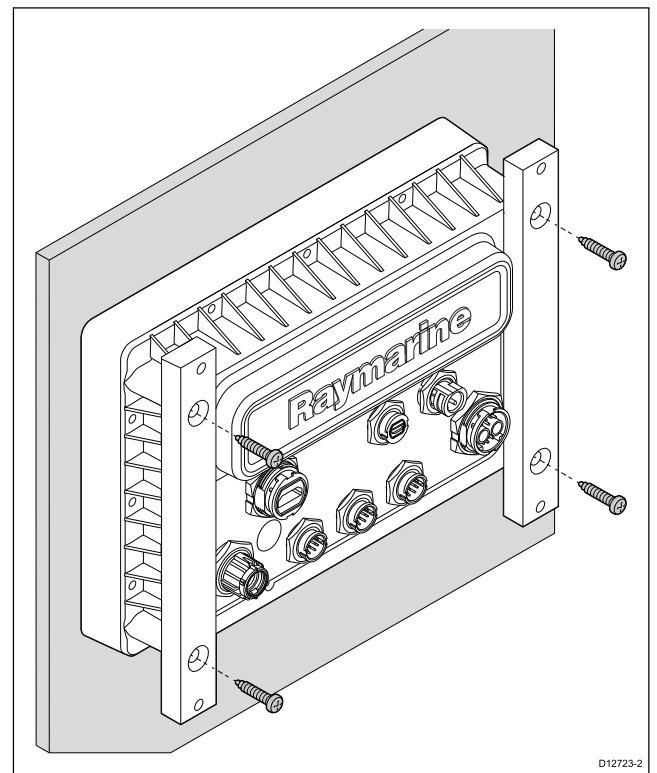
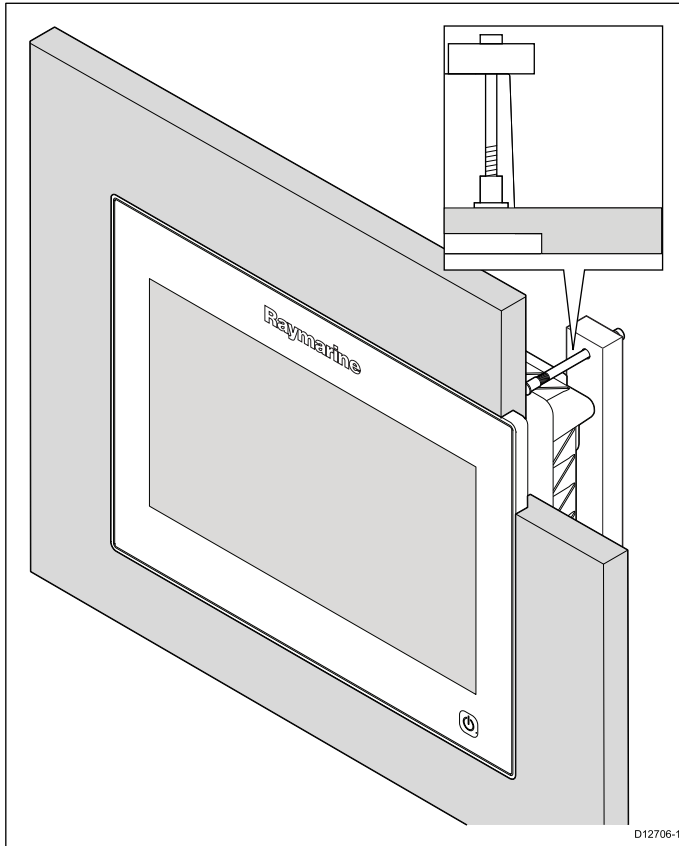

Note: Refer to the [5.1 Bracket mounting hole locations](#) section for details of the location of the bracket mounting holes on the rear of your display.

1. Check the selected location for the unit. A clear, flat area with suitable clearance behind the panel is required.
2. Before modifying the mounting surface, refer to the dimensions supplied in this document to ensure there is enough space for the display and all cables.
3. Fix the supplied mounting template to the selected location, using masking or self-adhesive tape.
4. Using a suitable hole saw (the size and position is indicated on the template), make a hole in each corner of the cut-out area.
5. Using a suitable saw, cut along the inside edge of the rear casing cut-out line indicated on the template.
6. Follow the rebate cut-out line on the template to cut a rebate around the hole with a depth of 8.5 mm (0.33 in), to accept the display.
7. Ensure that the unit fits into the removed area and then remove any rough edges.
8. Affix the supplied gasket onto the rear of the display and press firmly onto the flange.
9. Connect the power, data and other cables to the unit.
10. Attach the supplied mounting brackets to the rear of the display using the supplied fixings, as shown in the diagram below. Use one bracket for each side of the display.

11. Secure the display using the provided mounting fixings (bolt, washer, lock nut and foot. In 4 locations.

Depending on the thickness of the mounting surface the washer and lock nut may be located:

1. between the mounting bracket and mounting feet (as shown in (1) and (2) below, or
2. after the mounting bracket as shown in (3) and (4) below.

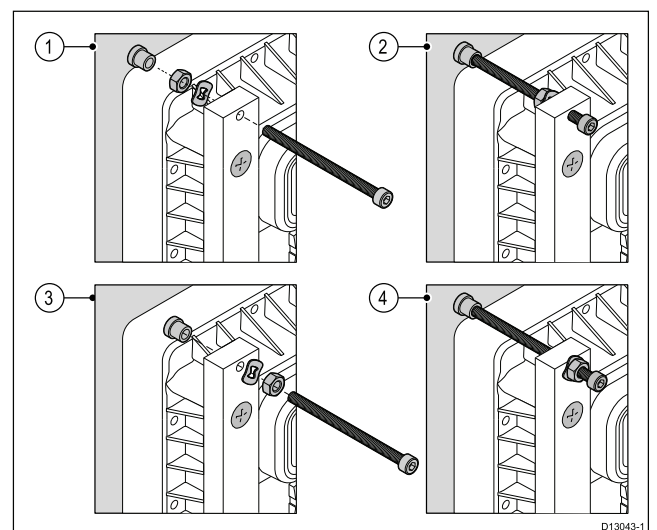

12. Using a suitable allen key, tighten the bracket mounting bolts so that the feet are tight against the rear of the mounting surface.

- Using a suitable sized wrench tighten the lock nut against the washer and the mounting bracket to lock in position.

The lock nut should be tightened sufficiently to securely hold the display in position. Do not overtighten.

Note: The supplied gasket provides a seal between the unit and a suitably flat and stiff mounting surface or binnacle. The gasket should be used in all installations. It may also be necessary to use a marine-grade sealant if the mounting surface or binnacle is not entirely flat and stiff or has a rough surface finish.

5.4 Flush mounting the card reader

For flush mounting you must rebate the mounting surface to accommodate chart reader housing.

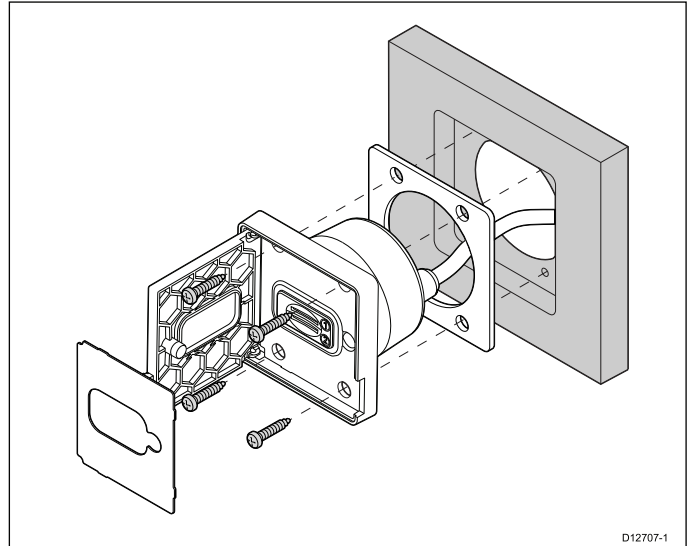

- Check the selected location for the unit. A clear, flat area with suitable clearance behind the panel is required.
- Before modifying the mounting surface, refer to the dimensions supplied in this document to ensure there is enough space for the unit and cable.
- Fix the supplied mounting template to the selected location, using masking or self-adhesive tape.
- Drill 4 holes as indicated on the mounting template to accept the fixings.
- Using a 40 mm (1.6 in) hole cutter, drill out the cut-out area identified on the mounting template.
- Follow the rebate cut-out line on the template to cut a rebate around the hole with a depth of 8.5 mm (0.33 in), to accept the unit.
- Ensure that the card reader fits into the removed area and then remove rough edges.
- Affix the supplied gasket onto the rear of the card reader and press firmly onto the flange.
- Feed the cable through the hole and connect to the multifunction display's card reader connector.
- Place the card reader into the rebate and secure using the fixings provided.
- Insert the card reader label over the top of the card reader slots so that the mounting screw locations are covered.

Note: The appropriate tightening torque and drill bit size to use depends on the thickness of the mounting surface and the type of material it is made from.

Note: The supplied gasket provides a seal between the unit and a suitably flat and stiff mounting surface or binnacle. The gasket should be used in all installations. It may also be necessary to use a marine-grade sealant if the mounting surface or binnacle is not entirely flat and stiff or has a rough surface finish.

5.5 Surface mounting the display

1. Check the selected location for the unit. A clear, flat area with suitable clearance behind the panel is required.
2. Before modifying the mounting surface, refer to the dimensions supplied in this document to ensure there is enough space for the display and all cables.
3. Fix the supplied mounting template to the selected location, using masking or self-adhesive tape.
4. Using a suitable hole saw (the size and position is indicated on the template), make a hole in each corner of the cut-out area.
5. Using a suitable saw, cut along the inside edge of the rear casing cut-out line indicated on the template.
6. Ensure that the unit fits into the removed area and then remove any rough edges.

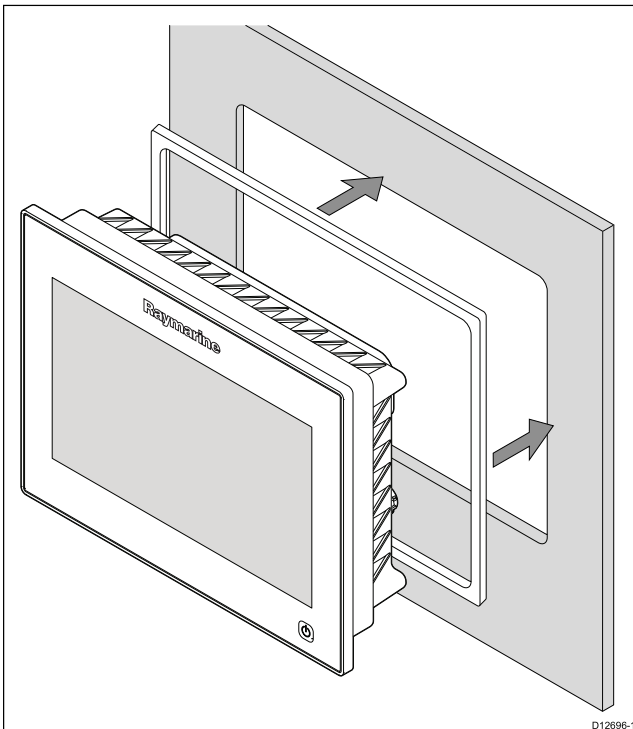

7. Affix the supplied gasket onto the rear of the display and press firmly onto the flange.
8. Connect the power, data and other cables to the unit.
9. Attach the supplied mounting brackets to the rear of the display using the supplied fixings, as shown in the diagram below. Use one bracket for each side of the display.

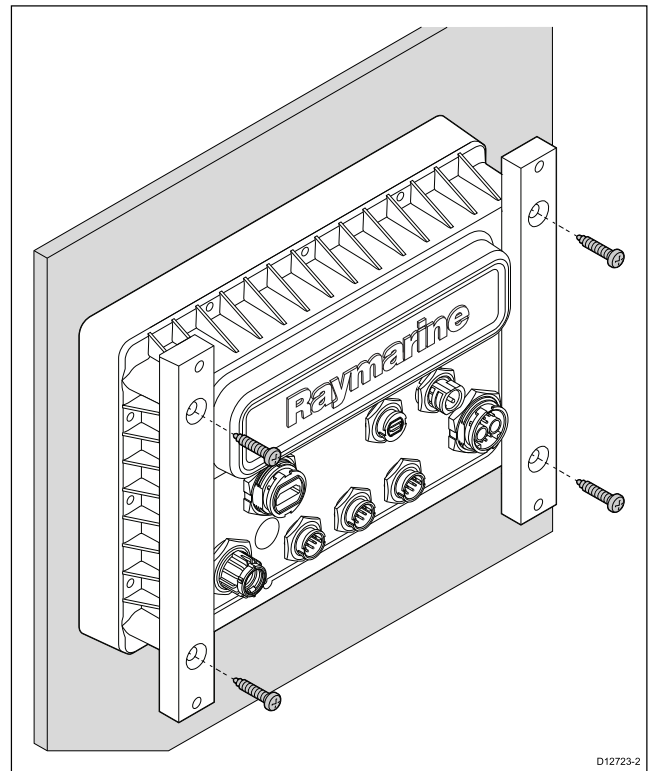

Note: Refer to the [5.1 Bracket mounting hole locations](#) section for details of the location of the bracket mounting holes on the rear of your display.

10. Secure the display using the provided mounting fixings (bolt, washer, lock nut and foot. In 4 locations.

Depending on the thickness of the mounting surface the washer and lock nut may be located:

1. between the mounting bracket and mounting feet (as shown in (1) and (2) below, or
2. after the mounting bracket as shown in (3) and (4) below.

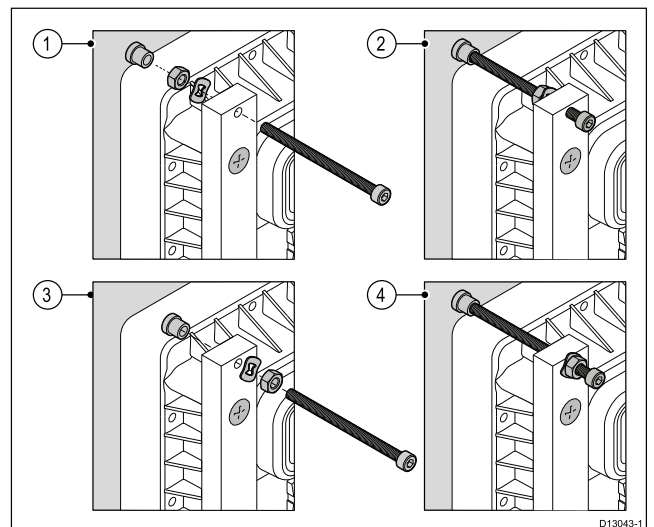

11. Using a suitable allen key, tighten the bracket mounting bolts so that the feet are tight against the rear of the mounting surface.

- Using a suitable sized wrench tighten the lock nut against the washer and the mounting bracket to lock in position.

The lock nut should be tightened sufficiently to securely hold the display in position. Do not overtighten.

Note: The supplied gasket provides a seal between the unit and a suitably flat and stiff mounting surface or binnacle. The gasket should be used in all installations. It may also be necessary to use a marine-grade sealant if the mounting surface or binnacle is not entirely flat and stiff or has a rough surface finish.

5.6 Surface mounting the card reader

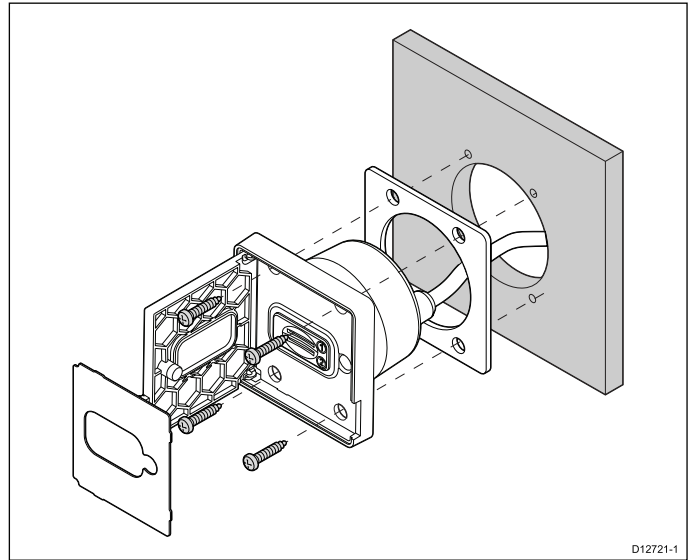

- Check the selected location for the unit. A clear, flat area with suitable clearance behind the panel is required.
- Before modifying the mounting surface, refer to the dimensions supplied in this document to ensure there is enough space for the unit and cable.
- Fix the supplied mounting template to the selected location, using masking or self-adhesive tape.
- Drill 4 holes as indicated on the mounting template to accept the fixings.
- Using a 40 mm (1.6 in) hole cutter, drill out the cut-out area identified on the mounting template.
- Ensure that the card reader fits into the removed area and then remove rough edges.
- Affix the supplied gasket onto the rear of the card reader and press firmly onto the flange.
- Feed the cable through the hole and connect to the multifunction display's card reader connector.
- Secure using the fixings provided.
- Insert the card reader label over the top of the card reader slots so that the mounting screw locations are covered.

Note: The appropriate tightening torque and drill bit size to use depends on the thickness of the mounting surface and the type of material it is made from.

Note: The supplied gasket provides a seal between the unit and a suitably flat and stiff mounting surface or binnacle. The gasket should be used in all installations. It may also be necessary to use a marine-grade sealant if the mounting surface or binnacle is not entirely flat and stiff or has a rough surface finish.

Chapter 6: Getting started

Chapter contents

- [6.1 Display power on page 82](#)
- [6.2 Controls on page 83](#)
- [6.3 Homescreen overview — Touch only displays on page 85](#)
- [6.4 Pages on page 87](#)
- [6.5 Applications on page 88](#)
- [6.6 Splitscreen controls on page 89](#)
- [6.7 Screen overview on page 90](#)
- [6.8 Basic touchscreen operations on page 93](#)
- [6.9 Multi-Touch gestures on page 94](#)
- [6.10 Initial set up procedures on page 94](#)
- [6.11 Enabling autopilot control on page 97](#)
- [6.12 Engine identification on page 98](#)
- [6.13 Enabling AIS functions on page 100](#)
- [6.14 Shared preferences on page 100](#)
- [6.15 Software updates on page 101](#)
- [6.16 Learning resources on page 102](#)

6.1 Display power

Note: PowerSave mode is automatically cancelled if an alarm event occurs.

Powering the display on

1. Press the **POWER** button on the display.
2. Select **Accept** to acknowledge the disclaimer message.

Putting the display into Standby

1. Press and hold the **POWER** button until the countdown reaches zero.

If the **POWER** button is released before the countdown reaches zero, normal operation is resumed.

Standby mode allows the internal **SeaTalk^{hs}** network hub and PoE functions of the display to remain active whilst all other functions are powered off.

Refer to the *Technical specification* for details on power consumption when in Standby mode.

Note: To completely power off the display so that it is no longer consuming power the display must be isolated from the power supply via the distribution panel or breaker.

PowerSave mode

In PowerSave mode all functions of the multifunction display remain active, but the unit is placed into a low power state. PowerSave mode is automatically cancelled when an alarm event occurs.

Note: To ensure user safety the PowerSave feature will not be available if:

- any connected radars are switched on
- the multifunction display is providing autopilot control in a system without a dedicated pilot head and the autopilot is engaged.

Attention A gS Series MFD in PowerSave mode will continue to consume some power from your vessel's batteries. The unit could drain your batteries if left in PowerSave mode for prolonged periods of time. When switching off the power to your vessel, ensure that the unit is switched off at the power distribution panel or breaker. For more information on the amount of power consumed by the unit in PowerSave mode, refer to [Chapter 31 Technical specification](#).

Enabling PowerSave mode

To enable PowerSave mode follow the steps below.

1. Ensure any radars connected to the system are switched off.
2. Press the **POWER** button.
The shortcuts menu is displayed.
3. Select **PowerSave Mode**.
The multifunction displays is now in PowerSave mode.
4. You can wake the unit from PowerSave mode at anytime by pressing the **Power** button or any button on a connected keypad.

6.2 Controls

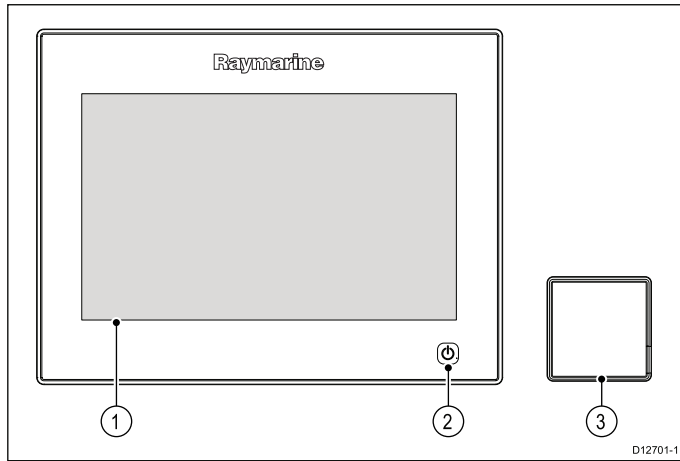

	Description	Functions
1	Touch-screen	Touch the screen to operate functions, including all menu operations.
2	Power	<ul style="list-style-type: none"> Press once to switch the unit on. When powered on, press the Power button again open the Shortcuts page. When powered on, press and hold to put the display into Standby mode. If an integrated pilot is engaged, press and hold to put the autopilot into STANDBY mode.
3	Card reader	Open the card door to insert or remove a MicroSD card. There are 2 card slots (labelled 1 and 2), used for electronic charts and archiving waypoint, route, track and settings data.

Keypad controls

Connecting the keypad allows you to control your multifunction display remotely.

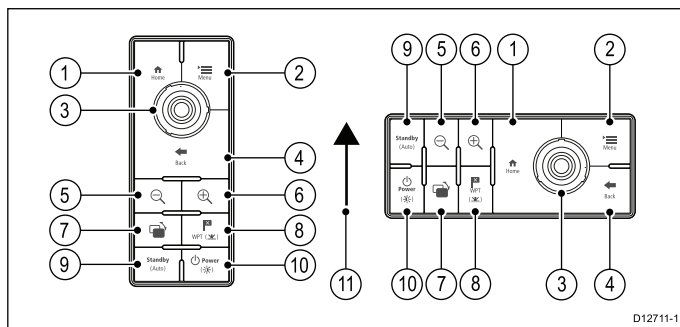

1. **Home** — press to return to the Homescreen.
2. **Menu** — accesses menus. Press again to close menus.
3. **UniControl** — provides a rotary control and a joystick with an OK push button for using menus and applications.
4. **Back** — press to return to a previous menu or dialog level.
5. **Range Out** — press to range out.
6. **Range In** — press to range in.

7. **Switch Active** — press to switch the active pane, or to switch the active multifunction display (in multiple display systems).
8. **WPT / MOB** — press and release to access the waypoint options. Press again to place a waypoint. Press and hold to place a Man Overboard (MOB) marker at your current position.
9. **Standby (Auto)** — press to disengage integrated autopilot, press and hold to activate Auto mode on integrated autopilot.
10. **Power** — see table below:

Configuration	Display State	Momentary press	Press and hold
1 Multifunction display	Off / Standby	* Power on	—
	On	Open shortcuts page	Power off / put into Standby
Multiple multifunction displays	All displays Off or in Standby	* Power on all displays	—
	All displays On	Open shortcuts page on active display	Power down all displays
	1 Display On and 1 display Off or in Standby	Open shortcuts page on active display	Power down active display

Note: * Only applicable to gS Series displays. a Series, c Series and e Series displays cannot be powered on using the keypad.

Note: In a multiple display configuration, where displays are in different states, displays that are turned off can only be turned on using the **Power** button on the display.

11. Joystick Up direction.

UniControl

Non-touch, HybridTouch and the remote keypad include a UniControl which consists of Rotary, Joystick and a push button control.

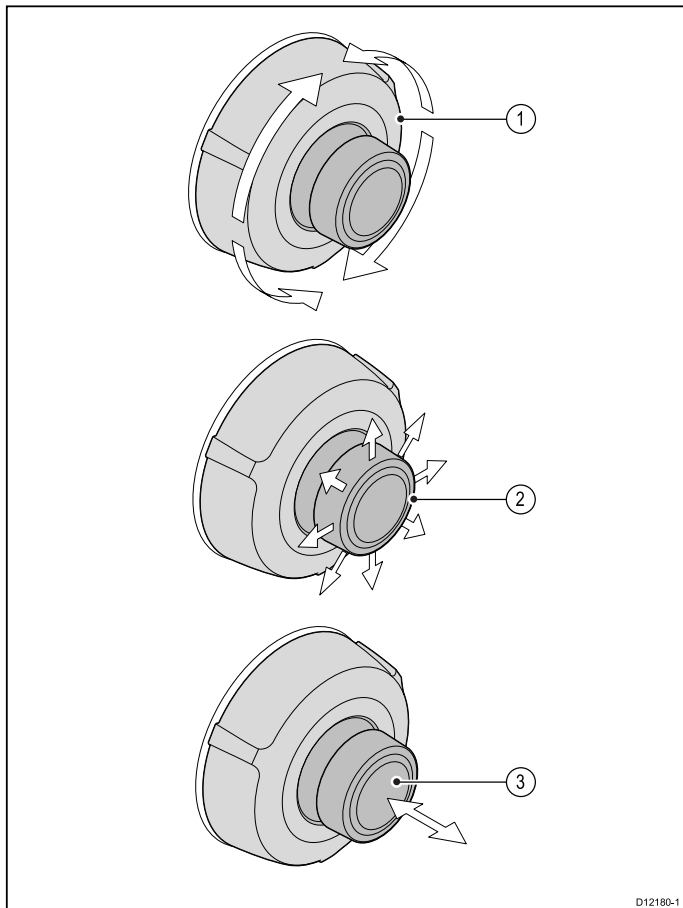

D12180-1

1. **Rotary** — use this to select menu items, move the on-screen cursor, and adjust the range in the chart and radar applications.
2. **Joystick** — use this to move the cursor position in applications, pan up, down, left and right in the chart, weather and fishfinder applications or to cycle through datapages in the data application.
3. **OK button** — push the end of the joystick to confirm a selection or entry.

Touch icons

Touchscreen multifunction displays can use the **BACK** and **CLOSE** icons to move between the different levels of menus available in each application.

	Back — go back one level (same effect as pressing the BACK button).
	Close — close all open menus (same effect as pressing the MENU button).

Using the cursor

The cursor is used to move around the screen.

	The cursor appears on the screen as a white cross.
	If the cursor has not been moved for a short period of time, it changes to a circle with a cross in it, to make it easier to locate on the screen.
	The cursor is context-sensitive. When it is placed over an object such as a waypoint or chart feature, it changes color and a label or information associated with the object is displayed.

List of cursor labels

Label	Feature	Application
A/B	Ruler line	Chart
AIS	AIS target	Chart
COG	Course Over Ground vector	Chart
CTR	Center of radar	Radar
FLT	Floating EBL/VRM	Radar
GRD	Guard zone	Radar
HDG	Heading vector	Chart
MARPA	MARPA target	Radar
MOB	Man Over Board marker	Chart, Radar
POS	Vessel's position	Chart
RTE	Route leg	Chart
SHM	Ship's Heading Marker	Radar
TIDE	Tide indicator	Chart
TRACK	Track line	Chart
VRM/EBL	VRM and EBL, 1 or 2	Radar
WIND	Wind indicator	Chart
WPT	Waypoint	Chart, Radar

6.3 Homescreen overview — Touch only displays

The Homescreen provides a central point of access for your display's applications, data and settings.

- The Homescreen provides quick access to your data (waypoints, routes, tracks, images and videos) and backup settings.
- The Homescreen consists of a number of Homescreen pages. Swipe the screen left or right with your finger to scroll through the available Homescreen pages.
- Each Homescreen page consists of a number of icons. Applications are started by selecting the relevant icon.



Screen item	Description
1	Waypoint — select the icon to access the waypoint list. Select and hold on the icon to place a Man Overboard (MOB) marker at your vessel's current position.
2	My Data — this icon enables you to centrally manage your data including route, track, and waypoint lists. You can also access saved pictures and videos and backup settings.
3	Customize — select this icon to configure application pages and display preferences.
4	Set-up — select this icon to access the system set-up menus.
5	Icon — each icon represents an application page. A page can display multiple applications simultaneously.
6	Status bar — the status icons confirm the status of externally-connected equipment, including GPS, AIS, radar, sonar and autopilot units.

Accessing the homescreen

The homescreen can be accessed from any application.

To access the homescreen follow the steps below:

1. Select the homescreen icon on-screen.

Databar status symbols











The status symbols on the databar confirm whether the appropriate connections to your system have been made.

The symbols show the status for the following:

- Radar scanner.
- AIS receiver / transceiver.
- Sonar module.
- GPS receiver.
- Autopilot.





Autopilot status symbols

The autopilot status is indicated in the databar.

Symbol	Description
	Autopilot is in Standby mode.
	Autopilot is in Track mode.
	Autopilot is in Auto mode.
	No autopilot detected.
	Autopilot alarm active.
	Dodge mode is active.
	Fish mode is active.
	Autopilot calibration.
	Power steering active.
	Wind Vane mode is active.





Radar scanner status symbols



The radar scanner power mode status is indicated in the databar.

Symbol	Radar power mode	Description
	Transmit (TX)	Rotating icon, signifying that the scanner is on and transmitting. When SCANNER is set to ON, select this mode to activate the scanner. This is the usual mode of operation.
	Standby (STBY)	Static icon, indicating that the scanner is on but not transmitting, and the antenna is not rotating. The scanner does not transmit and the radar data is removed from the screen. This is a power-save mode used when the radar is not needed for short time periods. When you return to transmit mode, the magnetron does not need to warm up again. This is the default mode.
	Off	Scanner powered off when radar not required, but display is in use for other applications, such as the chart. When selected, the system counts down. During this time you cannot re-power the scanner.
 	Timed Transmit	Scanner switches between on/transmitting, and standby mode. Scanner goes into power save mode when constant use of radar is not required.

AIS status symbols



AIS status is indicated by a symbol in the databar.

Symbol	Description
	AIS unit is switched on and operating.
	AIS currently unavailable.
	AIS unit is switched off, or not connected.
	AIS unit is in Silent Mode.
	AIS unit is in Silent Mode, with active alarms.

Symbol	Description
	AIS unit is connected and switched on, but has active alarms.
	AIS unit is connected and switched on, but the dangerous and lost alarm is disabled.



Sonar status symbols

The sonar status is indicated in the databar.

Symbol	Description
	Symbol animated: the sonar module is connected and transmitting.
	Symbol static: the sonar module is connected but not transmitting.
	Symbol greyed-out: the sonar module is not connected, or is not detected.

GPS status symbols

The GPS receiver status is indicated in the databar.

Symbol	Description
	A GPS receiver is connected and has obtained a fix.
	A GPS receiver is not connected, or cannot obtain a fix.



6.4 Pages

Pages are made up of 1 to 4 panes that are used to display applications on your multifunction display (MFD).

Pages are accessed using the icons on the Homescreen.

- You can create up to 2 application panes per page using an MFD that has a screen size of 7 inches or less.
- You can create up to 4 application panes per page using an MFD that has a screen size of greater than 7 inches.
- MFDs with a screen size of 7 inches or less can view pages with more than 2 application panes but only if they are sharing the Homescreen of an MFD which is capable of creating those pages.

Pages can be customized, enabling you to group your applications into different pages, each designed for a specific purpose. For example, you could have a page that includes the chart and fishfinder applications, suitable for fishing, and another page that includes the chart and data applications, which would be suitable for general sailing.

 <p>Fishfinder</p>	<p>Icon for a page featuring a single application.</p>
 <p>Chart/Data/Fish</p>	<p>Icon for a page featuring multiple applications.</p>

You can also define the layout for each page, which determines how the applications are arranged on the screen.

Setting the Power-up page

You can setup your multifunction display to show a page instead of the Homescreen at power up.

From the Homescreen:

1. Select **Customize**.
2. Select **Display Preferences**.
3. Select **Starting page**.

A list of options is displayed

- Homescreen — Homescreen is displayed after power-up.
- Last page — The page last viewed is displayed after power-up
- Choose page — The page you select will be displayed after power-up

4. If selecting Choose page the Homescreen is displayed.



5. Select the icon for the page you want displayed when the display is turned on.

The starting page setting applies to each individual display and is not automatically shared on networked displays.

Changing an existing page on the homescreen

With the homescreen displayed:

1. Select **Customize**.
2. Select **Homescreen**.
3. Select **Edit Page**.
4. Select the page icon that you want to change. The Customize menu options are displayed.
5. Select the appropriate page layout (for example, "Splitscreen").
6. Select the application(s) you want to display on the page, either by selecting the relevant menu item or dragging it over to the displayed page.
7. Select **Finish**. The Rename Page dialog is displayed.
8. Use the on-screen keyboard to name the page, then select **Save**.

Changing an empty page

With the homescreen displayed:

1. Select **Customize**.
2. Select **Homescreen**.
3. Select **Edit Page**.
4. Select an empty page icon (labelled "Customize"). The Customize menu options are displayed.
5. Select the appropriate page layout (for example, "Splitscreen").
6. Select the application(s) you want to display on the page, either by selecting the relevant menu item or dragging it over to the displayed page.
7. Select **Finish**. The Rename Page dialog is displayed.
8. Use the on-screen keyboard to name the page, then select **Save**.

Moving a page on the homescreen

With the homescreen displayed:

1. Select the **Customize** icon.
2. Select **Homescreen**.
3. Select **Swap Page**.

4. Select the page icon that you want to move.
5. Select the page icon that you want to swap positions with.

The page icon is moved to the new position.

Renaming a page on the homescreen

With the homescreen displayed:

1. Select the **Customize** icon.
2. Select **Homescreen**.
3. Select **Rename Page**.
4. Select the page that you want to rename.
The on-screen keyboard is displayed.
5. Using the on-screen keyboard, enter the new name for the page.
6. Select **SAVE**.

Deleting a page from the homescreen

With the homescreen displayed:









1. Select the **Customize** icon.
2. Select **Homescreen**.
3. Select **Delete Page**.
4. Select the page that you want to delete.
The page is deleted.

Resetting the homescreen to default settings

With the homescreen displayed:

1. Select the **Customize** icon.
2. Select **Homescreen**.
3. Select **Reset**.
A warning message is displayed asking for confirmation.
4. Select **Yes** to reset the homescreen to the default range of pages, or **No** to cancel the operation.

6.5 Applications

	<p>Chart application — provides a 2D or 3D graphical view of your charts to help you navigate. Waypoint, route, and track functions enable you to navigate to a specific location, build and navigate routes, or record where you've been. Chart cards provide higher levels of detail and 3D views.</p>
	<p>Fishfinder application — with a transducer and a sonar variant multifunction display or compatible Sonar Module, you can use the fishfinder application to help you accurately distinguish between different sizes of fish, bottom structure, and underwater obstacles. You can also view sea depth and temperature data and mark points of interest such as fishing spots or wrecks.</p>
	<p>Radar application — with a suitable radar scanner, you can use the radar application to track targets and measure distances and bearings. A number of automatic gain presets and color modes are provided to help you get the best performance from your radar scanner.</p>
	<p>Data application — view system and instrument data on your multifunction display, for a range of compatible instruments. Use the joystick or touchscreen to scroll through the available data pages.</p>
	<p>Weather application — (North America only). With a suitable weather receiver connected to your system, the weather application overlays historical, live, and forecasted weather graphics on a world map.</p>
	<p>Thermal cam application — view and control a thermal camera using a compatible multifunction display.</p> <div data-bbox="1045 1552 1473 1664" style="border: 1px solid black; padding: 5px;"> <p>Note: The thermal camera application is not available on a6x and a7x variant MFDs.</p> </div>
	<p>Camera application — view a video or camera source on your multifunction display.</p>
	<p>Doc Viewer — view pdf documents stored on a MicroSD card.</p>

	<p>FUSION Link application — link to and control a compatible Fusion entertainment system from your multifunction display.</p>
	<p>Sirius Audio application — control Sirius radio from your multifunction display.</p>
	<p>User Manual — Opens the English version of the product user manual stored on the display. To open translated user manuals stored on memory card use the Doc Viewer.</p>

6.6 Splitscreen controls

When viewing a page with more than 1 application displayed you can switch applications from the splitscreen view to fullscreen view.

Example 1 — Splitscreen page



Example 2 — Fishfinder application expanded to Fullscreen

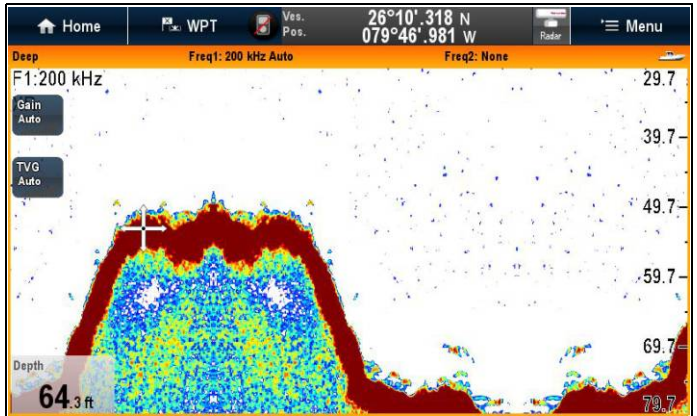

Selecting the active window

When viewing a splitscreen page you can select the active application and view it fullscreen by following the steps below.

With a page featuring multiple applications displayed:

1. Touch anywhere inside the application you want to make active.
A border appears around the application, indicating that it is active.
2. Select **Menu**.
3. Select **Fullscreen** to view the active application in fullscreen, or
4. Select **Splitscreen** to return to the splitscreen view.



Selecting the active window using Non-touch controls

When viewing a splitscreen page you can select the active application and view it fullscreen using the MFD's physical buttons or a remote keypad.

With a page featuring multiple applications displayed:

1. Press the  **Switch Active** button.
The active pane pop up is displayed:
2. Press the **Switch Active Pane** button or use the **Rotary control** to cycle the active application.

- Use the **Range in** or **Range out** controls to switch the active application between splitscreen and fullscreen views.

Switching the active pane or display using the keypad

The Switch Active button is used to switch the active pane on a multi application page and / or to switch the active display.

With multiple displays connected and / or a multiple application page displayed:

Cycle sequence

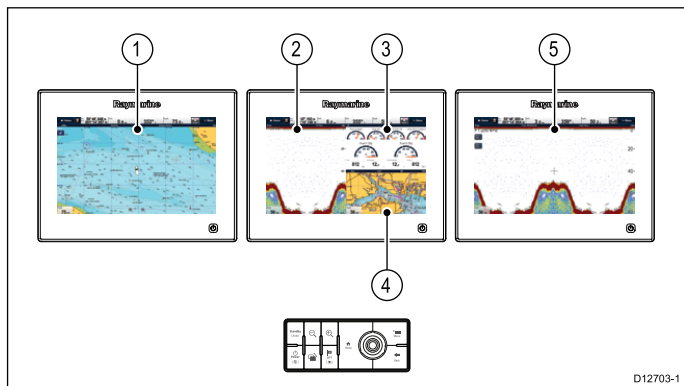

- Press the **Switch Active** button to enter switch mode.
- Use the **Rotary Control** to cycle through the available panes and / or displays.
The keypad will cycle through displays in the order in which they were paired. On multi application pages the Range buttons can be used to switch the active application between full and splitscreen.
- Press the **Back** button or the **Switch Active** button to exit switch mode.

6.7 Screen overview

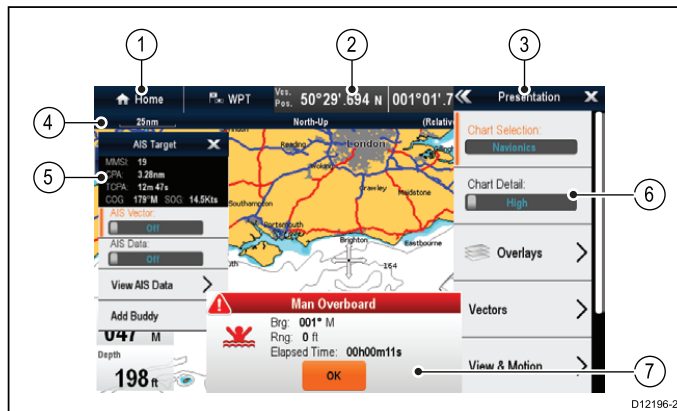

Screen item	Description
1	Home — select the Home icon to access the homescreen.
2	Databar — provides information about your vessel and its environment. The position and type of information in the databar can be customized from the Homescreen > Customize > Databar Set-up menu, if required.
3	Menu — the menu options are specific to the application that you are currently using.
4	Pop-up menu — menu options are displayed when the Menu is selected.
5	Pop-up messages — alert you to a situation (such as an alarm), or unavailable function. Pop-up messages may require a response from you — for example, select OK to silence alarms.
6	Dialogs — enable data to be selected, edited or entered. Use in many common functions — for example, editing a waypoint.
7	Context menu — provides information and options specific to each application.
8	Status bar — provides information specific to each application. This information cannot be edited or moved.

Menus

Menus enable you configure settings and preferences.

Menus are used in the:

- Homescreen** — to configure your multifunction display and externally-connected equipment.
- Applications** — to configure the settings for that particular application.



Screen item	Description
1	<p>Back</p> <ul style="list-style-type: none"> Displays with a touchscreen — Select the onscreen Back icon to go back to the previous menu. Non-touchscreen or HybridTouch displays — Use the Back button to go back to the previous menu.
2	<p>Function icons — Some dialogs include icons which can be selected to access additional functions. For example, in the Waypoint List dialog, the Sort by icon can be used to change how the waypoints list is sorted.</p>
3	<p>Menu / List item</p> <ul style="list-style-type: none"> Displays with a touchscreen — Momentarily touching an item automatically selects the item and displays the item options menu. Non-touchscreen or HybridTouch displays — Use the Rotary control to highlight an item, and the Ok button to select it and display the item options menu.
4	<p>Close</p> <ul style="list-style-type: none"> Displays with a touchscreen — Select the onscreen Close icon to close the dialog. Non-touchscreen or HybridTouch displays — Use the Back button to close the dialog.
5	<p>Scroll bar</p> <ul style="list-style-type: none"> Displays with a touchscreen — To scroll through the available items, press and hold your finger on the scroll bar and drag it up or down. Non-touchscreen or HybridTouch displays — To scroll through the available menu items, use the Rotary control.

Screen item	Description
1	<p>Back — On displays with a touchscreen you can press the onscreen << (back) icon to go back to a previous menu. On non-touchscreen displays or HybridTouch displays use the Back button.</p>
2	<p>Close — On displays with a touchscreen you can press the onscreen X (close) icon to go back to a previous menu. On non-touchscreen displays or HybridTouch displays use the Back button to back out of the menu structure.</p>
3	<p>Selected menu option — the menu option currently selected will be highlighted.</p>
4	<p>Scroll bar — indicates that further menu items are available by scrolling the menu. On displays with a touchscreen to scroll through the available menu items, press and hold your finger on the menu and drag it up or down. On non-touchscreen displays or HybridTouch displays use the Rotary control.</p>
5	<p>On / Off switch — On displays with a touchscreen you can select onscreen menu items to switch features On or Off to enable or disable the function. On non-touchscreen displays or HybridTouch displays use the OK button to switch the function On or Off.</p>

Dialogs

Dialogs are fullscreen menus that enable you to manage data items such as waypoints and routes.

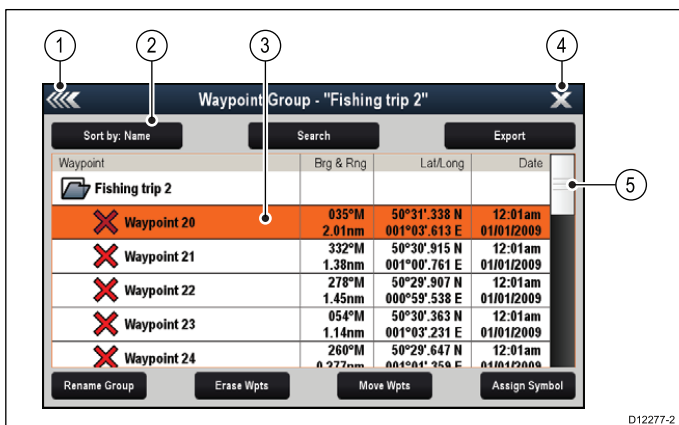

Shortcuts page

A number of useful functions can be accessed from the Shortcuts page.

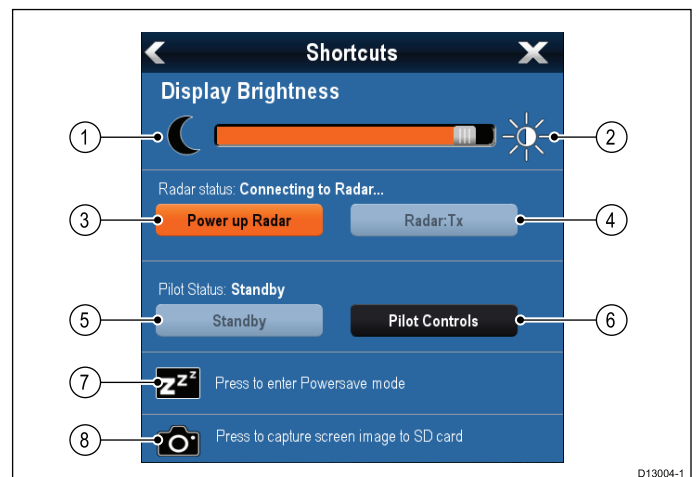

1	Decrease display brightness
2	Increase display brightness
3	Power up / Power down Radar
4	Radar standby / Radar transmit
5	Autopilot standby (during active navigation)
6	Display pilot control dialog
7	PowerSave mode
8	Screenshot / Screen capture

Edit dialogs

Edit dialogs enable you to edit the details of data items stored on your multifunction display, such as waypoints, routes, and tracks.

Selecting a text field displays the onscreen keyboard, which can be used to edit the details.

Editing information in dialogs

With the dialog displayed:

1. Select the field you want to edit.

The onscreen keyboard is displayed:

2. Use the onscreen keyboard to make the changes.
3. Select **SAVE** to save the changes.

Entering special or accented characters

With the onscreen keyboard displayed:

1. Select the onscreen keyboard's **àèò** key.
2. Select the character you want to accent.

The available accented characters are displayed above the text entry field.

3. For characters that have multiple available accents, use the character key to toggle between them.

4. Select the **àèò** key to enter the character.

Numeric menu items

Numeric menu items display numeric data and enables you to either select a predefined value or to increase and decrease the value as required.



Editing numerical settings

To edit numerical values you can use either the onscreen numeric adjust control, onscreen numeric keypad or the **Rotary Control** on a non-touch or HybridTouch display to increase or decrease numeric values.

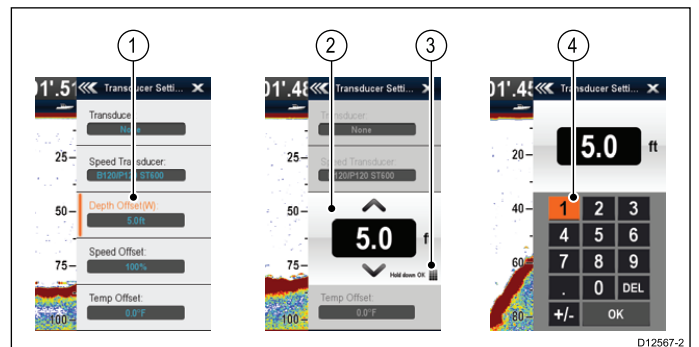

1. Select the numeric data field you want to edit. The numeric adjust control is displayed.
2. Adjust the setting to the required value using:
 - i. The **Rotary control** — Non-touchscreen or HybridTouch displays, or
 - ii. The onscreen **Up** and **Down** arrows — Touchscreen displays.
3. To access the on-screen numeric keypad:
 - Touch operation — Select the onscreen keypad icon from the numeric adjust control.
 - Non-Touch operation — Press and hold the **Ok** button.

The onscreen numeric keypad is displayed.

4. Enter the required value.
5. Select **Ok** to exit the numeric keypad and return to the menu.

Using slider bar controls

Slider bar controls provide a graphical representation of numeric data and enables you to quickly change setting values.

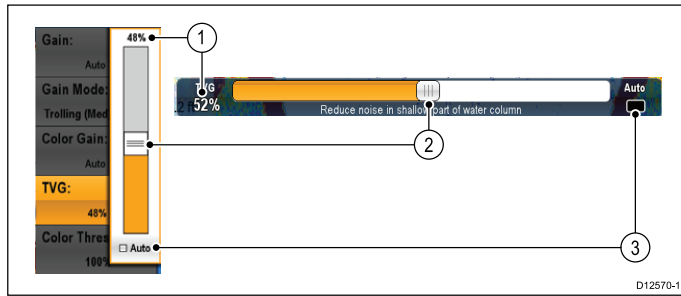

Item	Description	Non—Touch operation	Touch operation
1	Current value	N/A	N/A
2	Slider control	Use the Rotary control to adjust value	Slide the slider Up or Down to adjust value.
3	Auto	Press Ok button to switch between Auto and manual adjustment.	Select to switch between Auto and manual adjustment.

Using control dialogs

Control dialogs enable you to control externally connected equipment, such as an autopilot unit.

The following diagram shows the main features of a typical control dialog:

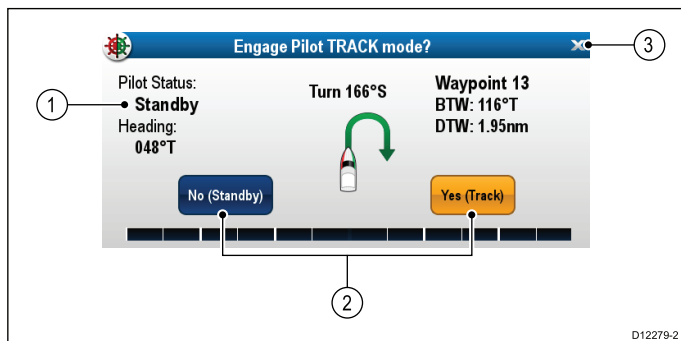

Screen item	Description
1	Status — provides status information for the connected equipment. For example, the Pilot Control dialog displays the locked heading and current navigation mode for a connected autopilot unit.
2	Control icons — provide direct control of the connected equipment. For example, the Pilot Control dialog Standby and Track icons enable you to instruct a connected autopilot unit to perform specific functions.
3	Close — Closes the control dialog.

6.8 Basic touchscreen operations

Placing and moving the cursor using touch

To place or move the cursor around the screen on a touchscreen multifunction display follow the steps below.

1. Touch the screen at any position on the screen to place the cursor there.

Touchscreen lock

On a multifunction display with HybridTouch you can lock the touchscreen to prevent accidental use.

For example, locking the touchscreen is particularly useful in rough water or weather conditions.

The touchscreen can be locked and unlocked from the homescreen. The touchscreen can only be unlocked using physical buttons.

Locking the touchscreen - touch only displays

When a touch only display is paired with an optional remote keypad the touchscreen can be locked.

From the Homescreen:

1. Select the **Set-up** icon.
2. Select **Touch-Lock** so that On is highlighted.

The touchscreen is now locked.

Unlocking the touchscreen - touch only displays

To unlock the touchscreen of a touch only display when paired with a remote keypad follow the steps below.

From the Homescreen:

1. Select the **Set-up** icon.
2. Select **Touch-Lock** so that Off is highlighted.

The touchscreen is now unlocked.

6.9 Multi-Touch gestures

Raymarine a Series and gS Series multifunction displays support multi-touch.

Multi-touch means that the display is capable of recognizing multiple simultaneous touch inputs. This means that you can use 2 or more fingers on the screen at the same time to perform multi-touch gestures.

Pinch to Zoom

The pinch to zoom gestures can be performed on multifunction displays that support multi-touch.

Pinch to zoom consists of 2 actions:

- Move 2 fingers apart to zoom in.
- Move 2 fingers together to zoom out.



Pinch to Zoom can be used in the following applications:

- Chart application.
- Weather application.

6.10 Initial set up procedures

Once your display has been installed and commissioned, Raymarine recommends that you perform an initial set up procedure.

Startup wizard

When you power-up the display for the first time or after a system reset a Startup Wizard is displayed. The wizard guides you through the following basic configuration settings:

1. Language
2. Boat type
3. Configure Units (Units of measure)
4. Boat Details
 - Minimum Safe Depth
 - Number of engines
 - Total fuel capacity (TFC)
 - Number of fuel tanks
 - Number of batteries

Note: These settings can also be set at any time using the menus accessible from **Homescreen > Customize**.

Additional settings

In addition to the settings covered by the Wizard, it is also recommended that the following initial set up tasks are completed:

- Set your date and time preferences.
- Adjust the display brightness (and set up a shared brightness scheme if appropriate).
- Designate the data master.
- Select the GPS data source.
- Familiarize yourself with the product using Simulator Mode.



Adjusting the display brightness



1. Press the **POWER** button once.
The Shortcuts menu is displayed.
2. Adjust the brightness to the required level using the on-screen brightness slider bar control, or
3. Touch the Sun icon to increase the brightness level or the Moon icon to decrease the brightness level.

Note: The brightness level can also be increased by pressing the **Power** button multiple times.

Adjusting the display brightness

1. Press the **POWER** button once.
The Shortcuts menu is displayed.
2. Adjust the brightness to the required level using the **Rotary control**.

Note: The brightness level can also be increased by pressing the **Power** button multiple times.

Minimum safe vessel depth

As part of the **Initial startup wizard** the **Minimum Safe Depth** value can be set.

Minimum Safe Depth can be established by adding together:

- Maximum Vessel Draft (i.e. the distance from the waterline to the lowest point of a vessel's keel.)
- Safety Margin (an adequate clearance below the keel to allow for draft variation and changes in water or bottom conditions.)

i.e.: **Minimum Safe Depth** = Maximum Vessel Draft + Safety Margin.

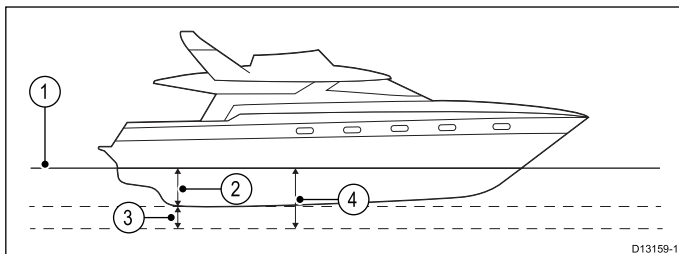

1. Waterline
2. Maximum Vessel Draft
3. Safety Margin
4. **Minimum Safe Depth**

Important: The information below is provided for guidance only and is not exhaustive. Some influencing factors can be unique to certain vessels and / or areas of water and may not be listed below. You should ensure you account for **ALL** factors that apply to your current situation when making calculations.

Some of the factors that can influence how much a vessel draws are shown below:

- **Vessel displacement (weight)** — A vessel's draft will increase when it is fully laden when compared with its unladen displacement.
- **Water type** — A vessel's draft will increase by approximately 2% to 3% in fresh water compared to seawater.

Some of the factors that should be taken into account when calculating a Safety Margin are:

- **Vessel maneuvering characteristics** — A vessel's draft increases due to squat, trim, roll, pitch and heave.
- **Chart accuracy** — The electronic chart depth may not be accurate or the true depth may have changed since the last survey.
- **Weather conditions** — High air pressure, and prevailing wind strength and direction can affect wave height.



Warning: Minimum Safe Depth

The **Minimum Safe Depth** setting is used during **Autorouting** to restrict the created route from entering water that is too shallow for the vessel.

Bottom depth is taken from compatible electronic navigational charts and **Minimum Safe Depth** is a user calculation. As both of these factors are outside of Raymarine's control, Raymarine will not be held liable for any damage, physical or otherwise, resulting from the use of the **Autorouting** feature or the **Minimum Safe Depth** setting.

Setting the vessel Minimum Safe Depth

Follow the steps below to enter your vessel's **Minimum Safe Depth**.

From the Homescreen:

1. Select **Customize**.
2. Select **Boat Details**.
3. Select **Min. Safe Depth**.
4. Enter your calculated Minimum Safe Depth.

Setting time and date preferences

With the homescreen displayed:

1. Select **Customize**.
2. Select **Time and Date Set-up**.
3. Use the **Date Format**, **Time Format**, and **Local Time: UTC** menu items to set your time and date preferences.

Data master

Any system containing more than one networked multifunction display must have a designated data master.

The data master is the display which serves as a primary source of data for all displays, it also handles all external sources of information. For example the displays may require heading information from the autopilot and GPS systems, usually received through a SeaTalk^{ng} or NMEA connection. The data master is the display to which the SeaTalk, NMEA and any other data connections are made, it then bridges the data to the SeaTalk^{hs} network and any compatible repeat displays. Information shared by the data master includes:

- Cartography

- Routes and waypoints
- Radar
- Sonar
- Data received from the autopilot, instruments, the engine and other external sources.

Your system may be wired for redundancy with data connections made to repeat displays. However these connections will only become active in the event of a fault and/or reassignment of the data master.

In an autopilot system which does not contain a dedicated pilot control head the Data master also acts as the control for the autopilot.

Designating the data master

For systems with 2 or more displays the following task must be performed on the multifunction display that you want to designate as the data master.

With the homescreen displayed:

1. Select **Set-up** .
2. Select **Maintenance**.
3. Select **Data Master**.
4. Select the display that you want to designate as the data master.

Simulator mode

The Simulator mode enables you to practice operating your display without data from a GPS antenna, radar scanner, AIS unit, or fishfinder.

The simulator mode is switched on / off in the **System Setup Menu**.

Note: Raymarine recommends that you do NOT use the simulator mode whilst navigating.

Note: The simulator will NOT display any real data, including any safety messages (such as those received from AIS units).

Note: Any system settings made whilst in Simulator mode are NOT transmitted to other equipment.

Enabling and disabling simulator mode

You can enable and disable simulator mode by following the steps below.

With the homescreen displayed:

1. Select **Set-Up** .
2. Select **System Settings**.
3. Select **Simulator**.
4. Select On to turn simulator mode on, or
5. Select Off to turn simulator mode off.

Note: The Demo movie option is for retail demonstration purposes only.

Disabling and enabling the auxiliary alarm

If there is more than one alarm fitted (e.g. auxiliary alarm and remote keypad) then the auxiliary alarm can be enabled or disabled.

From the homescreen:

1. Select **Set-up**.
2. Select **Remote Devices**.
3. Select **Auxiliary Alarm**.
4. Select **Auxiliary Alarm**.

Selecting Auxiliary Alarm will switch the auxiliary alarm On and Off.

Note: If the auxiliary alarm is the only alarm in the system then it is permanently enabled.

Pairing the keypad

The keypad can control 1 or more multifunction displays. Multiple keypads can be connected to a system. Each keypad can be paired with up to 4 multifunction displays.

With the keypad connected to the multifunction display:

1. Select **External Keypad** from the External Devices menu: **homescreen > Set-up > System Settings > External Devices > External Keypad**.
2. Select **Pair Keypad**.
3. Press any button on the external keypad.
4. From the pop-up message select the orientation of the keypad.

Either landscape or portrait orientations are available.

The keypad is now paired.

Unpairing the keypad

The keypad can be unpaired from an individual display.

1. Select **External Keypad** from the External Devices menu: **homescreen > Set-up > System Settings > External Devices > External Keypad**.
2. Select **Clear Pairings**.
3. Select **Yes** to unpair the keypad with the display.

6.11 Enabling autopilot control

Enabling the autopilot control function — SeaTalk and SPX SeaTalk^{ng} autopilots

To enable control of your SeaTalk or SPX SeaTalk^{ng} autopilot using your multifunction display follow the steps below.

From the Homescreen:

1. Select **Set-up**.
2. Select **System Settings**.
3. Select **Autopilot Control** so that On is highlighted.
Selecting Autopilot Control will switch the control between On and Off.

On a system containing multiple displays the pilot control is enabled on all displays at the same time.

Enabling the autopilot control function — Evolution autopilots

To enable control of your Evolution autopilot using your multifunction display follow the steps below.

From the Homescreen.

1. Select **Set-up**.
2. Select **System Settings**.
3. Select **External Devices**.
4. Select **Pilot Set-up**.
5. Select **Pilot control** so that On is highlighted.
Selecting Pilot control will switch the Autopilot control function on and off.

6.12 Engine identification

Engine data can be displayed on your MFD using the Data application, which provides some preset Engine pages for displaying some of the most common types of engine data.

Important: Before you can display Engine data on your MFD, you must:

- Ensure that your MFD is running LightHouse software version 8 or later.
- **Refer to the important “Engine setup with an ECI interface” and “Using the engine identification wizard” information.**
- Make the data connections, according to the instructions provided in the **87202 ECI Installation instructions**.
- Ensure all data buses are powered up (including engine data CAN buses, gateways, and also the SeaTalk^{ng} bus).
- Start the engine. It is important that only one engine is running at a time, to ensure that the system can isolate the correct engine data message.
- Run the **Engine identification wizard** to ensure that your engines are displayed in the correct order in the Data application.



Engine setup with an ECI interface

Before you can display engine data on your MFD, you may need to use the "Engine Identification wizard" on the MFD to setup the engines.

Important: When setting up on a multiple engine system, engines should always be turned on in sequence from port to starboard.

The following table details the different types of engine supported by the ECI interface unit, and the setup requirements for each:

Engine CAN bus protocol	Number of engines	Engine CAN bus configuration	Number of ECI units	Setup via wizard on MFD required
NMEA 2000	1	Single CAN bus	1	✗
NMEA 2000	2+	Single shared CAN bus	1	✗
NMEA 2000	2+	Separate CAN bus for each engine	1 for each CAN bus	✓
J1939	1	Single CAN bus	1	✗
J1939	2+	Single shared CAN bus	1	✗
J1939	2+	Separate CAN bus for each engine	1 for each CAN bus	✓

Engine interfacing without an ECI unit

For engines with a NMEA 2000 CAN bus it may be possible to connect to a Raymarine MFD via a SeaTalk^{ng} system without the use of a Raymarine ECI unit.

Refer to your engine dealer and also your local Raymarine dealer for advice on any engine instancing requirements and suitable connection cables.

Using the engine identification wizard

If your engine data appears in the wrong order on the engine data pages you can correct this by running the engine identification wizard.

From the Homescreen:

1. Select **Set-up > System Settings > External Devices > Engines Set-up**.
2. If required change the number of engines your vessel has by selecting **Num. of Engines:** and entering the correct number of engines.

You can select up to 5 engines.

3. Select **Identify engines**.

Important: It is important that only one engine is running at a time, to ensure that the system can isolate the correct engine data message.

4. Follow the onscreen prompts to complete the engine identification wizard.

The engines that will be included in the identification wizard are determined by the Number of engines set during step 2 above.

- i. Switch Off ALL vessel engines and select **Next**.

The wizard will run through all engines (max of 5 as defined in step 2 above) from port to starboard in sequence.

- ii. Turn On the **port engine** and select **OK**.
The wizard will now listen for data and assign the engine instance as the port engine.
 - iii. Turn On the **center port engine** and select **OK**.
The wizard will now listen for data and assign the engine instance as the center port engine.
 - iv. Turn On the **center engine** and select **OK**.
The wizard will now listen for data and assign the engine instance as the center engine.
 - v. Turn On the **center starboard engine** and select **OK**.
The wizard will now listen for data and assign the engine instance as the center starboard engine.
 - vi. Turn On the **starboard engine** and select **OK**.
The wizard will now listen for data and assign the engine instance as the starboard engine.
5. Select **OK** on the Identify Engines confirmation dialog.

The engines will now appear in the correct location on the engine data page.

6.13 Enabling AIS functions

Before proceeding ensure your AIS unit is connected to NMEA Port 1.

With the homescreen displayed:

1. Select **Set-Up**.
2. Select **System Settings**.
3. Select **NMEA Set-Up**.
4. Select **NMEA Input Port 1**.
5. Select the AIS 38400 option.
6. Select **Back** to return to the **System Settings** menu.
7. Select **External Devices**.
8. Select **AIS Unit Set-up**.

The AIS Unit Set-up menu is displayed.

9. Adjust the AIS options as appropriate.

6.14 Shared preferences

The Shared preferences scheme allows all compatible networked **MFDs** and instrument displays to share user preference settings. When a user preference is changed on 1 display device all compatible networked display devices are automatically updated to use the changed preference.

Shared preferences are applicable to the following devices:

- **MFDs** networked using **SeaTalk^{hs}**
- **MFDs** networked using **SeaTalk^{ng}**
- **SeaTalk^{ng}** instruments displays networked using **SeaTalk^{ng}**
- **SeaTalk** instruments displays networked via a **SeaTalk** to **SeaTalk^{ng}** converter.

Note: To ensure compatibility check that all devices are running the latest software versions. Check the **Raymarine[®]** website www.raymarine.com for the latest software for your products.

List of shared preferences

The table below shows the settings that are shared as part of the Shared preference scheme.

Units

- Speed units
- Distance units
- Depth units
- Wind units
- Temperature units
- Flow Rate units
- Volume Units
- Pressure units

Boat Details

- Boat Type
- Number of engines
- Number of fuel tanks
- Number of batteries

Time and Date

- Date Format
- Time Format
- Local Time (UTC) offset

System Preferences

- Bearing mode
- Variation (manual)
- Language

Data application

- Max RPM range
- RPM red zone
- RPM red zone value

6.15 Software updates

Raymarine's multifunction display software is updated regularly to provide new and enhanced features and improved performance and usability. You should ensure you have the latest software by regularly checking the Raymarine website for new software.

You can identify your multifunction display's current software version from the Limitations on Use (LoU) splash screen:

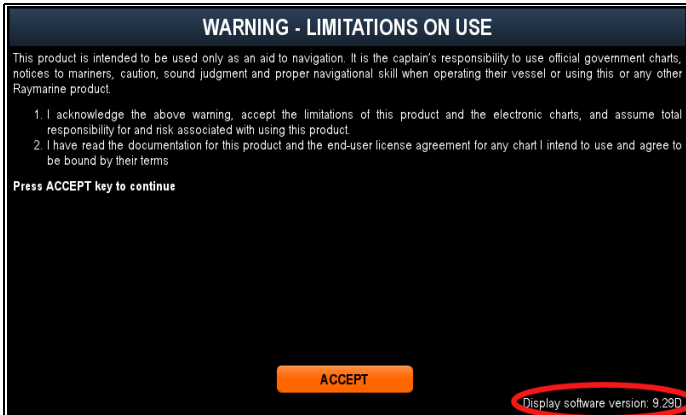

The software version can also be identified from the **Maintenance** menu.

The software update process can be used to update all multifunction displays and remote keypads that are connected to the same network.

Caution: Downloading software updates

The software update process is carried out at your own risk. Before initiating the update process ensure you have backed up any important files.

Ensure that the unit has a reliable power supply and that the update process is not interrupted.

Damage caused by incomplete updates are not covered by Raymarine warranty.

By downloading the software update package, you agree to these terms.

Updating the software

Software updates can be downloaded from the Raymarine website.

To perform a software update you will need:

- A PC or Apple Mac with an internet connection and a card reader.
- A FAT 32 formatted MicroSD card with SD card adaptor.

Note: Do not use a cartography chart card to save software update or user data / settings files.

1. Go to the Raymarine website www.raymarine.com
2. Click the **Service and Support** from the top banner.
3. Select **Software Updates** from the drop down list.

4. Select the relevant product.
5. Compare the latest available software against the software version on your multifunction display.
6. If the software on the website is newer than the software on your multifunction display select the option to download the software.
7. Place the MicroSD card into an SD card adaptor.
8. Place the SD card adaptor into the card reader of your PC or Mac.
9. Unzip the downloaded software update zip file to the MicroSD card.
10. Remove the MicroSD card from the SD card adaptor.
11. Backup your user data and settings by following the procedure described in section [8.4 Saving user data and user settings](#).
12. Insert the MicroSD card into the card reader of your multifunction display.

After a few seconds your multifunction display will alert you that a software update is available and which multifunction displays and remote keypads require the update.

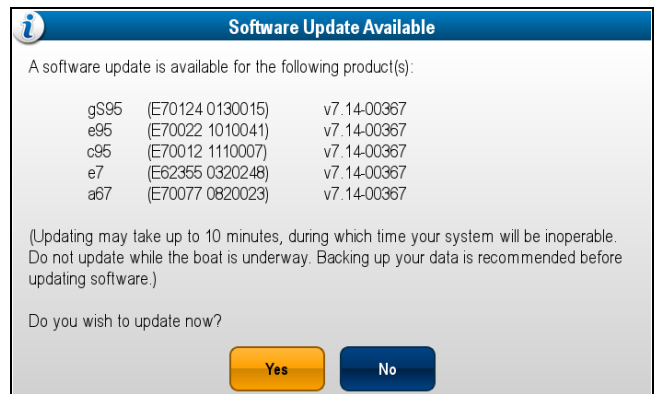

The software alert is only displayed once per power cycle.

13. Select **Yes** to begin the software update. The following steps will now take place:
 1. All networked multifunction displays will reboot and commence a simultaneous software update (During the software update the display with the software update memory card inserted will display a progress indicator.
 2. Once the networked displays have been updated the display containing the software update memory card will reboot and commence the software update.
 3. Once all displays have been updated the system will check to see if any connected remote keypads require a software update.

14. If you have a remote keypad connected then select **Yes** to update the keypad software update.



When the software update process has been completed a confirmation pop-up is displayed.

15. Select **OK** to confirm.
 16. Remove the MicroSD card from the card reader.
 17. Perform a factory reset of your multifunction displays following the procedure described in section [8.7 Resetting your system](#).
 18. Restore any saved user data and settings by following the procedure described in section [8.4 Saving user data and user settings](#)

Note: Turning on a display whilst it has a software update memory card inserted will start a standalone software update on that display only.

6.16 Learning resources

Raymarine has produced a range of learning resources to help you get the most out of your products.

Video tutorials

	<p>Raymarine official channel on YouTube:</p> <ul style="list-style-type: none"> • http://www.youtube.com/user/RaymarineInc
	<p>Video Gallery:</p> <ul style="list-style-type: none"> • http://www.raymarine.co.uk/view/?id=2679
	<p>Product Support videos:</p> <ul style="list-style-type: none"> • http://www.raymarine.co.uk/view/?id=4952

Note:

- Viewing the videos requires a device with an Internet connection.
- Some videos are only available in English.

Training courses

Raymarine regularly runs a range of in-depth training courses to help you make the most of your products. Visit the Training section of the Raymarine website for more information:

- <http://www.raymarine.co.uk/view/?id=2372>

FAQs and Knowledge Base

Raymarine has produced an extensive set of FAQs and a Knowledge Base to help you find more information and troubleshoot any issues.

- <http://www.raymarine.co.uk/knowledgebase/>

Technical support forum

You can use the Technical support forum to ask a technical question about a Raymarine product or to find out how other customers are using their Raymarine equipment. The resource is regularly updated with contributions from Raymarine customers and staff:

- <http://raymarine.ning.com/>

Chapter 7: System checks

Chapter contents

- [7.1 GPS Check on page 104](#)
- [7.2 GPS Status on page 104](#)
- [7.3 Raymarine GPS / GNSS receiver compatibility on page 105](#)
- [7.4 Radar check on page 106](#)
- [7.5 Sonar check on page 107](#)
- [7.6 Thermal camera setup and checks on page 108](#)

including satellite geometry, system errors in the data transmission and system errors in the receiver. A higher figure signifies a greater positional error. A typical receiver has an accuracy of between 5 and 15 m. As an example, assuming a receiver error of 5 m, an HDOP of 2 would represent an error of approximately 15 m. Please remember that even a very low HDOP figure is NO guarantee that your receiver is providing an accurate position. If in doubt, check the displayed vessel position in the Chart application against your actual proximity to a known charted object.

- **Estimated Horizontal Position Error (EHPE)** — EHPE is a measure of the estimated error of a position fix in the horizontal plane. The value displayed indicates that your position is within a circle radius of the stated size 50% of the time.
- **Fix status** — indicates the actual mode the receiver is reporting:
 - **Fix** — Satellite fix has been acquired.
 - **No Fix** — No satellite fix can be acquired.
 - **D Fix** — A differential beacon fix has been acquired.
 - **SD Fix** — A differential satellite fix has been acquired.
- **Position** — Displays the latitude and longitude position of your receiver.
- **Date / Time** — Displays the current date and time generated by the position fix in UTC format .
- **Mode** — Identifies whether the receiver is working in differential mode or non-differential mode.
- **Datum** — The receiver's datum setting affects the accuracy of the vessel position information displayed in the Chart application. In order for your receiver and MFD to correlate accurately with your paper charts, they must be using the same datum.

7.3 Raymarine GPS / GNSS receiver compatibility

Raymarine GPS receivers and GNSS (GPS/GLONASS) receivers are compatible with the following GNSS and SBAS.

Status / Type	Name	Compatible receivers
Operational GNSS	GPS	All internal and external Raymarine GPS receivers and GNSS receivers
Operational GNSS	GLONASS	a9x and a12x internal GNSS receiver
Planned GNSS	COMPASS / Beidou-2	* a9x and a12x internal GNSS receiver
Planned GNSS	Galileo	* a9x and a12x internal GNSS receiver
Operational SBAS	WAAS	All internal and external Raymarine GPS receivers and GNSS receivers
Operational SBAS	EGNOS	All internal and external Raymarine GPS receivers and GNSS receivers
Operational SBAS	MSAS	All internal and external Raymarine GPS receivers and GNSS receivers
Operational SBAS	GAGAN	All internal and external Raymarine GPS receivers and GNSS receivers
Planned SBAS	QZSS	* a9x and a12x internal GNSS receiver

Note: * Not currently operational but will be supported via software update in the future.

7.4 Radar check



Warning: Radar scanner safety

Before rotating the radar scanner, ensure all personnel are clear.



Warning: Radar transmission safety

The radar scanner transmits electromagnetic energy. Ensure all personnel are clear of the scanner when the radar is transmitting.

Checking the radar

From the Radar application:

1. Select **Menu**.
2. Select **Power** so that On is highlighted.
The Radar scanner will now initialize in standby mode. This process will take approximately 70 seconds.
3. Select **Radar** so that Transmit is highlighted.
The radar scanner should now be transmitting and receiving.
4. Check that the radar screen is operating correctly.

Typical HD radar screen

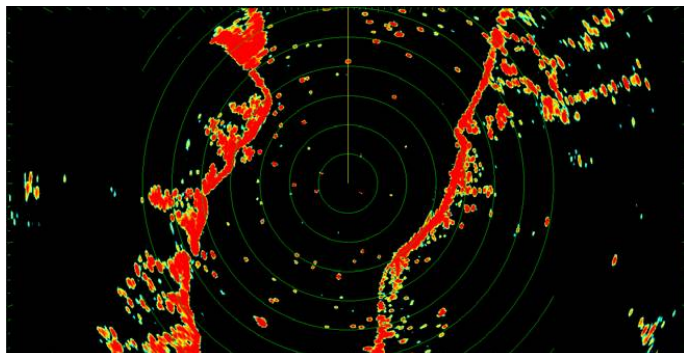

Note: The example above is representative of the enhanced output provided by a HD radar scanner.

Points to check:

- Radar sweep with echo responses are shown on screen.
- Radar status icon rotating in top right hand corner of the status bar.

Check and adjust bearing alignment

Bearing alignment

The radar bearing alignment ensures that radar objects appear at the correct bearing relative to your boat's bow. You should check the bearing alignment for any new installation.

Example misaligned radar

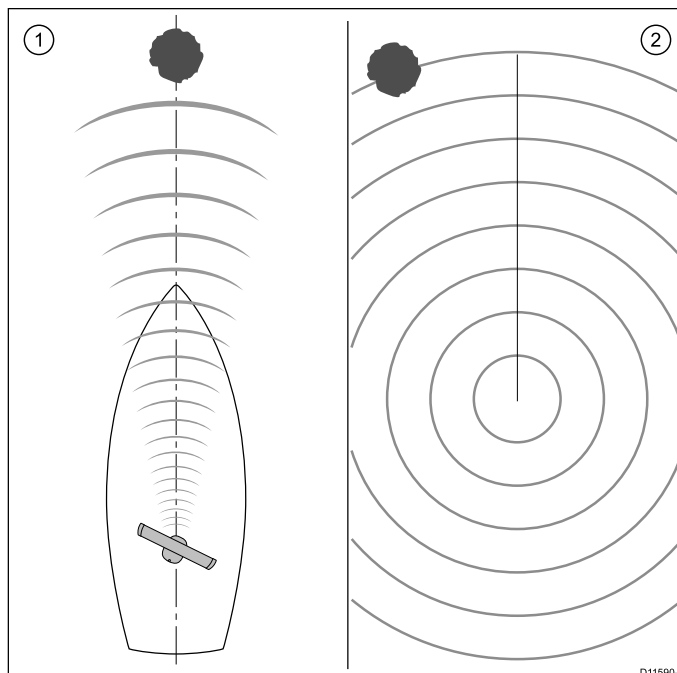

Item	Description
1	Target object (such as a buoy) dead ahead.
2	Target displayed on the radar display is not aligned with the Ship's Heading Marker (SHM). Bearing alignment is required.

Checking the bearing alignment

1. With your vessel under way: Align the bow with a stationary object identified on the radar display. An object between 1 & 2 NM distant is ideal.
2. Note the position of the object on the radar display. If the target is not under the ship's heading marker (SHM), there is an alignment error and you will need to carry out bearing alignment adjustment.

Adjusting the bearing alignment

Once you have checked the bearing alignment you can proceed and make any required adjustments.

With the radar application displayed:

1. Select **Menu**.
2. Select **Radar Set-up**.
3. Select **Advanced**.
4. Select **Bearing Alignment**.
Selecting Bearing Alignment displays the numeric adjust control.
5. Adjust the setting so that the selected target is under the Ship's Heading Marker.
6. Select **Back** or **Ok** when complete.

7.5 Sonar check

Sonar transducer and sonar module selection

You must select the sonar transducer and Sonar module that you want to use in the displayed Fishfinder application pane.

Sonar module selection

- Sonar and DownVision™ variant displays are fitted with an internal sonar module.
- All variants allow you to connect a compatible external sonar module or use an internal sonar module from a networked display.
- The sonar channel you want to use must be selected from the Fishfinder menu.

Transducer selection

- Sonar variant displays allow direct connection of a Raymarine OR a Minn Kota sonar transducer.
- DownVision™ variant displays allow direct connection of Raymarine DownVision™ transducers.
- All variants allow the connection of a Raymarine sonar transducer via a compatible external sonar module.
- For all variants use the **Transducer Set-Up** menu in the Fishfinder application to specify the transducer you want to use.

Selecting the sonar channel

To select the channel you want to display follow the steps below.

From the Fishfinder application:

1. Select **Menu**.
2. Select **Channel**.
The Channel selection page is displayed.
3. Select the tab for the sonar module you want to use.
A list of available channels for the selected sonar module is displayed.
4. Select a channel from the list.

The Channel selection page will close and the Fishfinder application will now show the selected channel.

Selecting the sonar transducer

With the fishfinder application displayed:

1. Select **Menu**.
2. Select **Set-Up**.
3. Select **Transducer Set-Up**.
4. Select **Transducer**.
A list of transducers is displayed.
5. Select the transducer you want to use.

Selecting the speed transducer

With the fishfinder application displayed:

1. Select **Menu**.

2. Select **Set-Up**.
3. Select **Transducer Set-Up**.
4. Select **Speed Transducer**.
A list of transducers is displayed.
5. Select your speed transducer from the list.

Checking the sonar

Sonar checks are made using the fishfinder application.

1. Select a fishfinder page from the Homescreen.

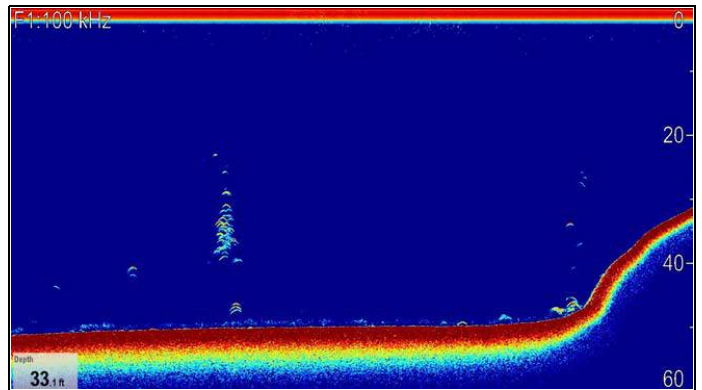

2. Check the fishfinder display.

With the fishfinder active you should see:

- Depth reading (indicates the transducer is working). The depth is shown in a databox in the bottom left of the screen.

If the databox is not present it can be turned on from the Presentation menu: **Menu > Presentation > Databoxes Set-up**.

Fishfinder Transducer Calibration

Your fishfinder transducer must be calibrated correctly to achieve accurate depth readings.

The multifunction display receives the image from a sonar module which processes sonar signals from a transducer mounted in the water. If the transducer is equipped with a speed paddle wheel and temperature-sensing thermistor, the sonar module calculates speed and temperature. To ensure accurate readings, it may be necessary to calibrate the transducer(s) by applying offsets to depth, speed and temperature. As these settings are held in the sonar module and relate to the transducer, they are applied system-wide.

Depth Offset

Depths are measured from the transducer to the sea bed, but you can apply an offset value to the depth data, so that the displayed depth reading represents the depth to the sea bed from either the keel or the waterline.

Before attempting to set a waterline or keel offset, find out the vertical separation between the transducer and either the waterline or the bottom of the keel on your vessel, as appropriate. Then set the appropriate depth offset value.

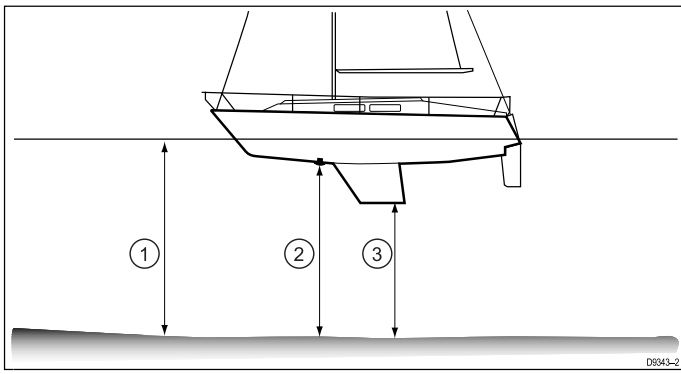

1	Waterline offset
2	Transducer / Zero offset
3	Keel offset

If an offset is not applied, displayed depth readings represent the distance from the transducer to the sea bed.

Setting the depth offset

From the fishfinder application:

1. Select **Menu**.
2. Select **Set-up**.
3. Select **Transducer Set-up**.
4. Select **Depth Offset**.

The depth offset numeric adjust control is displayed.

5. Adjust the offset to the required value.

Setting the speed offset

From the fishfinder application:

1. Select **Menu**.
2. Select **Set-up**.
3. Select **Transducer Set-up**.
4. Select **Speed Offset**.

The speed offset numeric adjust control is displayed.

5. Adjust the offset to the required value.

Setting the Temperature offset

1. Select **Menu**.
2. Select **Set-up**.
3. Select **Transducer Set-up**.
4. Select **Temperature Offset**.

The temperature offset numeric adjust control is displayed.

5. Adjust the offset to the required value.

7.6 Thermal camera setup and checks

To ensure correct operation of the thermal camera you should setup and check the camera's main functions.

Before proceeding ensure that the camera is connected correctly, according to the instructions provided. If your system includes the optional Joystick Control Unit (JCU) and PoE (Power over Ethernet) injector, ensure these units are also connected correctly.

Set up the camera

You will need to:

- Adjust the image (contrast, brightness, and so on).
- Check camera movement (pan, tilt and home functions) (if applicable).

Adjusting the thermal camera image

With the thermal camera application displayed:

1. Select **Menu**.
2. Select **Adjust Contrast**.
3. Select the Contrast, Brightness, or Color option as appropriate.
The relevant numeric adjust control is displayed.
4. Adjust the value as required.
5. Select **Back** or **Ok** to confirm the new value.

Pan, Tilt, Zoom (PTZ) cameras



Panning and tilting, and the thermal image

On a touchscreen multifunction display you can pan and tilt the thermal camera image using the touchscreen.

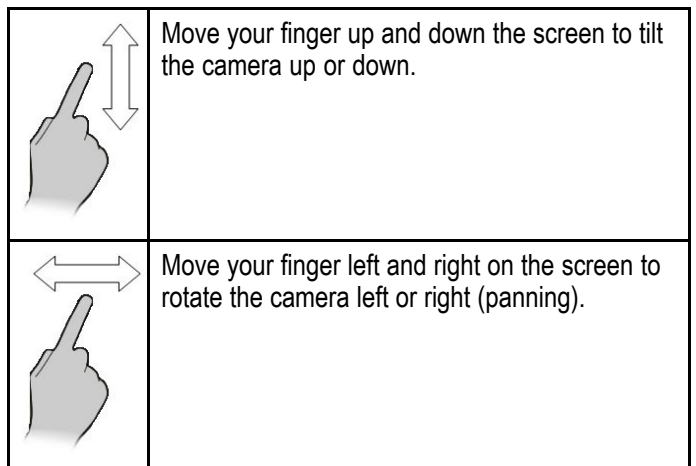

Panning, Tilting and zooming the thermal image

On a multifunction display with physical buttons or when using a remote keypad you can pan, tilt and zoom the thermal camera image using the UniControl.

In some circumstances it may be better to use just the UniControl's rotary and joystick controls to manipulate the thermal camera view. For example, this method is ideal for finer control over the camera and is particularly useful in rough sea conditions.

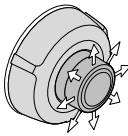
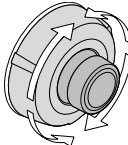
	UniControl joystick — is used for rotating the camera left or right (panning), or tilting the camera up or down.
	UniControl rotary — is used to zoom in and out.

Resetting the thermal camera to the home position

When connected to a pan, tilt thermal camera the home position of the camera can be set.

In the thermal camera application:

1. Select **Menu**.
2. Select **Camera Home**.

The camera returns to its currently defined home position, and the “Home” icon appears on-screen momentarily.

Chapter 8: Managing display data

Chapter contents

- 8.1 Memory cards and chart cards on page 112
- 8.2 Inserting a memory card or chart card on page 112
- 8.3 Removing a memory card or chart card on page 113
- 8.4 Saving user data and user settings on page 113
- 8.5 Save and restore items on page 116
- 8.6 Screenshots on page 118
- 8.7 Resetting your system on page 118

8.1 Memory cards and chart cards

MicroSD memory cards can be used to back up / archive data (e.g. Waypoint, and Tracks). Once data is backed up to a memory card old data can be deleted from the system, creating capacity for new data. The archived data can be retrieved at any time. Chart cards provide additional or upgraded cartography.

It is recommended that your data is backed up to a memory card on a regular basis. Do NOT save data to a memory card containing cartography.

Compatible cards

The following types of MicroSD cards are compatible with your display:

- Micro Secure Digital Standard-Capacity (MicroSDSC)
- Micro Secure Digital High-Capacity (MicroSDHC)

Note:

- The maximum supported memory card capacity is 32 GB.
- MicroSD cards must be formatted to use either the FAT or FAT 32 file system format to enable use with your MFD.

Speed class rating

For best performance it is recommended that you use Class 10 or UHS (Ultra High Speed) class memory cards.

Chart cards

Your product is pre-loaded with electronic charts (worldwide base map). If you wish to use different chart data, you can insert compatible chart cards into the unit's memory card reader.

Use branded chart cards and memory cards

When archiving data or creating an electronic chart card, Raymarine recommends the use of quality branded memory cards. Some brands of memory card may not work in your unit. Please contact customer support for a list of recommended cards.

8.2 Inserting a memory card or chart card

1. Open the card reader door.
2. Insert the card, as shown in the diagram below. For slot 1, the card contacts should be facing DOWN. For slot 2, the card contacts should be facing UP. Do NOT force the card. If the card does not fit easily into the slot, check the orientation.

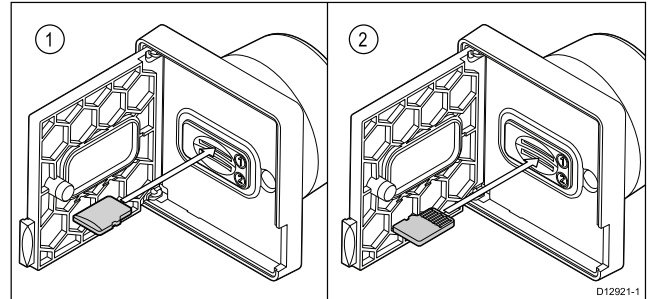

3. Gently press the card all the way in to the card slot, as shown in the diagram below. The card is secure when an audible click is heard.

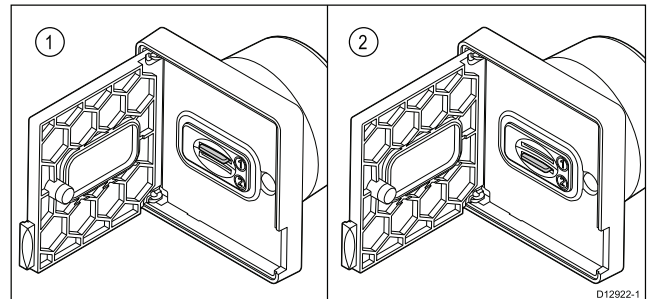

4. To prevent the ingress of water and consequent damage, close the card reader door.

8.3 Removing a memory card or chart card

From the homescreen:

1. Select **My Data**.
2. Select **Eject Card**.
A message is displayed prompting you to select the memory device you want to eject.
3. Select **SD1** for a memory card in the top card slot, or **SD2** for a memory card in the bottom card slot.
4. Open the card reader door.
5. Push the edge of the card towards the unit, until an audible click is heard.

The card is released from the card slot mechanism, as shown in the following diagram:

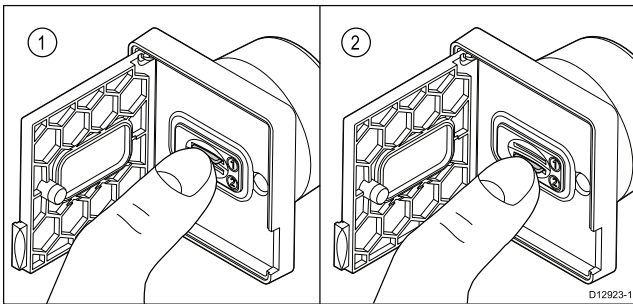

6. Use your fingers to pull the card clear of the card slot, using the edge of the card.

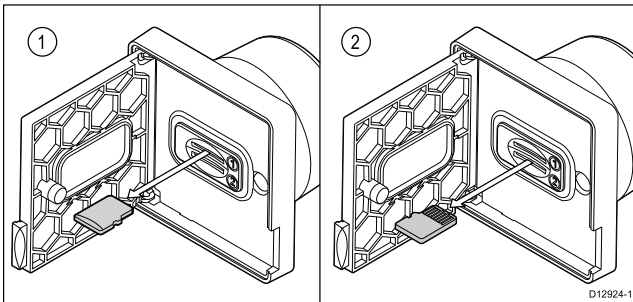

7. To prevent the ingress of water and consequent damage, close the chart card door.

Note: You can also power off the multifunction display and follow steps 4 to 7 above.

8.4 Saving user data and user settings

You can save your waypoints, routes, tracks and user settings to a memory card. Waypoints, routes and tracks are saved as gpx data files. The gpx file format is a device-independent data format making it easy to exchange data between your display and other GPS devices / software that support the gpx file format.

Type of data	Description	Notes
Waypoints (user data)	Each waypoint group can be saved separately	
Routes (user data)	Each route can be saved separately	
Tracks (user data)	Each track can be saved separately	
User settings	Saves the settings you've made in the set-up menus to a single archive file.	Only 1 user settings archive file can be saved per memory card.

Note: It is recommended that you save your user data and user settings to a memory card on a regular basis.

Note: Do NOT save user data or settings to a chart card containing cartography.

Saving all user data to a memory card

You can save all user data to one archive file.

With the Homescreen displayed:

1. Ensure you have a memory card (NOT a chart card) inserted into a card slot.
2. Select **My Data**.
3. Select **Import/Export**.
4. Select **Save Data to Card**.
5. Select **Save All**.
The on-screen keyboard is displayed.
6. Using the on-screen keyboard enter the filename you want to save the file as.
7. Select **SAVE**.
If your display has more than 1 card slot then a message is displayed prompting you to select the slot you want to save data to, if your display only has 1 card slot then you will not be prompted.
8. Select **SD1** for a memory card in the top card slot, or **SD2** for a memory card in the bottom card slot.
A confirmation dialog is displayed.
9. Select **OK**.

Saving waypoints to a memory card

With the Homescreen displayed:

1. Ensure you have a memory card (NOT a chart card) inserted into a card slot.
2. Select **My Data**.
3. Select **Import/Export**.
4. Select **Save Data to Card**.

5. Select **Save Waypoints to Card**.

The Waypoint Group list is displayed.

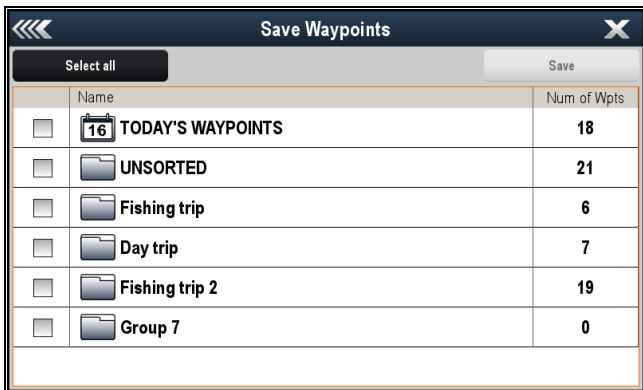

6. Select the group or groups you want to save, or select **Select All**.

7. Select **Save**.

The on-screen keyboard is displayed.

8. Using the on-screen keyboard enter the filename you want to save the file as.

9. Select **SAVE**.

If your display has more than 1 card slot then a message is displayed prompting you to select the slot you want to save data to, if your display only has 1 card slot then you will not be prompted.

10. Select **SD1** for a memory card in the top card slot, or **SD2** for a memory card in the bottom card slot.

A confirmation dialog is displayed.

11. Select **OK**.

Saving routes to a memory card

With the Homescreen displayed:

1. Ensure you have a memory card (NOT a chart card) inserted into a card slot.

2. Select **My Data**.

3. Select **Import/Export**.

4. Select **Save Data to Card**.

5. Select **Save Routes to Card**.

The Routes list is displayed.



6. Select the route or routes you want to save, or select **Select All**.

7. Select **Save**.

The on-screen keyboard is displayed.

8. Using the on-screen keyboard enter the filename you want to save the file as.

9. Select **SAVE**.

If your display has more than 1 card slot then a message is displayed prompting you to select the

slot you want to save data to, if your display only has 1 card slot then you will not be prompted.

10. Select **SD1** for a memory card in the top card slot, or **SD2** for a memory card in the bottom card slot.

A confirmation dialog is displayed.

11. Select **OK**.

Saving tracks to a memory card

With the Homescreen displayed:

1. Ensure you have a memory card (NOT a chart card) inserted into a card slot.

2. Select **My Data**.

3. Select **Import/Export**.

4. Select **Save Data to Card**.

5. Select **Save Tracks to Card**.

The Tracks list is displayed.

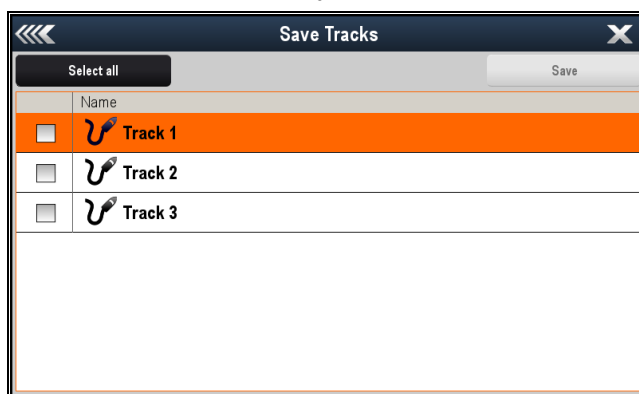

6. Select the track or tracks you want to save, or select **Select All**.

7. Select **Save**.

The on-screen keyboard is displayed.

8. Using the on-screen keyboard enter the filename you want to save the file as.

9. Select **SAVE**.

If your display has more than 1 card slot then a message is displayed prompting you to select the slot you want to save data to, if your display only has 1 card slot then you will not be prompted.

10. Select **SD1** for a memory card in the top card slot, or **SD2** for a memory card in the bottom card slot.

A confirmation dialog is displayed.

11. Select **OK**.

Importing waypoints, routes, or tracks from a memory card

With the Homescreen displayed:

1. Ensure you have a memory card containing the user data in gpx format in one of the card slots.

2. Select **My Data**.

3. Select **Import/Export**.

4. Select **Retrieve from Card**.

The file browser is opened.

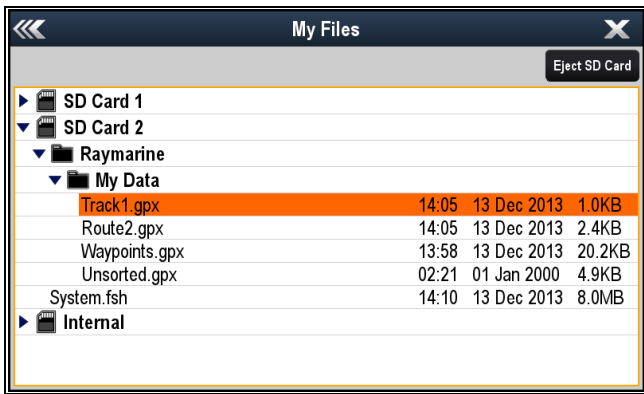

5. Browse to and select the file you want to import. A confirmation dialog is displayed.
6. Select **OK**.

Note: When Routes and Tracks are imported they will be hidden by default, to display the imported routes and tracks please refer to the [Showing or hiding routes and tracks](#) section.

Erasing user data files from a memory card

With the Homescreen displayed:

1. Ensure you have the memory card containing the data in one of the card slots.
2. Select **My Data**.
3. Select **Import/Export**.
4. Select **Erase from Card**.
The file browser is opened.

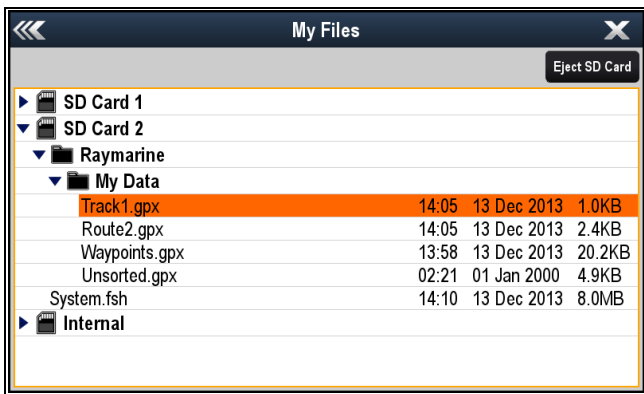

5. Browse to and select the file you want to erase. A confirmation dialog is displayed.
6. Select **Yes**.

Erasing waypoints, routes, and tracks from the system

Note: The following procedure permanently erases selected or ALL waypoints, routes, or tracks stored on the display. BEFORE proceeding, ensure that you backup any data that you want to keep on to a memory card.

With the Homescreen displayed:

1. Select **My Data**.
2. Select **Import/Export**.
3. Select **Erase from System**.
4. Select **Erase Waypoints from System, Erase Routes from System, or Erase Tracks from System**, as appropriate.

5. Select the specific data items you want to erase, or select **Erase All**.

A message is displayed prompting you for confirmation.

6. Select **Yes** to proceed with the deletion, or **No** to cancel the operation.

Backing up user settings to a memory card

With the Homescreen displayed:

1. Ensure you have a memory card (NOT a chart card) in one of the card slots.
2. Select **My Data**.
3. Select **Import/Export**.
4. Select **Backup Settings**.

If your display has more than 1 card slot then a message is displayed prompting you to select the memory device you want to save the settings to, if your display only has 1 card slot then you will not be prompted.

5. Select **SD1** for a memory card in the top card slot, or **SD2** for a memory card in the bottom card slot. A confirmation dialog is displayed.
6. Select **OK**.

Restoring user settings from a memory card

With the Homescreen displayed:

1. Ensure you have the memory card containing the user data in one of the card slots.
2. Select **My Data**.
3. Select **Import/Export**.
4. Select **Restore Settings**.

If your display has more than 1 card slot then a message is displayed prompting you to select the memory device you want to retrieve settings from, if your display only has 1 card slot then you will not be prompted.

5. Select **SD1** for a memory card in the top card slot, or **SD2** for a memory card in the bottom card slot. A confirmation dialog is displayed.
6. Select **OK**.

8.5 Save and restore items

The table below details the data items and settings which will be saved to and restored from a memory card on your multifunction display.

Homescreen and settings

Menu	Setting
Homescreen	Default page configuration
Set-up > System settings	Autopilot control
	DSC alerts
Set-up > System settings > GPS Set-up	GPS screen
Set-up > System settings > External Devices > AIS Unit Set-up	Silent mode
	AIS safety messages
Set-up > System settings > External Devices > Remote control	Shortcut key
Set-up > System settings > External Devices > Weather Set-up	Source
Set-up > System settings > External Devices > Engines Set-up	Number of engines
Set-up > System settings > System preferences	Bearing mode
	Variation source
	Manual variation
	System Datum
Set-up > System settings	Simulator
Customize	Language
Customize > Boat Details	Boat Type
	Number of Engines
	Number of Fuel Tanks
	Number of Batteries
Customize > Units Set-up	Distance units
	Speed Units
	Depth Units
	Temperature Units
	Pressure Units
	Volume Units
	Economy Units
	Wind Speed Units
Customize > Time and Date Set-up	Date format
	Time format
	Local time offset

Menu	Setting
Customize > Databar Set-up	Databar content (cell 1 to 6)
	Compass in titlebar
	Status Icon Bar
	Databar Autohide
Customize > Display Preferences	Starting Page
	Key Beep
	Color Theme
	Cursor Autohide
	Range Controls
	Chart Ctxt Menu
	Pilot Control Bar
	Screenshot File

Alarm Manager

Menu	Setting
Safety Alarms	Waypoint arrival
	Offtrack alarm
	Anchor alarm
	Low fuel remaining
	MOB Data type
	Safezone (AIS targets)
General Alarms	Alarm clock
	Countdown timer
	Water temperature
General Alarms > Fish alarm	Enable
	Fish alarm depth limits
	Fish alarm shallow limit
	Fish alarm deep limit

Chart application

Menu	Setting
Presentation	Chart Display
Presentation > Overlays	Aerial overlay
	Chart grid
	2D shading
	Community edits
	Chart text
	Chart boundaries
	Boat size
	Databox 1
	Databox 1 content
	Databox 2

Menu	Setting
	Databox 2 content
Presentation > Vectors	Vector length
	Vector width
Presentation > Objects	Show rocks
	Nav marks
	Nav marks symbols
	Light sectors
	Routing systems
	Caution areas
	Marine features
	Land features
	Business services
	Panoramic photos
	Roads
	Additional wrecks
	Colored seabed areas
	Vessel icon
Presentation > Depth & Contours	Show soundings
	Show contours
	Shallow contour
	Safety contour
	Depth contour
	Deep water color

Menu	Setting
	Dial color
	Number of engines
	Maximum RPM range

Weather application

Menu	Setting
Databoxes Set-up	Databox 1
	Databox 1 content
	Databox 2
	Databox 2 content

Radar application

Menu	Setting
Presentation	Range rings
Presentation > Databoxes	Databox 1
	Databox 1 content
	Databox 2
	Databox 2 content

Fishfinder application

Menu	Setting
Channel	Channels
Presentation > Databoxes Set-up	Databox 1
	Databox 1 content
	Databox 2
	Databox 2 content

Data application

Menu	Setting
	Datapages and content
Presentation	Color theme

8.6 Screenshots

You can take a screenshot of what is currently displayed on the screen.

Screenshots are saved to a MicroSD card in .bmp (bitmap) format. The saved image can be viewed from any device capable of viewing bitmap images.

Taking a screenshot

You can take a screenshot by following the steps below.

1. Insert a MicroSD card with suitable free space available into the card reader.
2. Press the **Power** button.
The Shortcuts page is displayed:
3. Select the **Camera** icon.
A confirmation message is displayed.
4. Select **Ok**.
The screenshot is now saved to the MicroSD card.

Tip If your multifunction display has a **Back** button you can also take a screenshot by pressing and holding the **Back** button until the confirmation message appears.

Selecting the SD card slot for screenshots

If your multifunction display has 2 card reader slots, you must select which card slot to save the screenshot to.

From the homescreen.

1. Select **Customize**.
2. Select **Display Preferences**.
3. Select **Screenshot File:**.
4. Select either **MicroSD 1** or **MicroSD 2**.

Viewing a screenshot on the multifunction display

You can view images on the multifunction display.

1. Insert a MicroSD card containing the screenshot or image into the MicroSD card slot of your multifunction display.
2. From the homescreen, select **My Data**.
3. Select **Images and Video**.
The file browser dialog is displayed.
4. Use the file browser to locate the file on the MicroSD card.
5. Select the file you want to view.
The file will now open.
6. Select **Back** or **Close** to close the image.

8.7 Resetting your system

Your system may be reset to its factory default settings if required.

There are 2 types of reset operation, both of which affect the current display you are using, AND any networked displays.

- Settings reset.
- Settings and data reset.

Settings reset

This option resets your setup menus, page sets, and databar settings to factory default. It will NOT affect your waypoints, routes, or tracks data.

Settings and data reset

In addition to the settings reset detailed above, performing a settings and data reset will also remove ALL waypoints, routes, and tracks data.

Resetting system settings

With the homescreen displayed:

1. Select **Set-up**.
2. Select **Maintenance**.
3. Select **System Settings Reset**.
A message is displayed prompting you to confirm the action.
4. Select **Yes** to proceed with the settings reset, or **No** to cancel.

Resetting system settings and data

<p>Note: Performing a settings and data reset erases ALL waypoints, routes, and track data from your system. BEFORE proceeding with a settings and data reset, ensure that you backup any data that you want to keep on to a memory card.</p>
--

With the homescreen displayed:

1. Select **Set-up**.
2. Select **Maintenance**.
3. Select **System Settings and Data Reset**.
A message is displayed prompting you to confirm the action.
4. Select **Yes** to proceed with the settings and data reset, or **No** to cancel.

Chapter 9: Customizing your display

Chapter contents

- [9.1 Language selection on page 120](#)
- [9.2 Boat details on page 121](#)
- [9.3 Units set-up on page 122](#)
- [9.4 Time and Date set-up on page 123](#)
- [9.5 Display preferences on page 124](#)
- [9.6 Databar and databox overview on page 127](#)
- [9.7 List of data items on page 129](#)
- [9.8 System set-up menus on page 136](#)

9.1 Language selection

The system can operate in the following languages:

English (US)	English (UK)	Arabic
Bulgarian	Chinese	Croatian
Czech	Danish	Dutch
Finnish	French	German
Greek	Hebrew	Icelandic
Italian	Japanese	Korean
Norwegian	Polish	Portuguese (Brazilian)
Russian	Slovenian	Spanish
Swedish	Turkish	

With the Homescreen displayed:

1. Select **Customize**.
2. Select **Language**.
3. Select your language from the list of languages.

Language is part of the Shared Preferences scheme. Once a new language is selected the User interface language will change on all MFDs networked using **SeaTalk^{hs}** or **SeaTalk^{ng}** and any instrument displays networked using **SeaTalk^{ng}** .

9.2 Boat details

You can customize various settings to make them specific to your vessel.

Menu item	Description	Options
Boat Type	<p>You can change the appearance of the vessel in the chart application. Select the option that most closely resembles the type and size of your vessel.</p> <div style="border: 1px solid black; padding: 5px; margin: 10px 0;"> <p>Note: When boat type is selected during the initial set up of the multifunction display the boat type shall determine the datapage configuration in the data application.</p> </div>	<ul style="list-style-type: none"> • Power Cruiser 1 (default) • Power Cruiser 2 • Power Cruiser 3 • Inboard Speed Boat • Outboard Speed Boat • Workboat • RIB • Sail Cruiser • Race Sail • Catamaran • Sport Fishing • Pro Fishing
Min. Safe Depth	The Minimum Safe Depth setting is required when building routes using the Autorouting feature.	• 1.0 to 50.0.
Num. of Engines	Allows you to specify the number of engines your vessel has. This setting determines the number of engines shown in the engine data application.	• 1 to 5
Num. of Fuel Tanks	Allows you to specify the number of fuel tanks your vessel has. This setting determines the number of fuel tanks available in the Data application.	• 1 to 5
Num. of Batteries	Allows you to specify the number of batteries your vessel has. This setting determines the number of batteries available in the Data application.	• 1 to 16
Total Fuel Capacity	Allows you to specify the total fuel capacity of your vessel, this is required in order to enable the fuel manager function.	• 0 to 9999 units.

Customizing the vessel icon

With the homescreen displayed:

1. Select **Customize**.
2. Select **Boat Details**.
3. Select **Boat Type**.
4. Select the icon that most closely resembles your vessel type and size.

9.3 Units set-up

You can specify your preference for the units of measurement that will be used in all applications.

Menu item	Description	Options
Distance Units	The units of measure that will be used in all applications for the display of all values related to distance.	<ul style="list-style-type: none"> • Nautical Miles • NM & m (major units = Nautical Miles, minor units = meters) • Statute Miles • Kilometers
Speed Units	The units of measure that will be used in all applications for the display of all values related to speed.	<ul style="list-style-type: none"> • Knots • MPH (Miles Per Hour) • KPH (Kilometers Per Hour)
Depth Units	The units of measure that will be used in all applications for the display of all values related to depth.	<ul style="list-style-type: none"> • Feet • Meters • Fathoms
Temperature Units	The units of measure that will be used in all applications for the display of all values related to temperature.	<ul style="list-style-type: none"> • Fahrenheit • Celsius
Pressure Units	The units of measure that will be used in all applications for the display of all values related to pressure.	<ul style="list-style-type: none"> • Bar • PSI • Kilopascals
Volume Units	The units of measure that will be used in all applications for the display of all values related to volume.	<ul style="list-style-type: none"> • US Gallons • Imperial Gallons • Liters
Economy Units	The units of measure that will be used in all applications for the display of all values related to fuel usage.	<ul style="list-style-type: none"> • Distance per Volume • Volume per Distance • Liters per 100 km
Wind Speed Units	The units of measure that will be used in all applications for the display of all values related to wind speed.	<ul style="list-style-type: none"> • Knots • Metres per second

Specifying preferred units of measurement

1. Select **Customize**.
2. Select **Units Set-up**.
3. Select the type of measurement you want to change (for example, Distance Units).
4. Select the preferred type of unit (for example, Statute Miles).

9.4 Time and Date set-up

You can specify your preference for the way that time and date will appear in all applications.

Menu item	Description	Options
Date Format	Allows you to specify the preferred format for the display of date information in all applications.	<ul style="list-style-type: none">• MM:DD:YY (Month, Day, Year)• DD:MM:YY (Day, Month, Year)
Time Format	Allows you to specify the preferred format for the display of time information in all applications.	<ul style="list-style-type: none">• 12hr• 24hr
Local Time: UTC	Allows you to specify the local time zone that will be used, in terms of an offset from UTC (Universal Coordinated Time), in 0.5 hour increments.	<ul style="list-style-type: none">• -13 to +13 hours (in 0.5 hour increments)

9.5 Display preferences

You can specify your preference for general display behavior.

Menu item	Description	Options
Starting page	Allows you to select what page the display opens at start up.	<ul style="list-style-type: none"> • Homescreen (default) • Last page — After power up the last used page is displayed. • Choose page — After power up the page selected is displayed.
Key Beep	An audible sound can be made each time a button is pressed or the touchscreen is used.	<ul style="list-style-type: none"> • ON (default) • OFF
Cursor Autohide	If set to On, the cursor will be automatically hidden after a period of no movement. If set to Off, the cursor will persist on the screen until moved.	<ul style="list-style-type: none"> • ON • OFF (default)
Range Controls	<p>On New e Series and gS Series displays you can specify whether the Chart, Radar and Weather application display the onscreen range in and range out icons.</p> <div style="border: 1px solid black; padding: 5px;"> <p>Note:</p> <ul style="list-style-type: none"> • Onscreen range controls are not available on non-touchscreen displays. • Onscreen range controls cannot be hidden on touch only displays. </div>	<ul style="list-style-type: none"> • Show (default) • Hide
Context Menu	(Touchscreen displays only) Determines how the context menu is accessed using touch	<ul style="list-style-type: none"> • Touch (default) — touching a chart object opens the context menu. • Hold — Touch and holding on a chart object opens the context menu.
Pilot Control Bar	<p>Allows you to enable and disable the pilot bar on each display individually, when connected to an SPX or SeaTalk autopilot.</p> <div style="border: 1px solid black; padding: 5px;"> <p>Note: For evolution autopilots the Pilot Bar option is in the Pilot Set-up page.</p> </div>	<ul style="list-style-type: none"> • Shown • Hidden
Shared Brightness	You can set up shared brightness groups (or “zones”) to adjust the brightness on multiple units simultaneously.	<p>Share Brightness</p> <ul style="list-style-type: none"> • ON (default) • OFF <p>Brightness Group</p> <ul style="list-style-type: none"> • Helm 1 (default) • Helm 2 • Cockpit • Flybridge • Mast • Group 1 • Group 2 • Group 3 • Group 4 • Group 5
Screenshot File	Enables you to specify the default memory card slot for screen capture images.	<ul style="list-style-type: none"> • MicroSD 1

Menu item	Description	Options
	Note: This option is only available on displays with multiple card reader slots.	<ul style="list-style-type: none"> • MicroSD 2

Onscreen range controls

You can enable and disable onscreen range controls on New e Series and gS Series displays by following the steps below.

From the homescreen:

1. Select **Customize**.
2. Select **Display Preferences**.
3. Select **Range Controls**.

Selecting Range Controls will switch between showing and hiding the onscreen range controls.

Shared brightness

You can set up shared brightness groups to adjust the brightness on multiple units simultaneously.

The following units are compatible with shared brightness groups:

- a Series
- c Series
- e Series
- gS Series
- i50
- i60
- i70
- p70 / p70R pilot controllers
- ST70
- ST70+

Once compatible units are added to a shared brightness group, any brightness adjustment made to any of the units in the group is also reflected in all other units in that group. An on-screen single brightness control is available for controlling any units in the brightness group:

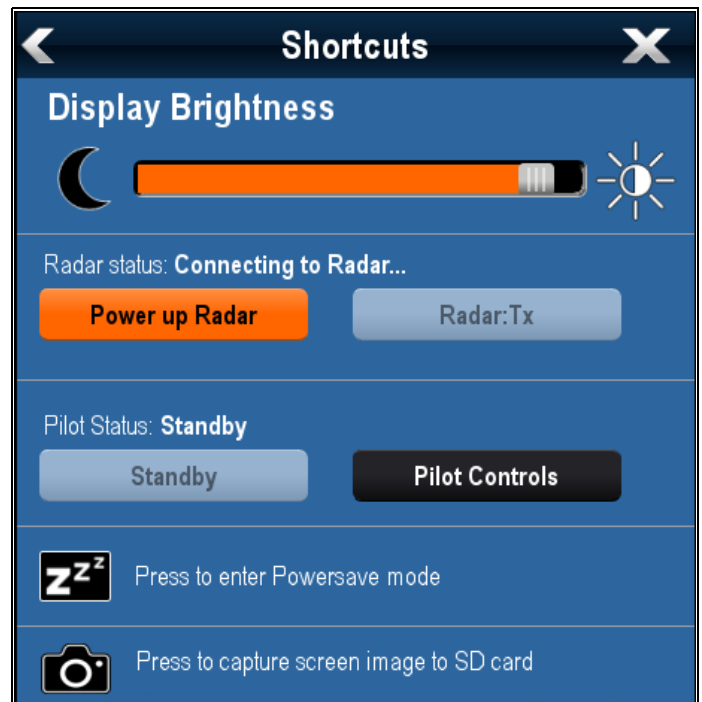

Multiple brightness groups can be configured. This can reflect the physical location of the units on your vessel if required. For example, the units at your helm can be set to one group, and the units on the flybridge can be set to a different group. In this example, any brightness adjustments made to a unit at the helm would be automatically reflected in the other units at the helm but not on the flybridge.

The shared brightness function requires the following:

- All units must be compatible with the shared brightness function (see list of compatible units above).
- Before a unit can respond to a shared brightness adjustment it must be assigned to the relevant **Brightness Group**.
- A single unit can only belong to one brightness group at any one time.
- The **Share brightness** setting must be set to On for all units in the brightness group.
- When setting up a brightness group an initial **Sync brightness** operation must be performed, with all the displays in that group powered on, to configure the display brightness of all units in the group.

Setting up shared brightness

With the homescreen displayed:

1. Select **Customize**.
2. Select **Display Preferences**.
3. Select **Shared Brightness**.
4. Select the On option for the **Shared brightness** menu item.
5. Select **Brightness Group**.

6. Select an appropriate brightness group.
7. Repeat the process for the other displays you want in the brightness group. If the display is not a multifunction display, refer to the documentation that accompanies the unit for instructions on setting-up shared brightness.
8. Once all required displays have been added to the same brightness group, select **Sync Brightness** on the multifunction display.
A shared brightness message is displayed.
9. Ensure all displays in the brightness group are powered on.
10. Select **Sync**.
When completed a message is displayed confirming that shared brightness has been configured.

Once shared brightness has been successfully configured, changing the brightness of any display in that brightness group will automatically change the brightness of all displays in that group.

9.6 Datarbar and databox overview

You can customize the data displayed in the datarbar and onscreen databoxes.

Customizable data is displayed in the datarbar, extended datarbar (HybridTouch displays only) or databoxes. The datarbar, extended datarbar and databoxes are available in all applications.

These areas of the screen are illustrated and described below:

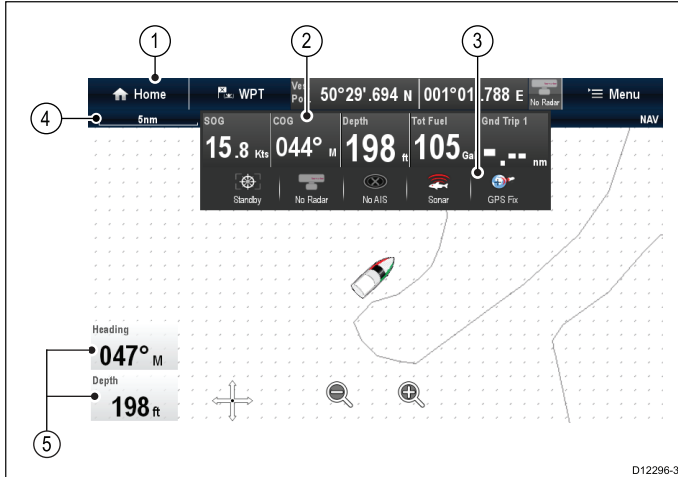

1. **Datarbar** — displayed at the top of the screen in all applications. The datarbar contains cells that can be customized to display data from a wide range of categories. The datarbar can also be hidden to provide
2. **Expanded Datarbar** — (Touchscreen displays only) displayed when you touch the datarbar. The extended datarbar can be displayed. The expanded datarbar is displayed until the screen is touched again.
3. **Status icons** — You can display the status icons below the expanded datarbar. This provides status information for externally connected equipment:
4. **Status Bar** — Permanently displayed in all applications. The status bar contains information on the currently selected settings of the application displayed onscreen.
5. **Databoxes** — up to 2 databoxes can be displayed. Each box can display one item of data from the available data categories. Data is permanently displayed onscreen.

The datarbar can be set to auto-hide so that only the Status bar is visible onscreen.



Auto-hide the datarbar

On multifunction displays that have a touchscreen, the datarbar that is displayed at the top of all applications pages can be set to auto-hide. This provides a larger screen area for the application pages.

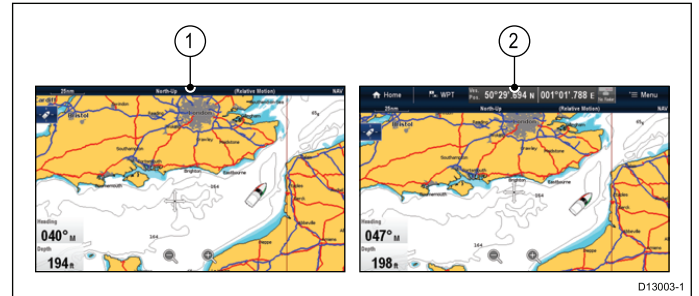

From the Homescreen:

1. Select **Customize**.
2. Select **Datarbar Set-up**.
3. Select **Auto-Hide** so that On is selected.

When viewing application pages the datarbar will now auto-hide after 10 seconds. You can view the datarbar again by touching the datarbar with your finger.

Customizing databoxes in the chart application

To switch databoxes on and off and to select data to display follow the steps below.

From the Chart application menu:

1. Select **Presentation**.
2. Select **Overlay**.
3. Select **Databoxes**.
4. Select **Databox 1 > On**.
5. Select **Databox 2 > On**.
6. Choose the **Select Data** option for the relevant databox.
7. Select the category that reflects the type of data you want to display in the databox. For example, Depth data.
8. Select the data item.
The data you selected is displayed onscreen in the appropriate databox.

Customizing Databoxes

In the Radar, Fishfinder, or Weather application:

1. Select **Menu**.
2. Select **Presentation**.
3. Select **Databoxes**.
4. Select **Databox 1 > ON**.
5. Select **Databox 2 > ON**.
6. Choose the **Select Databox 1** or **Select Databox 2** menu item, as appropriate.
7. Select the category that reflects the type of data you want to display in the databox. For example, Depth data.
8. Select the data item.
The data you selected is displayed onscreen in the appropriate databox.

Customizing the databar

From the homescreen:

1. Select **Customize**.
2. Select **Databar Set-up**.
3. Select **Edit Databar**.
4. In the databar, select the cell that you want to change.
The Select Data Category menu will be displayed.
5. Select the category that reflects the type of data you want to display in the cell. For example, Depth data.
6. Select the data item.
The data you selected is displayed on-screen in the appropriate cell.
7. Select **Home** or **Back** when completed.

Displaying status icons in the databar

Touchscreen multifunction displays enable you to display status icons in the databar.

From the homescreen:















































1. Select **Customize**.
2. Select **Databar Set-up**.
3. Select **Status Icon Bar** so that On is highlighted.
The status icons are now displayed below the expanded databar.



































9.7 List of data items





























Categories of data available to display in the data application, databoxes, databar, and expanded databar are shown below. Dial graphics are not available in databoxes or databars.





































The following table shows the data items available by category.



































Data Category	Description	Data Item	Data application Graphics			
Battery**	Battery status	Battery Amps				
		Battery Temperature				
		Battery Voltage				
		Battery Charge				
Boat	Types of data generated by your vessel. For example, tank levels.	Rate of Turn				
		Heel Angle				
		Trim Tabs (Data application only.)				
Depth	Depth data.	Depth				
		Maximum Depth				
		Minimum Depth				
Distance	Types of data related to distance travelled by your vessel. For example, trip distance.	Log & Trip				
		Log				
		Trip				
		Ground Log and Trip				
		Ground Log				
		Ground Trip 1				
		Ground Trip 2				
		Ground Trip 3				
Ground Trip 4						

















Data Category	Description	Data Item	Data application Graphics			
Engine**	Types of data generated by engines. For example, oil pressure.	RPM				
		RPM & SOG				
		Coolant Temperature				
		Coolant Pressure				
		Oil Temperature				
		Oil Pressure				
		Oil Pressure & Coolant Temperature				
		Transmission Oil Temperature				
		Transmission Oil Pressure				
		Transmission Gear				
		Boost Pressure				
		Fuel Pressure				
		Fuel Flow Rate				
		Fuel Flow (Inst)				
		Fuel Flow (Avg)				
		Engine Hours				
		Engine Trim				
		Alternator				
Engine Load						

Data Category	Description	Data Item	Data application Graphics			
Fuel**	Types of data related to the fuel system. For example, fuel levels.	Fuel Level (%)				
		Total Fuel (%)				
		Total Fuel (vol)				
		Fuel Flow Total				
		Economy				
		Estimated Fuel Remaining				
		Distance to Empty				
		Time to Empty				
		Fuel Used (Trip)				
		Fuel Used (Season)				
Environment	Environmental-related data. For example, air temperature.	Pressure				
		Air Temperature				
		Minimum Air Temperature				
		Maximum Air Temperature				
		Drift				
		Set				
		Set & Drift				
		Apparent Wind Chill				
		True Wind Chill				
		Humidity				
		Dew Point				
		Sunset / Sunrise				
Water Temperature						

Data Category	Description	Data Item	Data application Graphics			
		Minimum Water Temperature				
		Maximum Water Temperature				
GPS	GPS-related data. For example, vessel position.	Vessel Position				
		COG & SOG				
		COG				
		SOG				
		Maximum SOG				
		Average SOG				
Heading	Heading-related data. For example, locked heading.	Heading				
		Heading and Speed (Data application only.)				
		Locked Heading				
		Locked Heading Error				
		LH Error and LH (Data application only.)				
		Tack Heading				
		Compass (Data application only.)				
Navigation	Types of data related to navigation. For example, bearing to waypoint.	Cursor Position (Only available in the Databar and data overlay.)				
		Cursor info (Only available in the Databar and data overlay.)				
		Cross Track Error				
		Rolling Road (Data application only.)				

Data Category	Description	Data Item	Data application Graphics			
		Waypoint Info				
		Active Waypoint Name				
		Target Position				
		Bearing to Waypoint				
		BTW & DTW (Data application only.)				
		Course Made Good				
		CMG & DMG				
		CMG & VMG (Data application only.)				
		Distance to Waypoint				
		Distance Made Good				
		Waypoint ETA				
		Waypoint TTG				
		Route ETA				
		Route TTG				
Pilot	Pilot-related data. For example, rudder.	Rudder Angle				
Speed	Speed-related data. For example, VMG (Velocity Made Good) to Waypoint.	Speed				
		Maximum Speed				
		Average Speed				
		Speed and SOG				
		VMG to Windward				
		VMG to Waypoint				

Data Category	Description	Data Item	Data application Graphics			
Tanks**	Data related to water tanks	Fresh Water (%)				
		Grey Water (%)				
		Black Water (%)				
		Live Well (%)				
Time	Time-related data. For example, local time.	Local Time				
		Local Date				
Wind	Wind-related data. For example, VMG (Velocity Made Good) to Windward.	AWA				
		Maximum AWA				
		Minimum AWA				
		AWS				
		Maximum AWS				
		Minimum AWS				
		TWA				
		Maximum TWA				
		Minimum TWA				
		TWS				
		Maximum TWS				
		Minimum TWS				
		TWD				
		Cardinal Wind				
		Ground Wind				
Beaufort						
AWA and TWA						

Data Category	Description	Data Item	Data application Graphics			
		AWA & AWS				
		AWA (CH) and AWS				
		AWA and VMG				
		TWA & TWS				
		TWA (CH) and TWS				
		TWA and VMG				
		GWD and Beaufort				
		GWD & GWS				
None						

Note: *Dials and graphical representations are only available from the Data application. Databar and data cell overlays can only display digital items.

Note: **The Battery, Engine, Fuel and Tanks menus will display 1 set of data items per configured device (e.g. if the system has been configured with 3 engines then 3 sets of engine data items will be displayed).

9.8 System set-up menus

The system set-up menus enable you to configure your display and connected external devices.

The following menus are available:

Menu item	Description	Notes
Touch-Lock	<p>Enables you to lock the touchscreen of a touch only display when the display is paired with a remote keypad.</p> <div style="border: 1px solid black; padding: 2px; margin-bottom: 5px;"> <p>Note: This option is not available on touch-only displays which do not have a remote keypad connected.</p> </div> <div style="border: 1px solid black; padding: 2px;"> <p>Note: This option is not available on displays which have physical buttons.</p> </div>	<ul style="list-style-type: none"> • ON • OFF (default)
Alarms	Display the Alarm Manager. Refer to Chapter 12 Alarm management	
Fuel Manager	Displays the Fuel manager page	
Pilot Controls	Displays the Pilot Control dialog.	Only available when a Raymarine autopilot is detected on the system and Autopilot Control is set to On.
Pilot Response	<p>Enables selection of the pilot response level when connected to an Evolution autopilot.</p> <div style="border: 1px solid black; padding: 2px;"> <p>Note: Pilot Response is not available on SPX and SeaTalk autopilots.</p> </div>	<ul style="list-style-type: none"> • Leisure • Cruise • Performance
Audio Controls	<p>Displays the audio controls pop-up.</p> <div style="border: 1px solid black; padding: 2px;"> <p>Note: Not available on non-touch displays.</p> </div>	Only available when connected to an audio device via bluetooth.
Ground Trip Resets	Resets the chosen ground trip distance counter to zero.	
System Settings	Enables you to configure the settings for external devices connected to the display.	
Maintenance	Provides diagnostic information. Also enables you to designate the data master and reset the display to factory settings.	

Ground trip resets menu

This menu enables you to reset the chosen ground trip distance counter to zero.

Menu item	Description
Ground Trip 1 Reset	Resets the ground trip 1 distance counter to zero.
Ground Trip 2 Reset	Resets the ground trip 2 distance counter to zero.
Ground Trip 3 Reset	Resets the ground trip 3 distance counter to zero.
Ground Trip 4 Reset	Resets the ground trip 4 distance counter to zero.

System settings menu

Menu item	Description	Options
Autopilot Control	Enables and disables autopilot controls from your multifunction display.	<ul style="list-style-type: none"> On Off
DSC Alerts	Enables and disables DSC radio alerts on your multifunction display.	<ul style="list-style-type: none"> On Off
GPS Set-up	Provides GPS setting options.	<ul style="list-style-type: none"> View Satellite Status Differential GPS COG/SOG Filter Restart GPS
Internal GPS	Switches the multifunction displays internal GPS On or Off. Note: The Internal GPS option is not available on the e165 multifunction display.	<ul style="list-style-type: none"> On Off
Data Sources	Enables selection of preferred sources of data for connected equipment. Note: The Data Sources menu is only available on displays set as Data Master.	<ul style="list-style-type: none"> GPS GPS Datum Time and Date Heading Depth Speed Wind
External Devices	Enables set-up of compatible externally connected devices.	Refer to the <i>External devices menu</i> section of the manual.
Wireless Connections	Provides access to the Wi-Fi and bluetooth connection options.	Refer to the <i>Wireless connections menu</i> section of the manual.

Menu item	Description	Options
NMEA Set-up	Enables you to configure settings for NMEA devices.	Refer to the <i>NMEA set-up menu</i> section of the manual.
System Preferences	Enables you to configure system settings	Refer to the <i>System preferences menu</i> section of the manual.
Simulator	Switches simulator mode On or Off.	<ul style="list-style-type: none"> Off On On (Demo movie)

GPS Status

The GPS status page enables you to view the status of the available satellites that are compatible with your receiver.

The satellite constellations are used to position your vessel in the Chart and Weather applications. You can set up your receiver and check its status from the GPS Set-up menu: **Homescreen > Set-up > System Settings > GPS Set-up**. For each satellite, the screen provides the following information:

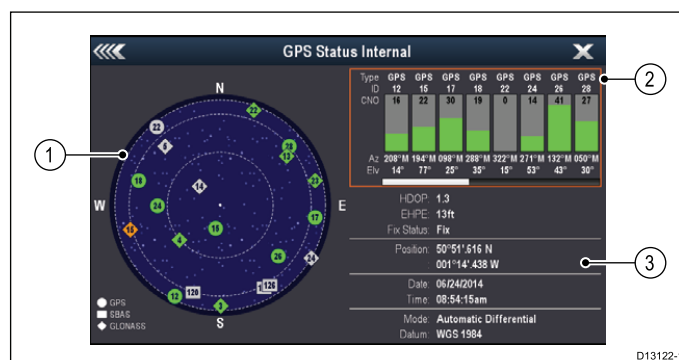

1. Sky view
2. Satellite status
3. Position and fix information

Sky view

Sky view is a visual representation that shows the position of navigation satellites and their type. Satellite types are:

- **Circle** — A circle identifies a satellite from the GPS constellation.
- *** Diamond** — A diamond identifies a satellite from the GLONASS constellation.
- **Square** — A square identifies an (SBAS) differential satellite.

Note: GLONASS satellites are only available when connected to a compatible receiver such as the built-in receiver of an a9x or a12x MFD.

Satellite status area

The Satellite status area displays the following information about each satellite:

- **Type** — Identifies which constellation the satellite belongs to.
- **ID** — Displays the satellites identification number.
- **CNO** (Carrier-to-noise ratio) — Displays the signal strength of each satellite shown in the Sky view:
 - Grey = searching for satellite
 - Green = satellite in use
 - Orange = tracking satellite
- **Azimuth and Elevation** — Provides the angle of elevation and azimuth between the location of the receiver and the satellite.

Position and fix information

The following positional and fix information is provided:

- **Horizontal Dilution of Precision (HDOP)** — HDOP is a measure of satellite navigation accuracy, calculated from a number of factors including satellite geometry, system errors in the data transmission and system errors in the receiver. A higher figure signifies a greater positional error. A typical receiver has an accuracy of between 5 and 15 m. As an example, assuming a receiver error of 5 m, an HDOP of 2 would represent an error of approximately 15 m. Please remember that even a very low HDOP figure is NO guarantee that your receiver is providing an accurate position. If in doubt, check the displayed vessel position in the Chart application against your actual proximity to a known charted object.
- **Estimated Horizontal Position Error (EHPE)** — EHPE is a measure of the estimated error of a position fix in the horizontal plane. The value displayed indicates that your position is within a circle radius of the stated size 50% of the time.
- **Fix status** — indicates the actual mode the receiver is reporting:
 - **Fix** — Satellite fix has been acquired.
 - **No Fix** — No satellite fix can be acquired.
 - **D Fix** — A differential beacon fix has been acquired.
 - **SD Fix** — A differential satellite fix has been acquired.
- **Position** — Displays the latitude and longitude position of your receiver.
- **Date / Time** — Displays the current date and time generated by the position fix in UTC format .
- **Mode** — Identifies whether the receiver is working in differential mode or non-differential mode.
- **Datum** — The receiver's datum setting affects the accuracy of the vessel position information

displayed in the Chart application. In order for your receiver and MFD to correlate accurately with your paper charts, they must be using the same datum.

Multiple data sources (MDS) overview

Installations that include multiple instances of data sources can cause data conflicts. An example is an installation featuring more than one source of GPS data.

MDS enables you to manage conflicts involving the following types of data:

- GPS Position.
- Heading.
- Depth.
- Speed.
- Wind.

Typically this exercise is completed as part of the initial installation, or when new equipment is added.

If this exercise is NOT completed the system will automatically attempt to resolve data conflicts. However, this may result in the system choosing a source of data that you do not want to use.

If MDS is available the system can list the available data sources and allow you to select your preferred data source. For MDS to be available all products in the system that use the data sources listed above must be MDS-compliant. The system can list any products that are NOT compliant. It may be necessary to upgrade the software for these non-compliant products to make them compliant. Visit the Raymarine website (www.raymarine.com) to obtain the latest software for your products. If MDS-compliant software is not available and you do NOT want the system to automatically attempt to resolve data conflicts, any non-compliant product(s) can be removed or replaced to ensure the entire system is MDS-compliant.

Data sources menu

This menu enables you to select the external sensors and devices that will provide data to the display.

Auto / manual selection

Each dialog enables you to view and select your preferred data source. selection of data source can be manual or set to automatic:

- **Auto** — the display will automatically select a device and attempt to resolve any data conflicts that may occur where there is more than one source of data for that particular data source (for example, multiple GPS receivers).
- **Manual** — once the display has performed a search for connected devices you can manually select the preferred device from the list.

Note: Selecting the **Auto** option may result in the system choosing a source of data that you do not want to use.

Device selection

Menu item	Description
GPS	Enables you to search for any externally-connected GPS devices, and select the one you want to use.
GPS Datum	In order for your GPS receiver and multifunction display to correlate accurately with your paper charts, they must be using the same datum. This option enables you to choose the data source for this datum.
Time and Date	Enables you to select the device you want to use for the time and date information used by the display.
Heading	Enables you to select the device you want to use for heading data.
Depth	Enables you to select the device you want to use for depth data.
Speed	Enables you to select the device you want to use for speed data.
Wind	Enables you to select the device you want to use for wind data.

External devices menu

This menu enables you to configure the external devices connected to the display.

Menu item	Description	Notes
Pilot Set-up	When connected to an Evolution autopilot this option allows you to enable and disable pilot control and the pilot bar. You can also access certain pilot settings and modes.	
Fishfinder Set-up	Enables you to select an external transducer and configure the options for the unit, such as depth offset. Also enables you to configure the options for an internal or external sonar module.	For an explanation of these options refer to the <i>Transducer set-up menu options</i> described in the Fishfinder section of this document.
AIS Unit Set-up	Enables you to configure additional functions for AIS units, such as Silent Mode. This menu item is only available when an AIS unit is detected or when Simulator mode is On.	For an explanation of these options refer to the <i>AIS menu options</i> described in the AIS section of this document.
Remote Control	Enables you to customize certain controls for Raymarine Bluetooth remote control units (for example, RCU-3).	For an explanation of these options refer to the <i>Remote Control</i> section of this document.
Transducers Set-up	Displays a list of connected transducers which you can select and calibrate.	
Weather Set-up	Enables you to select the bus your weather receiver is connected to: <ul style="list-style-type: none"> • SeaTalk^{hs} • SeaTalk^{ng} 	
Switch Panel Set-up	Enables you to install and uninstall Switch Panel configuration files.	
External Keypad	Enables you to pair and unpair remote keypads.	
Engines Set-up	Enables you to run the engine identification wizard	For an explanation of these options refer to <i>Engine identification wizard</i> section of this document.

Connections menu

This menu enables you to connect wireless Bluetooth and Wi-Fi devices to the display.

Menu item	Description	Options
Bluetooth	Enable or disable Bluetooth on the display.	<ul style="list-style-type: none"> • On • Off (default)
Wi-Fi	Enable or disable Wi-Fi on the display.	<ul style="list-style-type: none"> • On • Off (default)
Connection Manager	<p>Provides a list of Bluetooth devices in range. When you highlight a connection in the list and press OK, the following options are available:</p> <ul style="list-style-type: none"> • Unpair / Forget this device — Disconnect the device and remove it from the connection list. If you unpair a device in this way you must re-pair the device if you want to connection it again to the multifunction display. • Audio Control — If this option is set to On, you can control the audio for a compatible wireless media player, from the multifunction display. 	<ul style="list-style-type: none"> • Unpair / Forget this device • Audio control On / Off.
New Bluetooth Connection	Selecting this menu item initiates the Bluetooth pairing process. This is necessary for connecting a wireless remote control unit or media player device to the multifunction display.	
Wi-Fi Name	Enables you to specify an SSID (WiFi Name) for connecting WiFi devices using an encrypted connection. If you want to prevent unauthorized devices from connecting to your display you must specify the same SSID for both the multifunction display and the wireless device you want to connect to the display.	
Wi-Fi Security	You can encrypt the WiFi connection on the multifunction display to prevent unauthorized devices from accessing the connection. This menu item enables you to select the type of WPA (WiFi Protected Access) encryption you want to use. WPA2 provides stronger security than WPA.	<ul style="list-style-type: none"> • None • WPA Only • WPA 2 Only. (default) • WPA / WPA2.
Wi-Fi Passphrase	Enables you to specify a password for the WiFi connection. If you want to prevent unauthorized devices from connecting to your display you must specify the same password for both the multifunction display and the wireless device you want to connect to the display.	
Wi-Fi Channel	By default the multifunction display automatically selects an available WiFi channel. If you're experiencing difficulties with wireless video streaming it may be necessary to manually specify a WiFi channel for both the multifunction display and the device you want to stream video to.	<ul style="list-style-type: none"> • 1 (default) • 2 • 3 • 4 • 5 • 6 • 7 • 8 • 9 • 10 • 11
Mobile apps	Enables you to select the type of mobile app in use:	<ul style="list-style-type: none"> • Off (default) • Viewing only

Menu item	Description	Options
	<ul style="list-style-type: none">• Viewing only — RayView• Remote Control — RayRemote or RayControl	<ul style="list-style-type: none">• Remote Control

NMEA Set-up menu

This menu enables you to configure settings for NMEA devices.

Menu item	Description	Options
Bridge NMEA Heading	If set to ON, NMEA heading data will be bridged onto the SeaTalk data bus, and will be sent to all NMEA-connected devices. If set to OFF, NMEA heading data will NOT be bridged onto the SeaTalk bus. An example of a use for this setting is when using MARPA with an external fast heading sensor, in which case you should set this option to OFF to ensure that all NMEA-connected units receive heading data from the external heading sensor.	<ul style="list-style-type: none"> • On • Off (default)
NMEA Output Settings	Allows you to enable or disable the individual NMEA "sentences" that are sent by the multifunction display to any devices connected the NMEA output port.	<ul style="list-style-type: none"> • APB • BWC • BWR • DBT • DPT • GGA • GLL • GSA • GSV • MTW • MWV • RMA • RMB • RMC • RSD • RTE • TTM • VHW • VLW • VTG • WPL • ZDA
NMEA Input Port 1	Enables you to specify the appropriate port speed for the equipment connected to NMEA Input port 1. Use the AIS 38400 option for AIS receivers.	<ul style="list-style-type: none"> • NMEA 4800 • AIS 38400
NMEA Input Port 2	Enables you to specify the appropriate port speed for the equipment connected to NMEA Input port 2. Use the AIS 38400 option for AIS receivers.	<ul style="list-style-type: none"> • NMEA 4800 • AIS 38400

System preferences menu

Menu item	Description	Options
Bearing mode	Determines how all bearing and heading data is displayed in. This does not affect how the chart or radar displays are drawn.	<ul style="list-style-type: none"> • True (default) • Magnetic
Variation Source	This setting compensates for the naturally occurring offset of the earth's magnetic field. When set to Auto, the system automatically compensates, and displays the compensation value in brackets. To enter your own compensation value, use the Manual option, then specify the value using the Manual Variation setting (see below). This value is also transmitted to any other connected Raymarine instruments.	<ul style="list-style-type: none"> • Auto (compensation value displayed) (default) • Manual
Manual Variation	When the Variation Source menu item is set to Manual (see above), you use the Manual Variation setting to specify the compensation value that you want to use.	<ul style="list-style-type: none"> • Range: 0 to 30 degrees, East or West •
System Datum	<p>In order for your GPS receiver and multifunction display to correlate accurately with your paper charts, they must be using the same datum. The default datum for your multifunction display is WGS1984. If this is not the datum used by your paper charts, you can change the datum used by your multifunction display.</p> <p>When you change the datum for your multifunction display, the chart grid will subsequently move according to the new datum, and the latitude / longitude of the cartographic features will also change accordingly. Your multifunction display will attempt to set up any GPS receiver to the new datum, as follows:</p> <ul style="list-style-type: none"> • The internal GPS receiver will automatically correlate each time you change the datum. • If you have a Raymarine GPS receiver using SeaTalk or SeaTalk^{ng}, it will automatically correlate each time you change the datum on the multifunction display. • If you have a Raymarine GPS receiver using NMEA 0183, or a third-party GPS receiver, you must correlate it separately. <p>It may be possible to use your multifunction display to correlate an NMEA 0183 GPS receiver. From the homescreen go to Set-up > System settings > GPS Set-up > View Satellite Status. If the datum version is displayed, it may be possible to change it. From the homescreen go to Set-up > System settings > Data Sources > GPS Datum.</p> <div style="border: 1px solid black; padding: 5px; margin-top: 10px;"> <p>Note: Raymarine recommends that you check the displayed vessel position in the chart application against your actual proximity to a known charted object. A typical GPS has an accuracy of between 5 and 15 m.</p> </div>	

Maintenance menu

This menu provides access to systems settings reset and diagnostics.

Menu item	Description	Options
Touchscreen Alignment	<p>If the touchscreen is misaligned to your touch, you can realign it to improve the accuracy. Realignment involves a simple exercise to align an on-screen object with your touch. For best results, perform this exercise when your vessel is anchored or moored.</p> <div style="border: 1px solid black; padding: 5px; margin-top: 10px;"> <p>Note: The Touchscreen alignment option is not required on New c Series displays.</p> </div>	
Data Master	Any system containing more than one networked multifunction display must have a designated data master. The data master is the display which serves as a primary source of data for all displays, it also handles all external sources of information.	
System Settings Reset	This option resets your menu options, datapages, and databar settings to factory default. It will NOT affect your waypoints, routes, or tracks data.	<ul style="list-style-type: none"> • Yes • No
System Settings and Data Reset	In addition to the settings reset detailed above, performing a settings and data reset will also remove ALL waypoints, routes, and tracks data.	<ul style="list-style-type: none"> • Yes • No
Diagnostics	<p>Diagnostics provides detailed information on the multifunction display and connected devices. The range of information available includes product serial number, software version, and network status. When you select the Diagnostics menu item the multifunction display scans for any connected equipment and enables you to select the product you want to view. You can also save the diagnostics information to a memory card. This is particularly useful for sending detailed information to Raymarine Customer Support in the event of a technical issue.</p> <p>The Interfaces option allows you to view statistics and buffer information for NMEA 0183 ports 1 and 2 and SeaTalk[®].</p> <p>The Sirius options allows you to view received messages, memory and errors.</p>	<ul style="list-style-type: none"> • Select Device • Sirius • Save Logs • Erase Logs • Interfaces

Diagnostics menu

If you encounter problems with your multifunction display or peripheral devices you can use the Diagnostics menu to view information about your device and connected equipment.

Select Device	Enables you to view a list of all devices connected to the SeaTalk ^{hs} network. You can also select an item in the list to view further details for that device.	<ul style="list-style-type: none"> • Device • Serial No. • Network • Software
Sirius	If connected to a Sirius weather receiver this option enables you to view Sirius weather statistics.	
Save Logs	Allows you to save error logs to a MicroSD card for troubleshooting purposes.	
Erase Logs	Selecting this option will erase any crash logs on the device.	
Interfaces	Enables viewing of statistics and viewing and recording of buffers on NMEA inputs and the SeaTalk ^{ng} bus. On multifunction displays with multiple MicroSD card slots you can also choose which MicroSD card slot the buffer will be recorded to.	<ul style="list-style-type: none"> • NMEA 1 • NMEA 2 • SeaTalk^{ng} • Record File

Chapter 10: Document viewer application

Chapter contents

- [10.1 Document viewer overview on page 148](#)

10.1 Document viewer overview

You can view PDF documents on your multifunction display.

The document viewer is available from the homescreen and is used to view and search PDF documents (such as product handbooks).

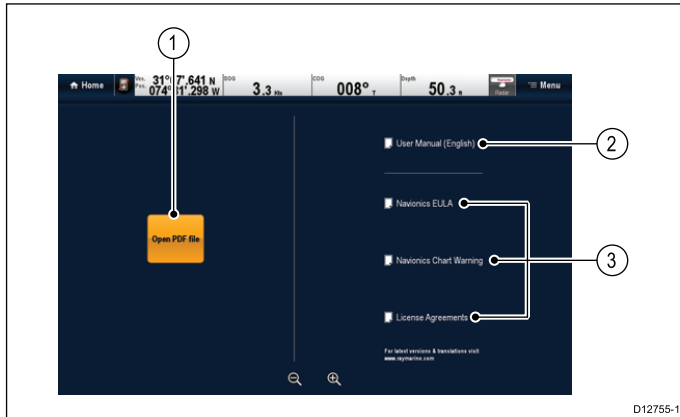

D12755-1

1	Opens the MicroSD card file browser.
2	Opens the user manual stored on the multifunction display.
3	Opens the relevant license agreement information.

Note: The document viewer does not support password protected documents or documents containing security certificates. An error message will be displayed if you try to open such documents.

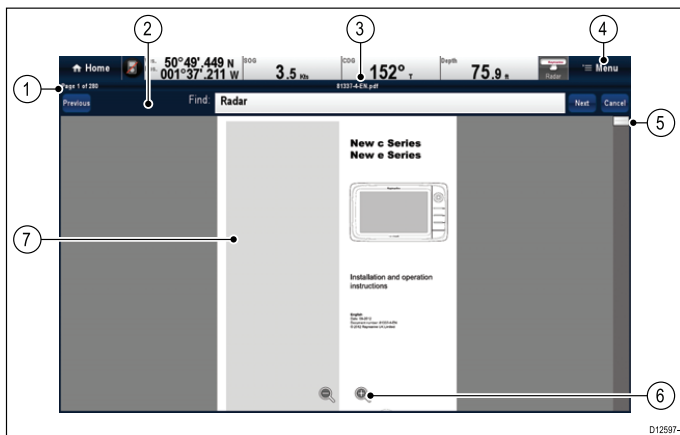

D12597-1

1	Current page number (page x of y).
2	Find (search) tool bar (only displayed when searching a document). Note: The Previous, Next and Cancel buttons are only shown on touch-only products. For non-touch and Hybridtouch products the physical buttons are used.
3	Filename of the current PDF.
4	Document viewer menu.
5	Scroll bar.
6	On-screen zoom controls (Touchscreen displays only).
7	PDF document content.

The following options are available from the document viewer menu:

- **Open File** — Allows you to browse a MicroSD card or the MFD's internal storage for a PDF document to open.
- **Go to page:** — Allows you to jump to a specific page number.
- **Find** — Allows you to search the document for specific words.
- **Fit to Height** — Scales the open document to fit the height of the application window.
- **Fit to Width** — Scales the open document to fit the width of the application window.
- **Close File** — Closes the open document.

Opening the user manual

The product user manual is stored on the internal memory.

From the homescreen:

1. Select **Doc Viewer**.
2. Select **User Manual**.

The product user manual is opened.

Note: The User manual can also be opened by selecting the **User Manual** icon from the Homescreen.

Opening a PDF document

You can open PDF documents stored on a MicroSD card by following the steps below.

Note: When saving PDF documents to MicroSD cards, ensure you do not overwrite important data.

1. Save the required PDF document to a MicroSD card.
2. Insert the MicroSD card into the multifunction display's MicroSD card slot.
3. Select **Menu**.
4. Select **Open File**.
The file browser dialog is displayed.
5. Browse the MicroSD card containing the document you want to view.
6. Select the document you want to view.
The document will now open.
7. If the 'Cannot Open File' error message is displayed, select **Ok** to confirm and then try opening the document again. Check that the PDF is not corrupted. Also ensure that the PDF does not include password protection or a security certificate. These PDF file security features are not supported by the document viewer application.

Note: Large filesize PDF documents may take a while to open.

Closing an open document

Each Doc viewer instance is separate, the last document opened will automatically open next time you select that instance of the Doc viewer unless it is closed using the Close File menu option.

With a document open

1. Select **Menu**.
2. Select **Close file**.
The document is close and the main Doc viewer page is displayed.



Browsing an open document

On touchscreen displays you can browse pdf documents as detailed below.

With a pdf document open:

	<ul style="list-style-type: none"> • Move your finger up to scroll down the document. • Move your finger down to scroll up the document.
	<p>When the document width is greater than the width of the application window, move your finger left or right to pan the width of the document.</p>

Note: You can also use the scroll bars to navigate through the document.



Browsing an open document

On HybridTouch and non-touch displays you can browse pdf documents by following the steps below.

With a pdf document open:

1. Move the Joystick **Up** or **Down** to move up and down through the document.
2. Move the Joystick **Left** or **Right** to pan left and right.



Changing the zoom factor

On touchscreen displays you can change the zoom factor of the open document by following the steps below.

With a pdf document open:

1. Select the on-screen **Zoom in** icon to zoom in, or
2. Select the on-screen **Zoom out** icon to zoom out.



Changing the zoom factor

On HybridTouch and non-touch displays (excluding the e7 and e7D) you can change the zoom factor of the open document by following the steps below.

With a pdf document open:

1. Use the **Range out** button to zoom out, or
2. Use the **Range in** button to zoom in.

Note: New a Series and e7 / e7D multifunction displays do not have Range in and Range out button.

Note: On a New c Series display only the **Rotary control** can be used to change the zoom factor.

Selecting a page

You can skip to the page you want to view by entering the page number.

With a pdf document open:

1. Select **Menu**.
2. Select **Go to page:**.
The numeric keypad is displayed.
3. Enter the page number of the page you want to view.
4. Select **Ok** to view the page.



Using document hyperlinks

On touchscreen displays you can use internal document hyperlinks.

With a pdf document opened on a page containing a hyperlink:

1. Momentarily touch your finger on the hyperlink.
You will be taken to the hyperlinked page.

Note: Document hyperlinks cannot be activated on a New c Series display.



Searching for text

To use the find function to search for text on touch only display follow the steps below.

With a pdf document open:

1. Select **Menu**.
2. Select **Find**.
The on-screen keyboard is displayed.
3. Enter the keyword you want to find.
4. Select **SAVE**.
The document viewer will enter find mode and:
 - You may see a 'Searching' icon while all occurrences are found.
 - The find tool bar is displayed.
 - The first occurrence of the keyword is highlighted.
5. Select **Next** to find the next occurrence of the keyword, or
6. Select **Previous** to go back to the last occurrence of the keyword.
7. You can select **Cancel** at any time to close the find tool bar and return to the normal viewing.



Searching for text

On HybridTouch and non-touch displays you can use the find function to search for text in an open pdf document by following the steps below.

With a pdf document open:

1. Press the **Menu** button.
2. Select **Find**.
The on-screen keyboard is displayed.
3. Enter the keyword you want to find.
4. Select **SAVE**.
The document viewer will enter find mode and:
 - You may see a 'Searching' icon while all occurrences are found.

- The find tool bar is displayed.
 - The first occurrence of the keyword is highlighted.
5. Move the **Joystick Down** to go to the next occurrence of the keyword, or
 6. Move the **Joystick Up** to go to the previous occurrence of the keyword.
 7. You can press the **Back** button at any time to close the find tool bar and return to the normal viewing.

Keyword not found

The document viewer will let you know if the keyword you have searched for does not appear in the document.

If the keyword is not found then the find tool bar will display an exclamation mark and a pop-up message is displayed on-screen.

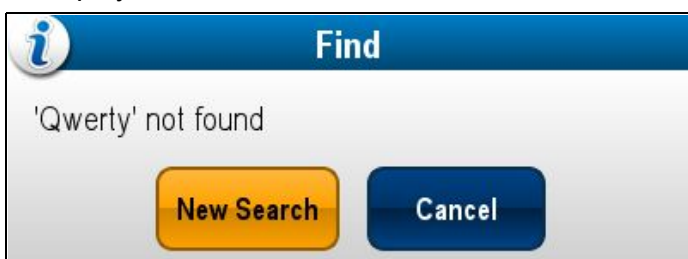

Selecting **New Search** will take you back to the on-screen keyboard so that you can try a different keyword. Selecting **Cancel** will close the find tool bar and resume normal operation.

Chapter 11: Autopilot control

Chapter contents

- [11.1 Autopilot Control overview and features on page 152](#)
- [11.2 Enabling autopilot control on page 152](#)
- [11.3 Engaging the autopilot on page 153](#)
- [11.4 Adjusting the current locked heading on page 153](#)
- [11.5 Disengaging the autopilot on page 154](#)
- [11.6 Manually displaying the pilot control dialog box on page 155](#)
- [11.7 Pilot Control dialog on page 155](#)
- [11.8 Pilot Bar on page 156](#)
- [11.9 Pilot Set-up on page 157](#)
- [11.10 Pilot settings on page 157](#)
- [11.11 Commissioning on page 160](#)
- [11.12 Autopilot status symbols on page 164](#)
- [11.13 Autopilot alarms on page 164](#)

11.1 Autopilot Control overview and features

Raymarine® autopilots can be controlled directly from a compatible LightHouse powered **MFD**, with or without a dedicated Pilot control head.

Note: For information on connecting a **Raymarine**® autopilot to a compatible **MFD**, refer to the documentation that accompanied your autopilot.

The **MFD** can be used to:

Control a connected Autopilot.	• 6.11 Enabling autopilot control
Engage the autopilot in Track mode (Goto a specified position or follow a route) or Auto mode (Remain on the current heading).	• 11.3 Engaging the autopilot
Adjust the current locked heading when in Auto mode.	• 11.4 Adjusting the current locked heading
Disengage the autopilot.	• 11.5 Disengaging the autopilot
Provide close integration with the Chart application for seamless navigation.	• 18.3 Navigation options
Select different performance modes, when connected to an Evolution autopilot.	• 11.9 Pilot Set-up
Adjust the Pilot Settings , when connected to an Evolution autopilot.	• 11.10 Pilot settings
Manage autopilot alarms.	• 11.13 Autopilot alarms

Note: In a system that does not include a dedicated Pilot control head the Data Master **MFD** cannot be switched Off or put into **PowerSave** mode whilst the autopilot is engaged.

11.2 Enabling autopilot control

Enabling the autopilot control function — SeaTalk and SPX SeaTalk^{ng} autopilots

To enable control of your SeaTalk or SPX SeaTalk^{ng} autopilot using your multifunction display follow the steps below.

From the Homescreen:

1. Select **Set-up**.
2. Select **System Settings**.
3. Select **Autopilot Control** so that On is highlighted.
Selecting Autopilot Control will switch the control between On and Off.

On a system containing multiple displays the pilot control is enabled on all displays at the same time.

Enabling the autopilot control function — Evolution autopilots

To enable control of your Evolution autopilot using your multifunction display follow the steps below.

From the Homescreen.

1. Select **Set-up**.
2. Select **System Settings**.
3. Select **External Devices**.
4. Select **Pilot Set-up**.
5. Select **Pilot control** so that On is highlighted.
Selecting Pilot control will switch the Autopilot control function on and off.

11.3 Engaging the autopilot

Engaging the autopilot using the pilot button

On multifunction displays which have a dedicated pilot button or when using a remote keypad you can engage the autopilot using the Pilot button.

With the autopilot disengaged:

1. Press the **Pilot** button.
The pilot control dialog is displayed.
2. Select **Auto**.
The autopilot is engaged and will maintain the current heading.

Note: You can also automatically engage the autopilot by pressing and holding the **Pilot** button.

Engaging the autopilot from the chart application menu

You can engage the autopilot in track mode using the application menu.

In the chart application:

1. Select **Menu > Navigate > Goto Cursor, Goto Waypoint, or Follow Route** as appropriate.
The Pilot Control dialog is displayed.
2. Select **Yes (Track)**.

Engaging the autopilot using the context menu

You can engage the autopilot in track mode using the context menu.

From the chart application context menu.

1. Select any of the following options from the Chart context menu:
 - **Goto Waypoint**
 - **Goto Cursor**
 - **Follow Route**
 - **Follow from Here**
 - **Follow Route in Reverse**The pilot control dialog is displayed.
2. Select **Yes (Track)**.

11.4 Adjusting the current locked heading

When the autopilot is in **Auto** mode the current locked heading can be adjusted from the **Pilot Control** dialog and from the **Pilot Bar**.

With the **Pilot Bar** or **Pilot Control** dialog displayed:

1. Use the **Left Arrow** icon to decrease the current locked heading, or
2. Use the **Right Arrow** icon to increase the current locked heading.

11.5 Disengaging the autopilot

Caution: Disengaging the autopilot

On integrated multifunction displays that do not have a dedicated pilot button, in an emergency the autopilot can be disengaged by pressing and holding the Power button.

Disengaging the autopilot using the Power button

On integrated multifunction displays that do not have a dedicated pilot button, when the autopilot is engaged it can be disengaged using the power button. This is useful in emergency situations, especially on touch only displays in the event the touchscreen becomes unresponsive due to adverse weather conditions e.g. rain.

With the autopilot engaged:

1. Press and hold the **Power** button.
A 'Setting pilot to STANDBY' warning is displayed and an audible alarm is sounded.
2. Continue to hold the **Power** button and the pilot will be placed into standby mode then the Pilot control dialog is displayed.

Disengaging the autopilot using the shortcuts page

You can disengage the autopilot from the Shortcuts page.

With the autopilot engaged:

1. Press and release the **POWER** button.
2. Select **Standby**.
The Pilot Status change confirmation pop-up is displayed.
3. Select **Yes** to disengage the autopilot.

The autopilot is disengaged (put into standby) and the Pilot Control dialog is displayed.

Disengaging the autopilot using the pilot button

On multifunction displays which have a dedicated pilot button or when using a remote keypad you can disengage the autopilot using the Pilot button.

With the autopilot engaged:

1. Press the **Pilot** button.

The autopilot is disengaged (put into standby) and the Pilot Control dialog is displayed.

Disengaging the autopilot from the chart application

On all multifunction display variants the autopilot can be disengaged from the chart application's menu.

In the chart application with the autopilot engaged:

1. Select **Menu > Navigate > Stop Goto** or **Stop Follow**.

The Pilot Control dialog is displayed.

2. Select **STANDBY**.

The Pilot Status change confirmation pop-up is displayed.

3. Select **Yes** to disengage the autopilot.

The autopilot is disengaged (put into standby).

Disengaging the autopilot from the homescreen

On Touchscreen displays the autopilot can be disengaged from the Homescreen.



From the Homescreen:

1. Select **Standby**.
The Pilot Status change confirmation pop-up is displayed.
2. Select **Yes** to disengage the autopilot.
The autopilot is disengaged (put into standby).

Disengage the autopilot from the pilot bar

The autopilot can be disengaged from the Pilot bar.



With the Pilot Bar displayed:

1. Select **Standby**.

Refer to [11.8 Pilot Bar](#) for further information on the Pilot Bar.

11.6 Manually displaying the pilot control dialog box

You can also open the Pilot Control dialog at any time from the homescreen or chart application.

1. From the homescreen:
 - i. Select **Set-up**.
 - ii. Select **Pilot Controls**.
2. From the chart application:
 - i. Select **Menu**.
 - ii. Select **Navigate**.
 - iii. Select **Pilots Controls**.

11.7 Pilot Control dialog

The **Pilot Control** dialog can be used to control autopilot functions.

Pilot Control dialog (standby)

The example below shows the **Pilot Control** dialog options when the dialog is opened from a menu or using a dedicated **Pilot** button.



Selecting **Auto** will engage the autopilot and maintain the current heading.

Pilot Control dialog (Auto)

The example below shows the **Pilot Control** dialog options when **Auto** (locked heading) has been engaged.

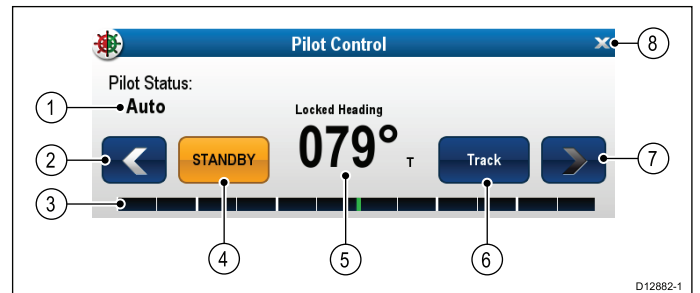

	Description
1	Pilot Status — Current pilot mode.
2	Left Arrow — Decrease locked heading angle.
3	Rudder bar — Indicates the position of the rudder.
4	STANDBY — Disengages the autopilot and returns to manual vessel control.
5	Current locked heading.
6	Track — Engages the autopilot in Track mode and automatically steers your vessel to a target waypoint or along a route plotted on your chartplotter.
7	Right Arrow — Increase locked heading angle.
8	Close — Closes the Pilot Control dialog.

Pilot Control dialog (Starting navigation)

The example below shows the **Pilot Control** dialog options when **Goto Cursor**, **Goto Waypoint** or **Follow Route** has been selected.

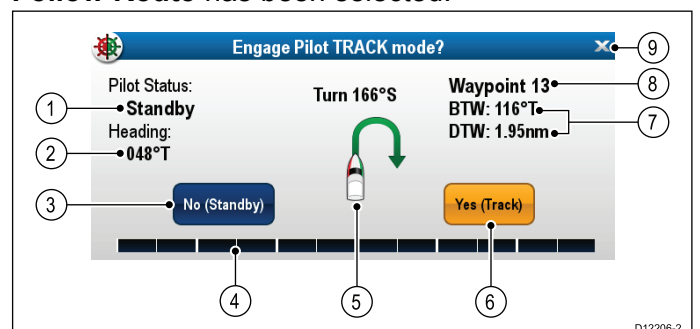

	Description
1	Pilot Status — Current pilot mode.
2	Current Heading.
3	No (Standby) — Disengages the autopilot and returns to manual vessel control.
4	Rudder bar — Indicates the position of the rudder.
5	Turn angle — The turn angle is only available for SeaTalk^{ng} autopilots. This indicates the direction and severity of turn.
6	Yes (Track) — Engages the autopilot in Track mode and automatically steers your vessel to a target waypoint or along a route plotted on your MFD .
7	Distance to next waypoint (DTW) and Bearing to next waypoint (BTW).
8	Next Waypoint name.
9	Close — Closes the Pilot Control dialog.

Pilot Control dialog (Track)

The example below shows the **Pilot Control** dialog options when in track mode.

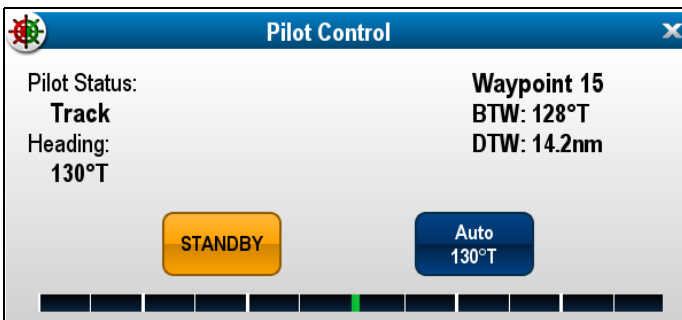

Displaying the Pilot Control dialog

The Pilot Control dialog is displayed under the following conditions:

1. When the physical **Pilot** button is pressed.
2. When **Pilot Controls** selected from the shortcuts page.
3. When you select **Menu > Navigate > Goto Waypoint**, **Goto Cursor** or **Follow Route** option in the Chart application.
4. When you select **Goto Waypoint** or **Goto Cursor** using the Chart context menu.
5. When you place the cursor over an active route or waypoint in the Chart application and select **Stop Goto**, **Stop Follow** or **Advance Waypoint** from the context menu.
6. When you are following a route or going to a waypoint or cursor position, and select **Menu > Navigate > Stop Goto**, **Stop Follow**, or **Advance Waypoint**.
7. When you arrive at a target waypoint.

Note: When arriving at a waypoint, the dialog title bar turns red to indicate waypoint arrival.

11.8 Pilot Bar

The Pilot Bar provides autopilot status information. For touchscreen displays you can disengage the autopilot using the Pilot Bar.

Pilot Bar — Track mode



Pilot Bar — Auto mode

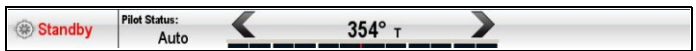

The Pilot Bar is displayed when autopilot control is enabled, the Pilot Bar is switched on and the autopilot is engaged.

When the autopilot is disengaged the Pilot Bar is hidden.

On a system containing multiple displays the Pilot Bar can be disabled or enabled on each display.

Enabling the Pilot Bar

When connected to a SeaTalk or SeaTalk^{ng} SPX autopilot the Pilot Bar can be enabled by following the steps below.

From the Homescreen, with autopilots controls enabled:

1. Select **Customize**.
2. Select **Display Preferences**.
3. Select **Pilot Control Bar** so that Shown is highlighted.

Selecting Pilot Control Bar will switch the Pilot Bar between Shown and Hidden.

4. Engage the autopilot.

The Pilot Bar is now displayed at the bottom of the screen in all applications whilst the autopilot is engaged.

Note: When connected to an Evolution autopilot the Pilot Bar is enabled from the Pilot Set-up page.

11.9 Pilot Set-up

When connected to an Evolution autopilot the Pilot Set-up page is available.

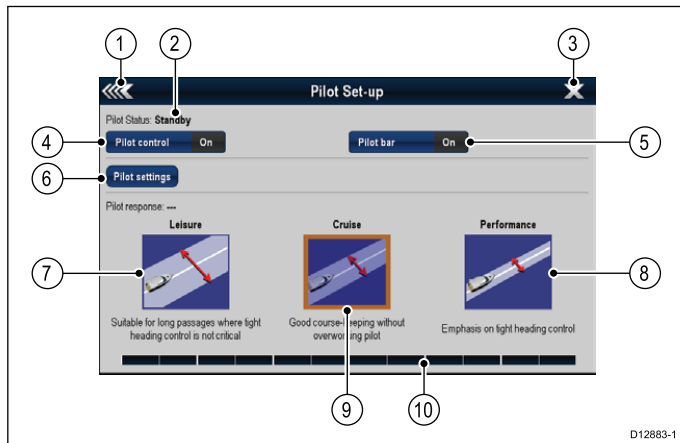

1	Back — Go back to the previous menu.
2	Pilot Status — Current pilot mode.
3	Close — Closes the pilot set-up page and displays the homescreen.
4	Pilot control — Switches autopilot control via the multifunction display on and off.
5	Pilot bar — Switches the Pilot bar on and off.
6	Pilot settings — Displays available pilot settings that can be configured from the multifunction display. Note: The Pilot settings menu is only available on the data master multifunction display.
7	Leisure — Places the autopilot in Leisure mode. Leisure mode is suitable for long passages where tight heading control is not critical.
8	Performance — Places the autopilot in Performance mode. Performance mode provides good course keeping without overworking the autopilot.
9	Cruise — Places the autopilot in Cruise mode. Cruise mode provides tight heading control.
10	Rudder bar — Indicates the position of the rudder.

Accessing the Pilot Set-up page.

When connected to an Evolution autopilot you can access the Pilot Set-up page by following the steps below.

From the Homescreen:

1. Select **Set-up**.
2. Select **System Settings**.
3. Select **External Devices**.
4. Select **Pilot Set-up**.

11.10 Pilot settings

The Pilot settings option is available on a data master multifunction display when it is integrated with an Evolution autopilot.

The Pilot settings enable the setup and commissioning of an Evolution autopilot using a multifunction display.

The Pilot settings include the following options:

- Vessel Settings
- Drive Settings
- Sail Boat Settings
- Commissioning

Initial setup and commissioning

Vessel settings

The vessel settings are designed to provide optimum steering performance for typical vessels.

It is important to complete the vessel hull type selection as part of the initial set-up, as it forms a key part of the autopilot calibration process. You can also access the options at any time by selecting **Pilot Settings > Vessel settings** from the Pilot Set-up page.

Vessel setting include the following options:

- Vessel Hull Type
- Drive Type
- Compass Offset
- Calibration Lock

Vessel hull type selection

The vessel hull type options are designed to provide optimum steering performance for typical vessels.

It is important to complete the vessel hull type selection as part of the commissioning process. You can also access the options at any time with the pilot in Standby from the Pilot Set-up page by selecting: **Pilot Settings > Vessel Settings > Vessel Hull Type**.

As a general guide, select the option that most closely matches your vessel type and steering characteristics. The options are:

- **Sail**.
- **Sail (slow turn)**.
- **Sail Catamaran**.
- **Power**
- **Power (slow turn)**.
- **Power (fast turn)**.

It is important to be aware that steering forces (and therefore rate-of-turn) vary significantly depending on the combination of vessel type, steering system, and drive type. Therefore, the available vessel hull type options are provided for guidance only. You may wish to experiment with the different vessel hull type options, as it might be possible to improve the steering performance of your vessel by selecting a different vessel type.

When choosing a suitable vessel type, the emphasis should be on safe and dependable steering response.

Important: If you change the vessel type **after** completing the Dockside wizard, all commissioning settings will be reset to default settings, and you will need to complete the Dockside wizard again.

Selecting a vessel hull type

The Vessel hull type can be accessed from the Pilot Set-up page.

1. Select **Pilot Settings**.
2. Select **Vessel Settings**.
3. Select **Vessel Hull Type**.
4. Select the option that most closely matches your vessel type.

The new selection is applied.

Selecting a drive type

Drive type selection is available from the dockside wizard, and also from the Vessel settings menu:

Pilot Set-up > Pilot Settings > Vessel Type > Drive type.

With the **Drive Type** menu displayed:

1. Select your drive type from the list.

Note: The drive types available are dependant on the ACU type. If your drive type is not listed contact your Raymarine dealer for advice.

2. Select **OK** to save your setting and display the next set-up page.

Note: You can cancel the Dockside wizard at any time by selecting **STANDBY**.

Aligning heading

The autopilot heading can be aligned to the ship's compass using the Compass offset setting.

Note: To perform this procedure you will need a networked device such as an instrument, pilot control head or multifunction display to have the current autopilot heading shown onscreen.

Many factors can cause a difference between heading and course over ground (COG), you must align the heading so it matches the vessel's steering compass (or a known transit bearing).

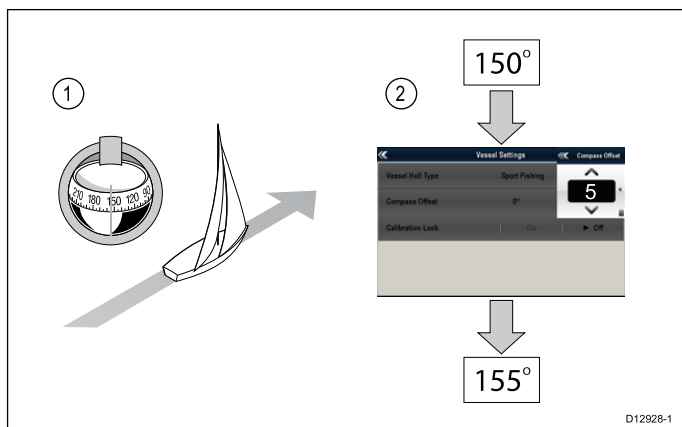

1. Set your vessel on a known heading and check the steering compass.

2. Check the autopilot heading on your multifunction display.
3. From the Pilot Set-up page select **Pilot Settings**.
4. Select **Vessel Settings**.
5. Select **Compass Offset**.
6. Adjust the Compass Offset so that the autopilot heading will match the steering compass heading.

e.g. If the steering compass heading was 155° and autopilot heading was 150° applying a compass offset of 5° would mean that the steering compass and autopilot heading are aligned.

The compass offset will be changed automatically if required when the align compass to GPS procedure is carried out.

Drive settings

The drive settings are designed to provide optimum drive performance.

It is important to check and where necessary adjust the drive settings to suit your drive setup.

Drive settings include the following settings:

- *Rudder Damping.
- Auto Turn.
- Power Steer.
- Reverse rudder ref.
- Rudder Offset.
- Rudder Limit.
- Hard Over Time.

Note: *The rudder damping setting should not be adjusted without first seeking advice from Raymarine technical support.

Setting the auto turn angle

You can specify the angle at which the vessel will turn when performing an Auto Turn using a connected Pilot control Head.

From the Pilot Set-up page:

1. Select **Pilot Settings**.
2. Select **Drive Settings**.
3. Select **Auto Turn**.
4. Adjust the auto turn setting to the required value.
5. Select **Back** or **Ok** to confirm the setting.

Power Steer

If you have a joystick or a p70R pilot control head connected to your autopilot you can select its mode of operation. For detailed information refer to the documentation that accompanied your joystick or your p70R.

The modes of operation are as follows:

- **Off** — Joystick control is turned off.
- **Proportional** — Proportional mode applies rudder in proportion to joystick movement — the further the joystick is held over, the greater the applied rudder.

- **Bang-Bang** — Bang-bang modes applies continuous rudder in the direction of the joystick movement, to improve control, the speed of rudder movement changes with the angle of the joystick. For maximum speed, push the joystick hard over. If you return the joystick to the center position, the rudder will remain in its current position.

Reversing the rudder reference phase

On vessels fitted with a rudder reference transducer, if the rudder bar moves in the wrong direction you can correct this by reversing the phase of the rudder reference.

Note: This procedure is not required on vessels without a rudder reference transducer.

From the Pilot Set-up page:

1. Select **Pilot Settings**.
2. Select **Drive Settings**.
3. Select **Reverse Rudder Ref**.
Selecting Reverse Rudder ref will switch between On and Off.

Setting the rudder offset

On vessels fitted with a rudder reference transducer, you can set an offset to the rudder's center position if required.

Note: This procedure is not required on vessels without a rudder reference transducer.

Note: To perform this procedure it is desirable to have a networked device such as an instrument, pilot control head or multifunction display that can display the current rudder position onscreen whilst making this adjustment.

1. Use the steering wheel to center the rudder.
2. From the Pilot Set-up page select **Pilot Settings**.
3. Select **Drive Settings**.
4. Select **Rudder Offset**.
5. Adjust the Rudder Offset value until the rudder bar shows the rudder in the central position.

The rudder adjustment is limited to $\pm 9^\circ$ if the adjustment required to center the rudder bar position is beyond these limits then the alignment of the rudder reference sensor will need to be physically adjusted.

Setting the rudder limits

On vessels fitted with a rudder reference transducer the rudder limits must be set. The rudder limit is used to set the rudder control. The rudder limits should be set to just inside the mechanical end stops to prevent unnecessary load on the steering system.

Note: This procedure is not required on vessels without a rudder reference transducer.

Note: To perform this procedure it is desirable to have a networked device such as an instrument, pilot control head or multifunction display that can display the current rudder position onscreen whilst making this adjustment.

The limits should be set to approximately 5° less than the maximum rudder angle.

1. Turn the steering wheel all the way to port and note the angle on the rudder bar.
2. Turn the steering wheel all the way to starboard and note the angle on the rudder bar.
3. From the Pilot Set-up page select **Pilot Settings**.
4. Select **Drive Settings**.
5. Select **Rudder Limit**.
6. Adjust the rudder limit to be 5° less than the lowest angle noted in steps 1 and 2 above.
7. Select **Back** or **OK** to confirm the settings.

Setting the hard over time

Once the hard over time has been established it can be set following the steps below.

From the Pilot Set-up page:

1. Select **Pilot Settings**.
2. Select **Drive Settings**.
3. Select **Hard Over Time**.
4. Enter your hard over time in seconds.

Sail boat Settings

When the vessel type has been set to a sail boat the Sail Boat settings menu will be available.

Sail boat settings consist of the following options:

- **Wind Trim Response** — Wind trim response controls how quickly the autopilot system responds to changes in the wind direction. A higher wind trim setting will result in a system that is more responsive to wind changes.
- **Gybe Inhibit** — With gybe inhibit turned on, to prevent accidental gybes, the autopilot will prevent the vessel from performing a turn away from the wind. With gybe inhibit turned off, you can perform an AutoTack into or away from the wind. Gybe inhibit does not effect Auto Turn.
- **Wind Trim** — This option determines whether the vessel steers to Apparent or True wind in when in Wind Vane mode.

Aligning compass to GPS

You can align the autopilot compass to your COG heading.

Aligning the compass must be performed whilst heading into the tide or in slack water.

From the Pilot Set-up page:

1. Select **Pilot Settings**.
2. Select **Commissioning**.
3. Select **Align Compass to GPS**.
4. Steer your vessel on a steady course and then select **Start**.
5. Ensure sufficient vessel speed, if you are going too slow a 'Go Faster' message is displayed.
6. If the alignment is successful select **OK** to complete the procedure.

If required this procedure will automatically correct the compass offset value accessible from the Vessel Settings menu.

Note: If the alignment fails it means that the pilot sensor is more than a 10° deviation between your COG heading and the pilot sensor, in this situation the pilot sensor position must be checked.

11.11 Commissioning

You can commission an Evolution autopilot using the Pilot settings menu on your multifunction display. All set-up and commissioning procedures must be carried out before using the autopilot.

Commissioning the autopilot system consists of the following procedures:

- Vessel Hull Type selection.
- Drive Type selection.
- Rudder check
- Motor check

Commissioning pre-requisites

Before commissioning your system for the first time, check that the following processes have been carried out correctly:

- Autopilot system installation completed in accordance with the Installation instructions.
- SeaTalk^{ng} network installed in accordance with the SeaTalk^{ng} Reference Manual.
- Where fitted, the GPS receiver has been installed and connected in accordance with the associated Installation instructions.

Check also that the commissioning engineer is familiar with the installation and components of the autopilot system including:

- Vessel type.
- Vessel steering system information.
- What the autopilot will be used for.
- System layout: components and connections (you should have a schematic of the vessel's autopilot system).

Vessel hull type selection

The vessel hull type options are designed to provide optimum steering performance for typical vessels.

It is important to complete the vessel hull type selection as part of the initial set-up, as it forms a key part of the commissioning process. You can also access the options at any time with the pilot in Standby from the Pilot Set-up page by selecting: **Pilot Settings > Vessel Settings > Vessel Hull Type**.

As a general guide, select the option that most closely matches your vessel type and steering characteristics. The options are:

- **Sail**.
- **Sail (slow turn)**.
- **Sail Catamaran**.
- **Power**
- **Power (slow turn)**.
- **Power (fast turn)**.

It is important to be aware that steering forces (and therefore rate-of-turn) vary significantly depending on the combination of vessel type, steering system, and drive type. Therefore, the available vessel hull

type options are provided for guidance only. You may wish to experiment with the different vessel hull type options, as it might be possible to improve the steering performance of your vessel by selecting a different vessel type.

When choosing a suitable vessel type, the emphasis should be on safe and dependable steering response.

Important: If you change the vessel type **after** completing the Dockside wizard, all commissioning settings will be reset to default settings, and you will need to complete the Dockside wizard again.

Selecting a vessel hull type

The Vessel hull type can be accessed from the Pilot Set-up page.

1. Select **Pilot Settings**.
2. Select **Vessel Settings**.
3. Select **Vessel Hull Type**.
4. Select the option that most closely matches your vessel type.

The new selection is applied.

Performing the Dockside wizard

The dockside wizard must be completed before the Evolution autopilot system can be used for the first time. The Dockside wizard guides you through the steps required for commissioning.

The Dockside wizard contains different steps depending on whether you have a rudder reference transducer fitted to your vessel:

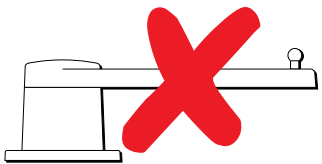
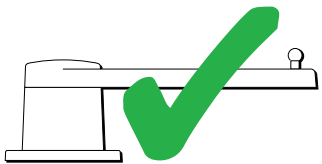
	
<p>The following Dockside wizard procedures only apply to vessels without a rudder reference transducer:</p> <ul style="list-style-type: none"> • Drive Type selection. • Rudder Limit setting. • Hard-over time setting (Raymarine recommends that this information is specified once the dockside wizard and Rudder Drive check is complete, using the Hard Over Time menu option). • Rudder Drive check. 	<p>The following Dockside wizard procedures only apply to vessels with a rudder reference transducer:</p> <ul style="list-style-type: none"> • Drive Type selection. • Align Rudder (rudder alignment). • Rudder Limit setting. • Rudder Drive check.

To access the wizard, ensure the pilot is in **standby** mode and then from the Pilot Set-up page:

1. Select **Pilot Settings**.
2. Select **Commissioning**.
3. Select **Dockside Wizard**.

Selecting a drive type

Drive type selection is available from the dockside wizard, and also from the Vessel settings menu: **Pilot Set-up > Pilot Settings > Vessel Type > Drive type**.

With the **Drive Type** menu displayed:

1. Select your drive type from the list.

Note: The drive types available are dependant on the ACU type. If your drive type is not listed contact your Raymarine dealer for advice.

2. Select **OK** to save your setting and display the next set-up page.

Note: You can cancel the Dockside wizard at any time by selecting **STANDBY**.

Checking the rudder alignment

This procedure establishes port and starboard rudder limits for systems using a rudder reference transducer.

The rudder check forms part of the dockside wizard.

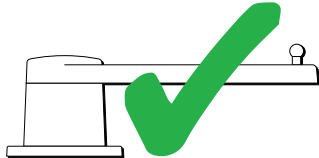
	<p>The following procedure only applies to vessels with a rudder reference transducer.</p>
---	--

1. Center the rudder and select **OK**.
2. When prompted, turn the rudder hard to port and select **OK**.
3. When prompted, turn the rudder hard to starboard and select **OK**.
4. When prompted, turn the rudder back to centre and select **OK**.

Note: You can cancel Dockside wizard at any time by selecting **STANDBY**.

Rudder limit setting

As part of the Dockside wizard, the system will set-up the rudder limits.

- **For vessels with a rudder reference transducer** — This procedure establishes the rudder limit. The rudder limit will be displayed with a message confirming that the rudder limit has been updated. This value can be changed if required.
- **For vessels without a rudder reference transducer** — A default of 30 degrees is displayed, and can be changed as required.

Hard over time

The hard over time setting can be specified as part of the Dockside wizard.

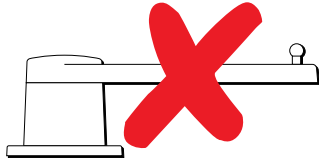
	<p>The following information only applies to vessels without a rudder reference transducer.</p>
--	---

- **If you already know the hard-over time** for your vessel's steering system: enter this time during the Dockside wizard procedure.
- **If you do NOT know the hard-over time** for your vessel's steering system: skip this step during the Dockside wizard by selecting **SAVE**, complete the Dockside wizard procedure. Once the wizard is complete, calculate and adjust the hard-over time.

Checking the rudder drive

As part of the Dockside wizard, the system will check the drive connection. Once it has completed the check successfully, a message will appear asking if it is safe for the system to take the helm.

During this procedure the autopilot will move the rudder. Ensure it is safe to proceed before selecting **OK**.

When in the Dockside wizard, with the Motor Check page displayed:

1. Center and let go of the rudder.
2. Disengage any rudder drive clutch.
3. Select **CONTINUE**.
4. Check it is safe to proceed before selecting **OK**.
For vessels **with** a rudder reference transducer, the autopilot will now automatically move the rudder to port and then starboard.
5. For vessels **without** a rudder reference transducer, you will be asked to confirm the rudder turned to port by selecting **YES** or **NO**.
6. Select **OK** if it is safe to engage the rudder in the opposite direction.
7. You will be asked to confirm the rudder turned to starboard by selecting **YES** or **NO**.
8. Dockside wizard is now complete, select **CONTINUE**.

Note: If you confirmed a "NO" response for the rudder movement to both port and starboard, the wizard will exit. It is possible that the steering system did not move the rudder in any direction, and it will be necessary to check the steering system before completing the Dockside wizard procedure again.

Note: If the rudder moves in the opposite direction than expected you may need to reverse the phase of the rudder reference unit. This can be achieved by accessing: **Pilot Set-up > Pilot Settings > Drive Settings > Reverse Rudder Ref.**

You can cancel Dockside wizard at any time by pressing **STANDBY**.



Warning: Rudder check

If no rudder reference has been fitted you **MUST** ensure that adequate provision is made to prevent the steering mechanism from impacting the end stops.

Adjusting the hard-over time

On vessels **without** a rudder reference transducer, it is important to set the hard-over time limits correctly, to ensure accurate autopilot operation. Hard-over time is the time it takes the vessel's steering system to drive the rudder from full port to full starboard.

Before attempting the following procedure, ensure that you've observed and understood the Rudder check warning provided in this document.

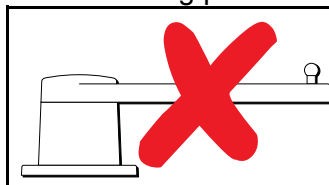

The following information only applies to vessels without a rudder reference transducer.

1. With the autopilot in 'Standby' mode, **manually turn the helm full to port**.
2. Place the autopilot in 'Auto' mode.
3. Using a stopwatch, **start the timer**, and then immediately:
4. Turn 180 degrees from your current heading.
5. Once the rudder has reached the rudder limit that was specified as part of the Dockside wizard, **stop the timer**.
6. To calculate your hard-over time, take the measured time and double it.
7. Now access the **Hard Over Time** menu to specify this hard-over time.

Setting the hard over time

Once the hard over time has been established it can be set following the steps below.

From the Pilot Set-up page:

1. Select **Pilot Settings**.
2. Select **Drive Settings**.
3. Select **Hard Over Time**.
4. Enter your hard over time in seconds.

Compass linearization

With Evolution autopilot systems, when the EV unit is first installed and powered-up, its internal compass needs to compensate for local magnetic variations and the earth's magnetic field. This is achieved using an automatic process known as linearization, which forms an important part of the autopilot installation, commissioning and set-up process.

Linearization

In Evolution systems, the linearization process is performed automatically by the EV unit as a background task when the vessel's speed is between 3 and 15 knots, no user intervention is required however at least a 270 degree turn is required. The process will occur during your first voyage with the autopilot system, and will typically take no more than 30 minutes, but this does vary according to the characteristics of the vessel, the installation environment of the EV unit, and the levels of magnetic interference at the time of conducting the process. Sources of significant magnetic interference may increase the time required to complete the linearization process. Examples of such sources include:

- Marine pontoons.
- Metal-hulled vessels.
- Undersea cables.

Note: You can speed-up the linearization process by completing a 360 degree turn (at a speed of 3 – 15 knots). You can also restart the linearization process at any time by selecting the **Restart Compass** menu item.

Use the compass deviation indicator

The use of the compass deviation indicator on the pilot control head may be useful in this process, particularly if the EV unit has been installed in a location on the vessel where the levels of magnetic interference are too high for the EV unit to compensate appropriately. If this is the case, the deviation display will indicate a value of 25 degrees or higher. In this scenario, Raymarine highly recommends that the EV unit is moved and re-installed in a location which is subject to less magnetic interference. If “- -” is displayed as the Deviation value, it means that linearization has not been successfully completed yet.

Check the compass heading data

As part of the autopilot system commissioning process, Raymarine recommends that you check the compass heading value displayed on your autopilot control head or multifunction display, against a good known heading source on various headings. This will help you to determine when the EV unit has completed its linearization process.

Note: Once the linearization process has completed, it is possible that the heading value may have a slight offset of 2 to 3 degrees. This is common where installation space is limited, and the EV unit cannot be properly aligned to the vessel's longitudinal axis. In this case, it is possible to manually adjust the compass offset value using the pilot control head or multifunction display, and fine-tune the heading to an accurate value.

Note: Do NOT rely on the heading accuracy until you are satisfied that compass linearization and alignment is complete.

System monitoring and adaptation

To ensure optimum performance, after the initial linearization process is complete the EV continues to monitor and adapt the compass linearization to suit current conditions.

If the conditions for linearization are less than ideal, the automatic linearization process temporarily pauses until conditions improve again. The following conditions can cause the linearization process to temporarily pause:

- Boat speed is less than 3 knots.
- Boat speed is greater than 15 knots.
- Rate-of-turn is too slow.
- Significant external magnetic interference is present.

Compass lock











Once you are satisfied with the compass accuracy, you can lock the setting to prevent the autopilot system from completing a further automatic linearization in the future.

This feature is particularly useful for vessels in environments that are exposed to strong magnetic disturbances on a regular basis (such as offshore wind farms or very busy rivers, for example). In these situations it may be desirable to use the Compass lock feature to disable the continuous linearization process, as the magnetic interference may build a heading error over time.

Note: The compass lock may be released at any time, to allow the compass continuous linearization to restart. This is particularly useful if planning a long voyage. The earth's magnetic field will change significantly from one geographical location to another, and the compass can continuously compensate for the changes, ensuring you maintain accurate heading data throughout the voyage.

11.12 Autopilot status symbols

The autopilot status is indicated in the databar.

Symbol	Description
	Autopilot is in Standby mode.
	Autopilot is in Track mode.
	Autopilot is in Auto mode.
	No autopilot detected.
	Autopilot alarm active.
	Dodge mode is active.
	Fish mode is active.
	Autopilot calibration.
	Power steering active.
	Wind Vane mode is active.

11.13 Autopilot alarms

The autopilot function provides alarms to alert you to situations that require action.

Your multifunction display shows autopilot alarms, regardless of whether there is active navigation on the system. If autopilot control is enabled, and an alarm is raised by the autopilot, the multifunction display provides an audible alarm sound (providing that the alarm has not already been silenced). The **Pilot Control** dialog is displayed, indicating a new alarm. Additionally, the autopilot status icon is displayed in red, and remains red until the alarm is cleared.

Silencing autopilot alarms

1. Select **Dismiss**.
The alarm is silenced and the autopilot remains engaged in auto mode, continuing on the current locked heading.
2. Select **Auto**.
The alarm is silenced and the autopilot remains engaged in auto mode, continuing on the current locked heading.
3. Select **Track**.
The alarm is silenced and the autopilot 'tracks' to the next waypoint.

Silencing autopilot alarms and disengaging autopilot

1. Select **STANDBY**.
The alarm is silenced, and the autopilot is disengaged and put in standby mode.

Chapter 12: Alarm management

Chapter contents

- [12.1 Alarms overview on page 166](#)
- [12.2 Alarm Manager overview on page 166](#)
- [12.3 Alarm options on page 169](#)

12.1 Alarms overview

Alarms alert you to a situation or hazard requiring your attention, such as shallow depth or a change in water temperature.

Alarms are triggered by system functions, and external devices connected to the Multifunction display (MFD).

Audible and visual warnings are displayed on all networked MFD screens when an alarm is triggered. The alarm message provides details of the reason for the alarm.

Alarm messages are color coded to signify their severity as follows:

- **Red Alerts** — immediate attention required due to potential or immediate danger to life or vessel. Red Alerts continue to sound until acknowledged or the conditions that triggered the alarm are no longer present. Red Alerts are accompanied by an urgent audible tone.
- **Orange Warnings** — used to warn a user about a change in situation that they need to be aware of. Orange Warnings are accompanied by a normal audible tone.
- **Blue Cautions** — used to inform a user of any other information. Blue Alerts are also used for user acknowledgments and disclaimers. Blue Alerts are not accompanied by an audible tone.

Acknowledging an active alarm

When an alarm event occurs it can be acknowledged by selecting Ok, this will dismiss the alarm message and stop the alarm tone.

During an active alarm event (i.e. an alarm message is displayed):

1. Select **Ok**.

The message is dismissed and the alarm tone is stopped.

Tip If an alarm message includes an **Edit** button then the alarm's settings can be accessed directly from the alarm message.

Most alarms will remain active until the conditions that triggered the alarm are no longer present e.g. a Shallow Depth alarm will automatically dismiss when the depth becomes deeper. Whilst active the alarm will be triggered at a set time interval.

12.2 Alarm Manager overview

The Alarm Manager is used to configure the behavior of alarms and to manage alarm activity.

The Alarm Manager can be used to:

- Enable and disable alarms
- Adjust alarm thresholds
- View alarm history
- View list of currently active alarms

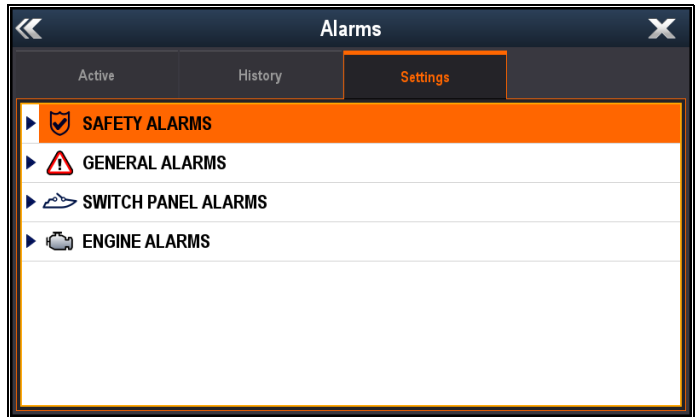

In the **Settings** tab alarms are displayed in the following categories:

- Safety Alarms
- General Alarms
- * Switch Panel Alarms
- ** Engine Alarms

Note:

- * The **Switch Panel Alarms** category is only displayed when you have a correctly configured Raymarine Digital Switching system installed on your vessel.
- ** Engine alarms will only be triggered when the relevant engine data is available on the network and transmitting appropriate NMEA messages.

Alarm Settings

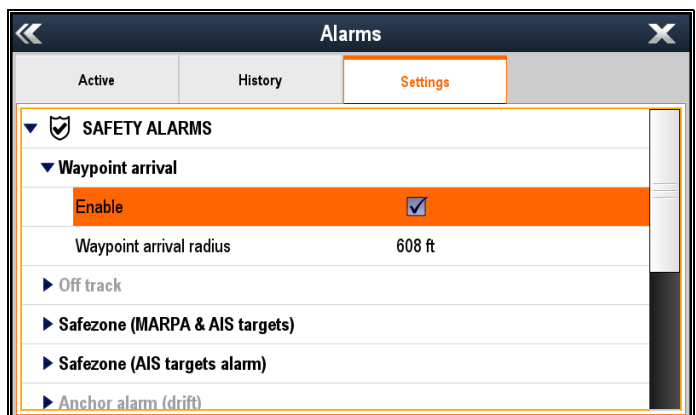

From the **Settings** tab you can enable and disable alarms and change alarm thresholds.

Alarms with Black text are currently enabled, alarms with Gray text are currently disabled. The currently highlighted alarm's text will also be Black.

Alarm History

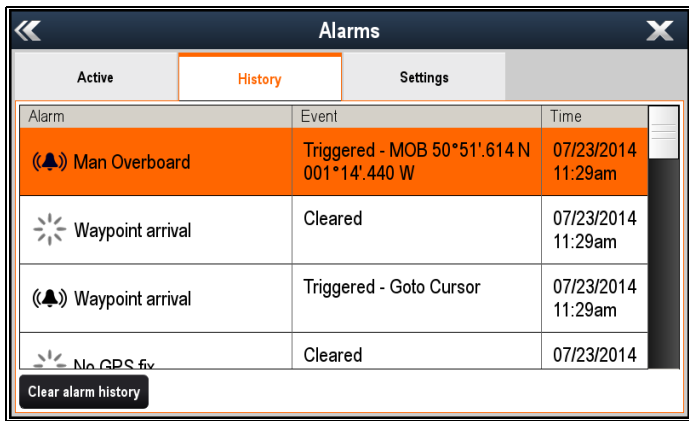

The Alarm History tab provides details of alarms and the date and time that they were triggered and cleared / acknowledged. The Alarm history can display up to 1,000 alarm events and displays them sorted by time.

When the Alarm history has reached its capacity of 1,000 entries, the oldest events in the list will be automatically deleted when subsequent new alarm events occur.

Alarm events will only be removed from the list if:

- **Clear alarm history** is selected.
- a **Systems and Data Reset** is performed.
- it is automatically deleted due to the list reaching its capacity of 1,000 events.

Active Alarms

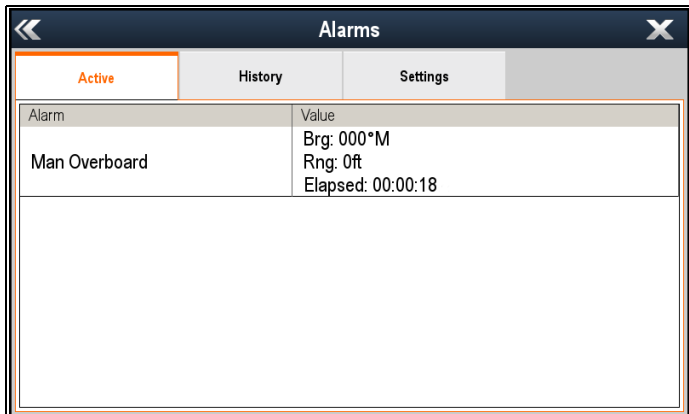

The Active Alarm tab lists all currently active alarms. Alarms are removed from the list when:

- the conditions that triggered the alarm are no longer present.
- the alarm has been disabled.

Accessing the Alarm Manager

From the Homescreen:

1. Select **Set-up**.
2. Select **Alarms**.

The Alarm Manager is displayed.

Enabling and disabling an alarm

You can enable and disable alarms using the Alarm Manager.

From the Alarm Manager **Homescreen > Set-up > Alarms**:

1. Select the **Settings** tab.
2. Select the alarm category for the alarm you want to enable / disable.

Alarms are displayed in the Alarm Manager in the following categories:

- **Safety Alarms**
- **General Alarms**
- * **Switch Panel Alarms**
- **Engine Alarms**

Note: * The **Switch Panel Alarms** category is only displayed when you have a correctly configured Raymarine Digital Switching system installed on your vessel.

3. Select on the relevant alarm.

Alarms with Black text are currently enabled and alarms with Gray text are currently disabled.

The alarm will be expanded to show the alarm settings.

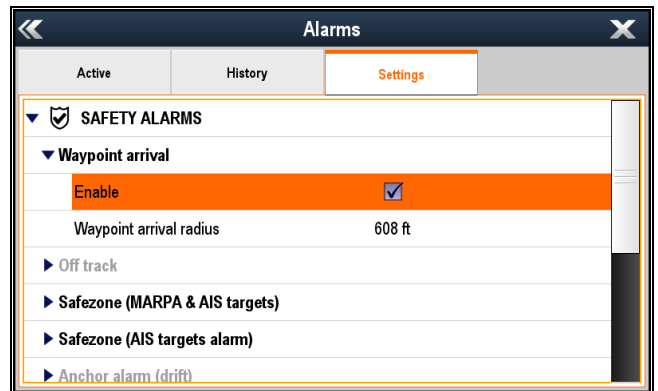

If the **Enable** box is ticked then the alarm is currently enabled.

4. To disable the alarm, select the **Enable** tick box so that the tick is removed.
5. To enable the alarm, select the **Enable** tick box so that a tick is displayed.

Changing alarm thresholds

Alarm thresholds are the attributes associated with each alarm which dictates when the alarm event is triggered.

With the Alarm Manager displayed:

1. Select the **Settings** tab.
2. Select the alarm category for the alarm you want to change the thresholds of.
3. Select on the relevant alarm.
The alarm will be expanded to show the alarm settings.
4. Select the relevant threshold.
The numeric adjustment control is displayed.

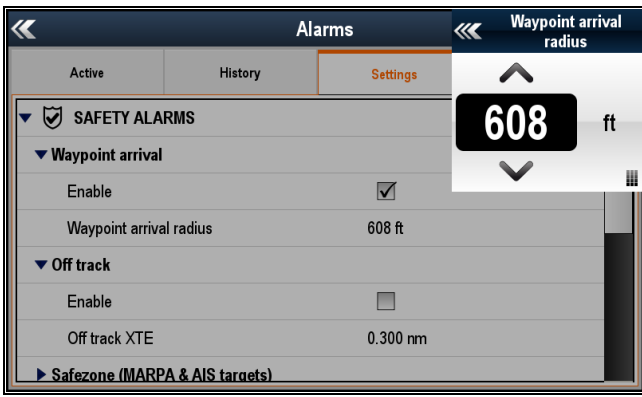

5. Select **Yes**.

The alarm history is deleted.

The alarm history is also cleared if a **Systems and Data Reset** is performed.

5. With the numeric adjust control displayed, select the on-screen **Up** and **Down** arrows to adjust the alarm threshold value, or

6. To use the numeric keypad:

- i. Select on the actual value or the keypad icon. The numeric keypad is displayed.

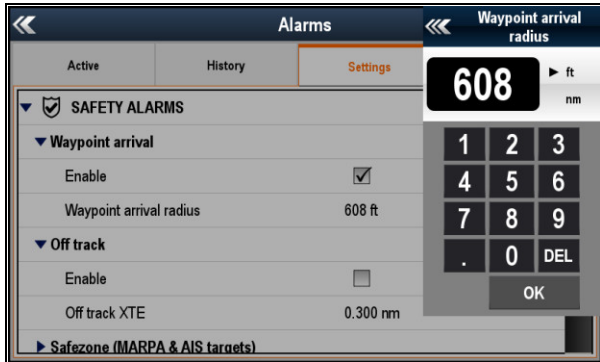

- ii. Use the on-screen keypad to enter the desired value for the alarm threshold.
- iii. Select **OK** to save the new value for the alarm threshold.
- iv. You can also change the unit of measure for the alarm threshold you are currently changing by selecting on the relevant unit of measure from the numeric keypad.

Clearing the alarm history

You can view the history of alarm events from the Alarm Manager.

From the Homescreen:

1. Select **Set-up**.
2. Select **Alarms**.
The Alarm Manager is displayed.
3. Select **History**.
The alarm history is displayed.

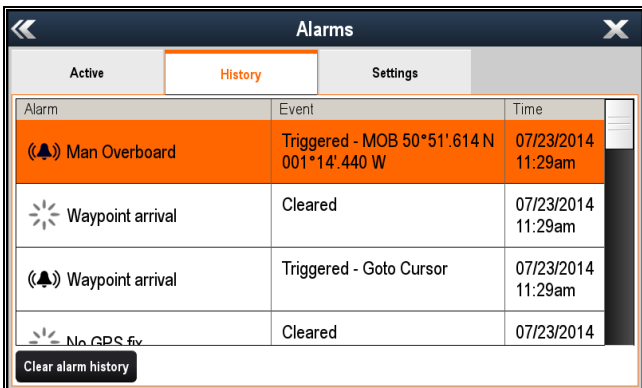

4. Select **Clear alarm history**.
A confirmation message is displayed.

12.3 Alarm options

Safety Alarms

Menu item	Description	Options
Waypoint arrival	<p>If enabled, when you arrive at a waypoint, an alarm is triggered. This setting allows you to specify the radius of the waypoint arrival circle. The waypoint arrival circle is an imaginary circle around the destination waypoint. When your vessel crosses this circle the Waypoint Arrival alarm is triggered.</p> <div style="border: 1px solid black; padding: 5px; margin-top: 10px;"> <p>Note: The waypoint arrival alarm is always enabled if your system includes a Raymarine autopilot.</p> </div>	<p>Enable:</p> <ul style="list-style-type: none"> • Enabled (Ticked) (default) • Disabled (Un-ticked) <p>Waypoint arrival radius Default values:</p> <ul style="list-style-type: none"> • 19 m — applies to km and nm & m units of measure. • 61 ft — applies to Nautical Miles and Statue Miles units of measure. <p>Radius / distance range:</p> <ul style="list-style-type: none"> • 19 to 18,520 m • 61 to 60,761 ft • 0.01 to 10 nm • 0.012 to 11.508 sm • 0.019 to 18.52 km
Off track	<p>When enabled, during active navigation an alarm is triggered when your vessel steers off-track more than the value you specify for the Off Track XTE setting.</p>	<p>Enable:</p> <ul style="list-style-type: none"> • Enabled (Ticked) • Disabled (Un-ticked) (default) <p>Off Track XTE Default values:</p> <ul style="list-style-type: none"> • 556 m — applies to km units of measure. • 0.300 nm — applies to nm and nm & m units of measure. • 0.345 sm — applies to sm units of measure. <p>Radius / distance range:</p> <ul style="list-style-type: none"> • 19 to 18,520 m • 61 to 60,761 ft • 0.01 to 10 nm • 0.012 to 11.508 sm • 0.019 to 18.52 km
Safezone (MARPA & AIS targets)	<p>Alarms are triggered when targets become dangerous. AIS and MARPA targets are deemed dangerous when they are within the specified:</p> <ul style="list-style-type: none"> • Distance / Radius — Closest Point of Approach (CPA), or • Time — Time to Closest Point of Approach (TCPA) <p>to the Safezone MARPA target alarms cannot be disabled. See below for disabling and enabling AIS target alarms.</p>	<p>Safezone radius</p> <ul style="list-style-type: none"> • 0.1 nm / 0.1 sm / 0.2 km • 0.2 nm / 0.2 sm / 0.5 km • 0.5 nm / 0.5 sm / 1 km (default) • 1 nm / 1 sm / 2 km • 2 nm / 2 sm / 5 km <p>Time to Safezone</p> <ul style="list-style-type: none"> • 3 min (default) • 6 min • 12 min • 24 min

Menu item	Description	Options
Safezone (AIS targets alarm)	AIS target alarms can be enabled and disabled. With the AIS target alarm disabled AIS targets will not trigger the Safezone alarm. Triggering of MARPA target alarms cannot be disabled.	Safezone (AIS targets): <ul style="list-style-type: none"> • Enabled (Ticked) (default) • Disabled (Un-ticked)
Anchor alarm (drift)	When enabled, the Anchor Drift alarm is triggered when your vessel drifts from your anchor position by more than the distance specified in the Drift range setting.	Enable: <ul style="list-style-type: none"> • Enabled (Ticked) • Disabled (Un-ticked) (default) Drift range Default values: <ul style="list-style-type: none"> • 185 m / 608 ft Distance range: <ul style="list-style-type: none"> • 19 to 3,047 m • 61 to 9,999 ft • 0.01 to 1.646 nm • 0.012 to 1.894 sm • 0.019 to 3.048 km
Low fuel remaining	<p>If the Fuel Manager is not currently enabled then selecting the Low fuel remaining (LFR) alarm will result in a message being displayed asking if you want to enable the Fuel Manager.</p> <p>The LFR alarm can be enabled and the threshold can be set without the Fuel Manager being enabled, however the alarm will not be triggered until the Fuel Manager is enabled.</p> <div style="border: 1px solid black; padding: 5px; margin-top: 10px;"> <p>Note: You cannot set LFR to be more than the current TFC value.</p> </div>	Enable: <ul style="list-style-type: none"> • Enabled (Ticked) • Disabled (Un-ticked) (default) Fuel level Default value: <ul style="list-style-type: none"> • If Total Fuel Capacity (TFC) has been set in the Fuel Manager then the default shall be 20% of the TFC value. Volume range: <ul style="list-style-type: none"> • 0 to 99,999 ltr / 0 to TFC • 0 to 99,999 Gal / 0 to TFC
DSC	With the DSC alarm enabled, DSC distress calls will be displayed on the screen of all networked MFDs.	DSC Alerts: <ul style="list-style-type: none"> • Enabled (Ticked) (default) • Disabled (Un-ticked)
AIS	With the AIS alarm enabled, AIS safety messages will be displayed on the screen of all networked MFDs.	AIS safety messages: <ul style="list-style-type: none"> • Enabled (Ticked) (default) • Disabled (Un-ticked)
MOB	Determines whether Position or Dead Reckoning (DR) data is displayed. Assuming that your vessel and the MOB are subject to the same tide and wind effects, the Dead Reckoning setting normally gives a more accurate course.	MOB data type <ul style="list-style-type: none"> • Dead Reckoning • Position (default)

General Alarms

Menu item	Description	Options
Alarm Clock	When enabled, an alarm is triggered at the time you specify in the Alarm Clock Time setting.	Enable: <ul style="list-style-type: none"> • Enabled (Ticked) • Disabled (Un-ticked) (default) Alarm Clock Time

Menu item	Description	Options
		<ul style="list-style-type: none"> • 00.00 to 23:59 hrs (hh:mm)
Countdown Timer	<p>When enabled, counts down the time period specified in the Timer Period setting, and triggers an alarm when zero is reached.</p>	<p>Enable:</p> <ul style="list-style-type: none"> • Enabled (Ticked) • Disabled (Un-ticked) (default) <p>Time Period</p> <ul style="list-style-type: none"> • 00:00:01 to 99:59:59 (hh:mm:ss)
Fishing — shallow water arrival	<p>When enabled, an alarm is triggered when the depth reaches the value specified in the Shallow Limit alarm setting. This option is only available when current depth data is available.</p> <div data-bbox="395 555 979 674" style="border: 1px solid black; padding: 5px;"> <p>Note: The Shallow Limit cannot be set to a depth greater than the depth specified for the Deep Limit setting..</p> </div>	<p>Enable:</p> <ul style="list-style-type: none"> • Enabled (Ticked) • Disabled (Un-ticked) (default) <p>Shallow Limit Default values:</p> <ul style="list-style-type: none"> • 1.5 m / 5.0 ft / 0.89 fa (default) <p>Range:</p> <ul style="list-style-type: none"> • 0.6 m to Max depth limit of connected sonar module • 2 ft to Max depth limit of connected sonar module • 0.3 fa to Max depth limit of connected sonar module
Fishing — deep water arrival	<p>When enabled, an alarm is triggered when the depth reaches the value specified in the Deep Limit alarm setting. This option is only available when current depth data is available.</p> <div data-bbox="395 1122 979 1240" style="border: 1px solid black; padding: 5px;"> <p>Note: The Deep Limit cannot be set to a depth less than the depth specified for the Shallow Limit setting..</p> </div>	<p>Enable:</p> <ul style="list-style-type: none"> • Enabled (Ticked) • Disabled (Un-ticked) (default) <p>Deep Limit Default values:</p> <ul style="list-style-type: none"> • 1.5 m / 5.0 ft / 0.89 fa (default) <p>Range:</p> <ul style="list-style-type: none"> • Shallow Limit to 914 m • Shallow Limit to 3,000 ft • Shallow Limit to 500 fa
Water temperature	<p>When enabled, an alarm is triggered when:</p> <ul style="list-style-type: none"> • the water temperature is equal to or less than the temperature specified in the Lower Temp Limit setting, or • the water temperature is equal to or greater than the temperature specified in the Upper Tempo Limit setting. 	<p>Enable:</p> <ul style="list-style-type: none"> • Enabled (Ticked) • Disabled (Un-ticked) (default) <p>Upper Temp Limit Defaults:</p> <ul style="list-style-type: none"> • 23.9°C / 75°F (default) <p>Range:</p> <ul style="list-style-type: none"> • Lower Temp Limit to 37.7°C • Lower Temp Limit to 99.9°F <p>Lower Temp Limit Defaults:</p> <ul style="list-style-type: none"> • 15.6°C / 60°F (default) <p>Range:</p> <ul style="list-style-type: none"> • -23.3°C to Upper Temp Limit

Menu item	Description	Options
		<ul style="list-style-type: none"> • -9.98°F to Upper Temp Limit
Fish	<p>If the Fish alarm is enabled, an alarm tone is triggered if a target is detected that meets the Fish alarm sensitivity.</p> <p>The following options are available under Fish Alarm.</p> <ul style="list-style-type: none"> • Enable — Enables and disables Fish Alarms. • Fish alarm sensitivity — If the Fish alarm is set to On, an alarm is triggered when the fish return strength reaches the sensitivity that you specify. • Fish alarm depth limits — Enables and disables the shallow and deep fish alarm limits. • Fish alarm shallow limit — Specifies the lower value for the Fish alarm depth limits. • Fish alarm deep limit — Specifies the upper value for the Fish alarm depth limits. 	<p>Enable:</p> <ul style="list-style-type: none"> • Enabled (Ticked) • Disabled (Un-ticked) (default) <p>Fish alarm sensitivity</p> <ul style="list-style-type: none"> • Default: 5 • Range: 1 to 10 <p>Fish alarm depth limits:</p> <ul style="list-style-type: none"> • Enabled (Ticked) • Disabled (Un-ticked) (default) <p>Fish alarm shallow limit Default values:</p> <ul style="list-style-type: none"> • 0.6 m / 2 ft / 0.3 fa (default) <p>Range:</p> <ul style="list-style-type: none"> • 0.6 m to Fish alarm deep limit • 2 ft to Fish alarm deep limit • 0.3 fa to Fish alarm deep limit <p>Fish alarm deep limit Default values:</p> <ul style="list-style-type: none"> • 305 m / 1,000 ft / 167 fa <p>Range:</p> <ul style="list-style-type: none"> • Fish alarm shallow limit to 914 m • Fish alarm shallow limit to 3,000 ft • Fish alarm shallow limit to 500 fa

Switch Panel Alarms

Menu item	Description	Options
Switch Panel Alarms	The Switch Panel Alarms section is only displayed when connected to a correctly configured Raymarine Digital Switching system.	<ul style="list-style-type: none"> • Enabled (Ticked) (default) • Disabled (Un-ticked)

Engine Alarms

Menu item	Description	Options
Show alarms for engine errors	When enabled, warning alarms from connected, compatible engine management systems will be displayed on the MFD.	<ul style="list-style-type: none"> • Enabled (Ticked) (default) • Disabled (Un-ticked)
Check engine	<p>The engine alarms listed below can be enabled or disabled using the Alarm Manager</p> <ul style="list-style-type: none"> • Over temperature • Low oil pressure • Low oil level • Low fuel pressure • Low system voltage • Low coolant level • Water flow • Water in fuel 	<ul style="list-style-type: none"> • Enabled (Ticked) (default) • Disabled (Un-ticked)

Menu item	Description	Options
	<ul style="list-style-type: none"> • Not charging • High boost pressure • Rev limit exceeded • EGR system • Throttle position sensor • Emergency stop • Warning level 1 • Warning level 2 • Power reduction • Maintenance needed • Communications error • Sub or secondary throttle • Neutral start protect • Engine shutting down • Unknown error 1 (manufacturer specific error message) • Unknown error 2 (manufacturer specific error message) • Unknown error 3 (manufacturer specific error message) • Unknown error 4 (manufacturer specific error message) • Unknown error 5 (manufacturer specific error message) • Unknown error 6 (manufacturer specific error message) • Unknown error 7 (manufacturer specific error message) • Unknown error 8 (manufacturer specific error message) • Check Transmission • Transmission over temperature • Transmission low oil pressure • Transmission low oil level 	

Chapter 13: Man Overboard (MOB)

Chapter contents

- [13.1 Man overboard on page 176](#)

13.1 Man overboard

If you lose a person or object overboard, you can use the Man Overboard (MOB) function to mark the position that the vessel was at when the MOB function was activated.

The MOB function is available at all times, regardless of which application is running. MOB can be set to Dead Reckoning or Position mode. Dead Reckoning mode will take into consideration the effects of wind and tides. This usually provides a more accurate course. Position mode does not take these factors into account.

To obtain a MOB position, your multifunction display must have a GPS position fix. If you're using dead reckoning, heading and speed data must also be available.

When MOB is **activated**:

- An audible MOB alarm is sounded every 30 seconds until the MOB is cancelled.
- An MOB alarm dialog is displayed until it is acknowledged.

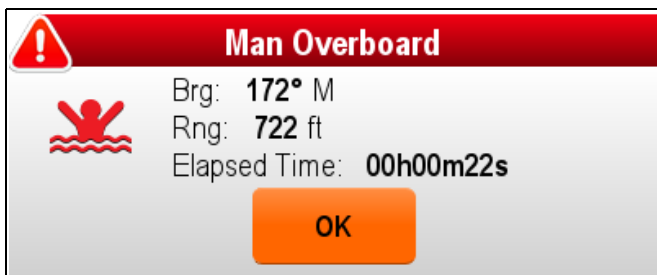

- The system sends MOB alarms to other Raymarine equipment.
- The active Chart application is changed to a low-detail 2D view, with an initial range of 15 m (50 ft). Motion mode is set to Auto Range. As the vessel moves away from the MOB position a dotted line is displayed, joining the MOB position with the vessel's position.

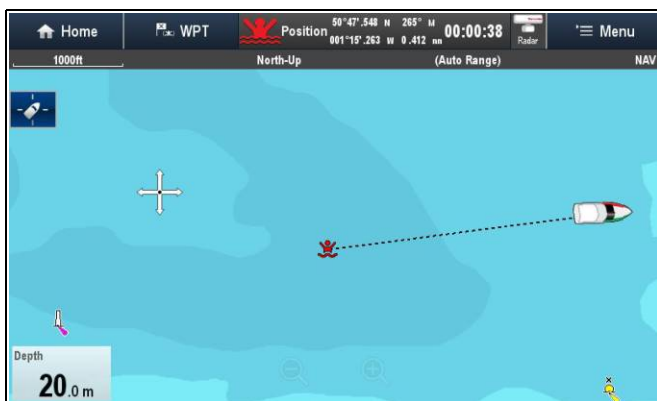

- The active radar application range is changed to 230 m (760 ft).
- All Goto and Follow functions are disabled in all applications. Navigation to any active waypoint is stopped and any existing navigation function is cancelled.
- If position or heading and speed information is available a MOB waypoint is placed at the current vessel position in any application that is capable of showing waypoints and vessel position.

- MOB data is displayed in the databar, replacing the existing data.
- MOB data is displayed on the homescreen, replacing the status icons.



When the MOB alarm is **cancelled**:

- MOB data is removed from the relevant applications.
- The chart application motion mode is reset.
- The chart is centered on the vessel and pitch / rotation set to default.
- GOTO and route functions are restored.
- The databar mode is reset.
- A MOB normal mode signal is sent to any instrument on SeaTalk.

Activating the man overboard (MOB) alarm

On multifunction displays with physical buttons or when using a remote keypad you can use the WPT (MOB) button to activate the MOB alarm

1. Press and hold the **WPT / MOB** button for 3 seconds.



Activating the man overboard (MOB) alarm — Touch only displays

On a Touch only display you can use the onscreen WPT (MOB) icon to activate the MOB alarm

1. Press and hold the onscreen **WPT / MOB** icon for 3 seconds.



Cancelling the man overboard (MOB) alarm — Touch only display

On a Touch only display you can cancel the MOB alarm and resume normal operation follow the steps below:

1. Press and hold the onscreen **WPT / MOB** icon for 4 seconds.

The MOB alarm is cancelled and normal operation is resumed.

Cancelling the man overboard (MOB) alarm

On a multifunction display with physical buttons or when using a remote keypad you can cancel the MOB alarm and resume normal operation follow the steps below:

1. Press and hold the **WPT / MOB** button for 4 seconds.

The MOB alarm is cancelled and normal operation is resumed.

Chapter 14: DSC VHF radio integration

Chapter contents

- [14.1 DSC VHF radio integration on page 180](#)
- [14.2 Enabling DSC VHF radio integration on page 180](#)

14.1 DSC VHF radio integration

You can connect your DSC VHF radio to your multifunction display and show distress message information and GPS position data for other vessels.

Connecting a DSC VHF radio to your multifunction display provides the following additional functionality:

- **Distress Messages** — when your DSC VHF radio receives a DSC message or alarm from another DSC VHF radio, the vessel identification (MMSI), GPS position, and time of distress message is displayed on your multifunction display. With the distress message displayed you can use the buttons provided to: clear the message, place a waypoint on the chart at the GPS position of the distressed vessel, or immediately start navigating (Goto Vessel) to the GPS position of the distressed vessel.
- **Position Data** — the “Position Request” button on your DSC VHF radio enables you to send and receive GPS position data to and from other vessels equipped with a DSC VHF radio.

For information on installing and operating your DSC VHF radio, refer to the handbook that accompanies the radio.

The following image shows an example of a distress message displayed on a multifunction display:



14.2 Enabling DSC VHF radio integration

With the homescreen displayed:

1. Select **Set-up**.
2. Select **System Settings**.
3. Select the **DSC Alerts** option so that On is displayed.

Chapter 15: Fuel manager

Chapter contents

- [15.1 Fuel manager overview on page 182](#)

15.1 Fuel manager overview

The fuel manager provides an estimate of fuel remaining, and the distance and time which can be travelled before the tanks are empty. In order to calculate these values, you must configure the total capacity of fuel available to the engines and log each time you add fuel. The fuel manager also allows you to set a low fuel warning alarm which is sounded when the vessel's estimated fuel falls below a specified value.

The fuel manager page provides current calculation estimates and controls to enable use of the fuel manager feature.

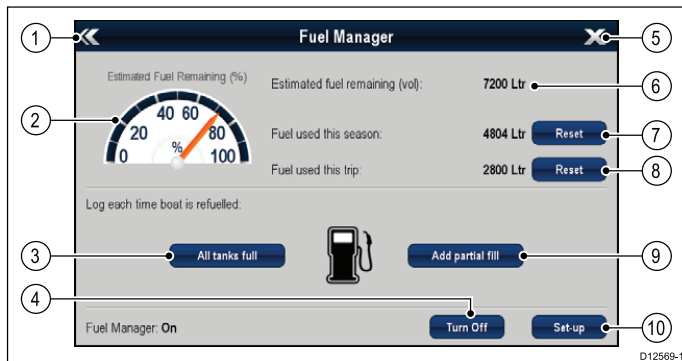

Item	Option	Description
1	Back	Back to System Set-up menu — New e Series only (For New c Series use the Back button).
2	Estimated fuel remaining (%)	Graphical representation of percentage of fuel remaining in the fuel tank(s).
3	All tanks full	Resets fuel remaining to full tank capacity.
4	Turn On/Off	Turn fuel manager On or Off.
5	Close	Back to Homescreen — New e Series only (For New c Series use the Home button).
6	Estimated fuel remaining (vol)	Volume of fuel remaining in the fuel tank(s).
7	Reset (Fuel used this season.)	Reset the fuel used this season to zero.
8	Reset (Fuel used this trip.)	Reset the fuel used this trip to zero.
9	Add partial fill	Specify fill amount by volume
10	Set-up	Specify settings for fuel manager.

In order to use the fuel manager you must:

- Connect a compatible engine interface to each engine you wish to monitor (to provide fuel flow rate data to the network).
- Enter the total fuel capacity of the vessel's fuel tanks.
- Turn on the fuel manager feature.

- Fill the fuel tanks to full.
- Select 'All tanks full'.
- Log each subsequent fuel fill whether partial or full.

Note:

Fuel manager estimates the amount of fuel onboard, based on the user logging each time you fill up, the total fuel capacity, and how much fuel is burned by the engine(s). Any incorrect entry could dramatically affect the estimated fuel usage and capacity which could result in a shortage of fuel. This system is not a substitute for other types of fuel calculations.

Total fuel onboard is an estimate and will be inaccurate if fuel fills are not entered, or fuel is used by other sources (e.g. generators etc.). Estimated distance and time to empty will be based on the fuel remaining calculation and values do not include weather/tide effects.

You should not rely on the fuel manager calculations for accurate voyage planning or in emergency and safety critical situations.

Enabling the fuel manager

To turn the fuel manager on and off follow the steps below.

From the homescreen.

1. Select **Set-up**.
2. Select **Fuel Manager**.
3. Select **Turn On**.

The fuel manager disclaimer is displayed.

4. Select **ACCEPT** to accept the disclaimer and start using the fuel manager.
The Initialize fuel manager pop-up is displayed.
5. Select **OK**.

The fuel manager will start the next time the **All tanks full** icon is pressed.

Disabling the fuel manager

From the fuel manager page:

1. Select **Turn Off**.
The deactivate fuel manager pop-up message is displayed.
2. Select **Yes** to turn off the fuel manager.

Setting up fuel manager

To set up the required settings for the fuel manager follow the steps below.

With the Fuel Manager page displayed:

1. Select **Set-up**.
2. Select **Total Fuel Capacity**.
The numeric keypad is displayed.
3. Enter your vessel's total fuel capacity.
4. Select **Ok**.
5. Select **Economy Units**.
A list of available options is displayed:

- Distance per Volume
 - Volume per Distance
 - Litres per 100km
6. Select the required economy units.
 7. Select **Fuel Calculations** to select the desired method of calculation.

The following options are available:

- Fuel Used (PGN127497)
- Fuel Flow Rate

Note: If the Fuel Used (PGN127497) is not available on your network you will need to use the Fuel Flow Rate option. When Fuel Flow Rate is selected then your multifunction display must remain powered on whilst the engines are running to enable the fuel calculation to be made.

8. Select **Back** to go back to the **Fuel Manager** page.

Fuel logging

You must ensure **all** fuel fills are recorded using the fuel manager.

From the fuel manager page:

1. When filling the tanks until full select **All tanks full**.
The estimated fuel remaining is reset to the value of your fuel tanks capacity.
2. When only partially filling the tank make a note of the volume of fuel added to the tank and then select **Add partial fill**.
3. Enter the value noted earlier this will be added to your current fuel remaining figure.

Note: It is recommended that you perform an 'All tanks full' fill up as regularly as possible as partial fills will cause a higher cumulative inaccuracy in the provided calculations.

Setting the low fuel alarm

Using the fuel manager also allows you to set a low fuel alarm which, if activated, is sounded when your vessel's remaining fuel falls to a specified value.

With the fuel manager turned on and set up correctly:

1. From the homescreen select **Set-Up**.
2. Select **Alarms**.
3. Select **Fuel manager**.
The low fuel alarm settings are displayed.
4. Select **Low Fuel** so that On is highlighted.
Selecting **Low Fuel** will turn the low fuel alarm On or Off.
5. Select **Fuel Level**.
The fuel level numeric adjust control is displayed.
6. Adjust the fuel level to the required value.

The low fuel alarm will now be sounded when the fuel remaining in the tank falls to the value specified.

Note: By default the low fuel alarm is switched off.

Resetting fuel used readings

You can reset the value of the fuel used this season or fuel used this trip by following the steps below.

From the fuel manager page:

1. Select **Reset** against fuel used this season, or
2. Select **Reset** against fuel used this trip.

The value is set to zero after **Reset** has been selected.

Note: Performing a Season reset automatically resets the trip value.

Fuel range rings

The fuel range ring gives an estimated range that can be reached with the estimated fuel remaining on-board.

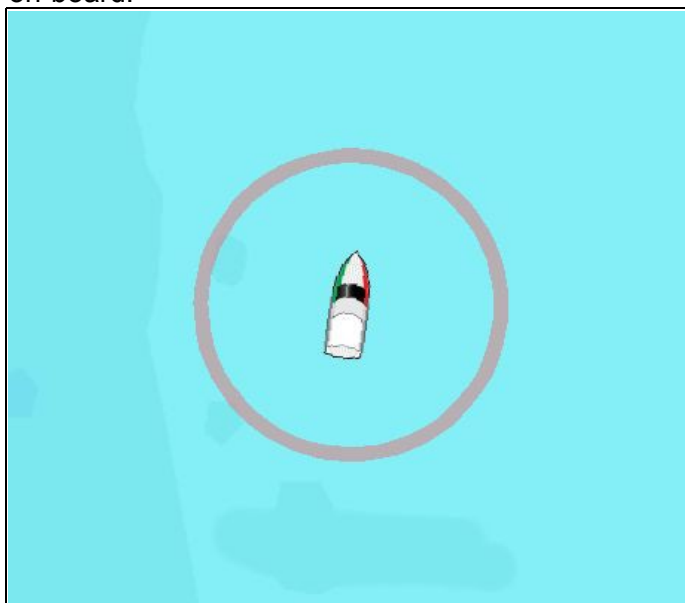

The fuel range ring can be displayed graphically in the chart application and indicates an estimated range that can be reached with the:

- Current rate of fuel consumption.
- Estimated fuel remaining on-board.
- Course remaining in a straight line.
- Current speed maintained.

Note:

The fuel range ring is an estimated range that can be reached at the current rate of fuel consumption, of the fuel onboard and based on a number of external factors which could either extend or shorten the projected range.

This estimate is based on data received from external fuel management devices, or via the Fuel Manager. It does not take into account prevailing conditions such as tide, current, sea state, wind etc.

You should not rely on the fuel range ring feature for accurate voyage planning or in emergency and safety critical situations.

Enabling the fuel range ring

From the chart application, in 2D view:

1. Select **Menu**.

2. Select **Presentation**.
3. Select **Overlays**.
4. Select **Fuel Range Ring** so that On is selected.
The fuel range ring pop-up message is displayed.
5. Select **OK** to turn on the fuel range rings.

Chapter 16: AIS function

Chapter contents

- [16.1 AIS overview on page 186](#)
- [16.2 AIS prerequisites on page 187](#)
- [16.3 AIS context menu on page 187](#)
- [16.4 Enabling AIS on page 188](#)
- [16.5 Displaying AIS vectors on page 188](#)
- [16.6 AIS status symbols on page 189](#)
- [16.7 AIS silent mode on page 189](#)
- [16.8 AIS target symbols on page 190](#)
- [16.9 Displaying detailed AIS target information on page 191](#)
- [16.10 Viewing all AIS targets on page 191](#)
- [16.11 Using AIS to avoid collisions on page 192](#)
- [16.12 Target options on page 193](#)
- [16.13 AIS alarms on page 194](#)
- [16.14 Buddy tracking on page 194](#)

16.1 AIS overview

The AIS feature enables you to receive information broadcast by other vessels, and to add these vessels as targets in the chart and radar applications.

With an optional AIS unit connected to your system you can:

- Display targets for any other AIS-equipped vessels.
- Display voyage information being broadcast by these targets, such as their position, course, speed and rate-of-turn.
- Display basic or detailed information for each target vessel, including safety-critical target data.
- Set up a safe zone around your vessel.
- View AIS alarm and safety-related messages.
- Add AIS-equipped friends and regular contacts to a "Buddy List"

AIS information is displayed in the form of an overlay in the chart and radar applications. Additional data is displayed in a dialog box, for example:

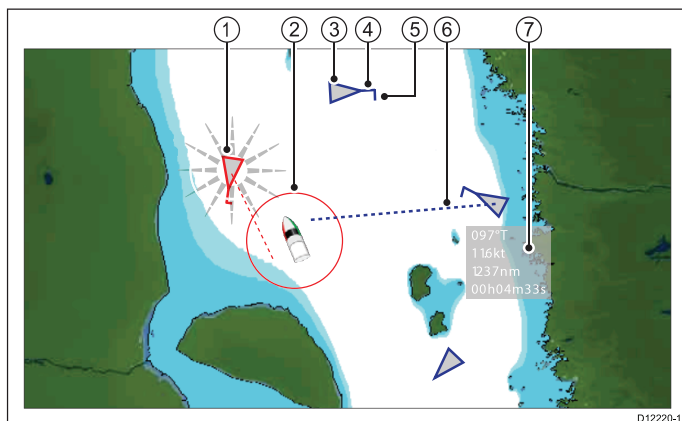

Item	Description
1	Dangerous target (flashes).
2	Safe zone (defined by distance and / or time).
3	AIS target vessel.
4	Heading.
5	Direction of turn.
6	COG/SOG vector.
7	Safety critical data.

AIS-equipped vessels in the surrounding area are displayed in the chart or radar application as triangular targets. Up to 100 targets are displayed. As the vessel's status changes, the symbol for the target changes accordingly.

Vectors can be displayed for each target. These vectors indicate the vessels direction of travel and the distance it will travel over a specified period of time (COG / SOG vector). Targets displayed with their vectors are referred to as 'active targets' and are scaled according to the size of the vessel. The larger the vessel, the larger the target. You can either display all targets or just dangerous targets.

How AIS Works

AIS uses digital radio signals to broadcast 'real-time' information between vessels and shore-based stations via dedicated VHF radio frequencies. This information is used to identify and track vessels in the surrounding area and to provide fast, automatic and accurate collision avoidance data. The AIS features complement the radar application, as AIS can operate in radar blind spots and can detect smaller vessels equipped with AIS.

Note: It may not be mandatory for vessels to be fitted with operational AIS equipment. Therefore, you should not assume that your multifunction display will show ALL vessels in your area. Due prudence and judgement should be exercised. AIS should be used to complement radar, NOT substitute it.

AIS Simulator Mode

Raymarine recommends that you use the simulator function to familiarize yourself with the AIS features. When the simulator function is enabled (**homescreen > Set-up > System Settings > Simulator**), it displays 20 AIS targets within a 25 nm range. These targets are displayed using the appropriate AIS target's status symbol, and move around the screen as if they were real targets.

Note: Incoming safety messages are NOT displayed while the simulator is enabled.

16.2 AIS prerequisites

You must have suitable AIS hardware connected to your multifunction display to make use of the AIS functionality.

In order to run AIS, you will need:

- A receive-only AIS unit or a full AIS transceiver (a unit that sends and receives).
- A VHF antenna.
- A GPS - to provide position data.
- The AIS layer enabled in the chart or radar application, as appropriate.

Note: A receiver will allow you to receive data about other vessels in your area but will not allow other vessels to 'see' you. A full transceiver transmits and receives AIS data, and therefore allows you to receive data about other vessels. It also enables other AIS-equipped vessels to see and receive information about your vessel. This could include position, course, speed and rate of turn data.

When the AIS unit is connected to your multifunction display, the status of the unit is indicated by an AIS icon in the status bar.

You can connect an AIS unit to your multifunction display using NMEA0183 or SeaTalk^{ng}, depending on the AIS unit. If connecting using NMEA0183, you will now need to specify the 38,400 baud setting (**homescreen > Set-up > System Settings > NMEA Set-up**) for the NMEA input port that communicates with the AIS transceiver or receiver.

16.3 AIS context menu

The AIS function includes a context menu which provides AIS target information and menu items.

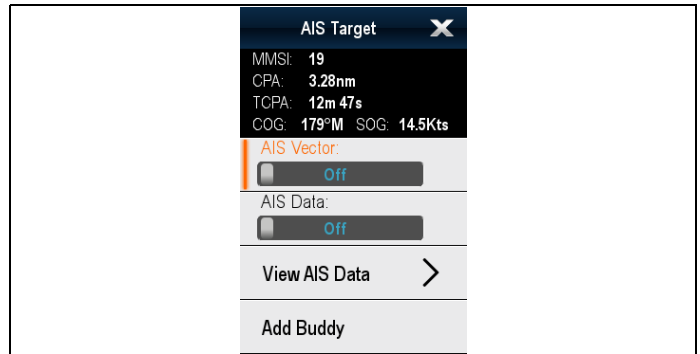

The context menu provides the following AIS target data:

- MMSI
- CPA
- TCPA
- COG
- SOG

The context menu also provide the following menu items:

- **AIS Vector** — Switch target vectors On and Off.
- **AIS Data** — Switch on screen target data On and Off.
- **View Full Data**
- **Add Buddy** — Add target to the buddy directory.
- **Acquire Target** (only available if Radar overlay is switched on.)
- **Slew thermal camera** (only available when thermal camera is connected and operating.)

Accessing the context menu

You can access the context menu by following the steps below.

1. Non-touchscreen and HybridTouch displays:
 - i. Selecting a location, object or target on-screen and pressing the **Ok** button.
2. HybridTouch and Touch only displays:
 - i. Selecting an object or target on-screen.
 - ii. Selecting and holding on a location on-screen.

16.4 Enabling AIS

Enabling AIS in the Chart application

To enable the AIS overlay in the Chart application follow the steps below.

To enable the AIS overlay your system must include an AIS receiver or transceiver. The AIS overlay is not available in 3D view.

From the Chart application menu:

1. Select **Presentation**.
2. Select **Overlays**.
3. Select **AIS**: so that On is selected.
Selecting AIS: switches the AIS between On and Off.

For AIS information refer to [Chapter 16 AIS function](#).

Enabling AIS in the radar application

From the radar application:

1. Select **Menu**.
2. Select **Targets**.
3. Select **Display AIS Targets**.
4. Select the relevant option from the list.

From the **Display AIS Targets** menu you can switch on **All AIS targets**, only **Dangerous AIS targets** or switch AIS targets **Off**.

16.5 Displaying AIS vectors

You must have the correct data available before AIS vectors can be displayed.

A target is defined as active when it has the following data displayed graphically:

- A COG/SOG vector indicating the predicted distance that a target will travel within a given period of time.
- A heading and direction of turn indicator.

Enabling and disabling AIS vectors







From the chart or radar application:

1. Select an AIS target.
The AIS target context menu is displayed.
2. Select **AIS Vector**.
Selecting AIS Vector will switch between On and Off.

Note: The same target vector and safe zone settings apply to both radar MARPA and AIS targets.

16.6 AIS status symbols

AIS status is indicated by a symbol in the databar.

Symbol	Description
	AIS unit is switched on and operating.
	AIS currently unavailable.
	AIS unit is switched off, or not connected.
	AIS unit is in Silent Mode.
	AIS unit is in Silent Mode, with active alarms.
	AIS unit is connected and switched on, but has active alarms.
	AIS unit is connected and switched on, but the dangerous and lost alarm is disabled.

16.7 AIS silent mode

AIS silent mode enables you to disable AIS transmissions

AIS silent mode enables you to disable the transmitting functions of your AIS equipment. This is useful when you do not want to transmit your vessel's AIS data to other AIS receivers, but still wish to receive data from other vessels.

Note: Not all AIS equipment supports silent mode. For more information, refer to the documentation that accompanies your AIS unit.

Enabling and disabling AIS silent mode in the Chart application

From the Chart application:

1. Select **Menu**.
2. Select **AIS Options** or ***Radar & AIS Options**.
3. ****Select Targets**.
4. Select **AIS Set-up**.
5. Select **Silent Mode**.

Selecting Silent Mode will switch AIS silent mode On and Off.

Note:

*When Radar overlay is also enabled the menu name becomes **Radar & AIS Options**.

** Step 3 is only required when Radar overlay is enabled.

Enabling and disabling AIS Silent Mode in the radar application











From the Radar application:

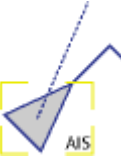
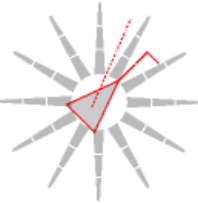

1. Select **Menu**.
2. Select **Targets**.
3. Select **AIS Set-up**.
4. Select **Silent Mode**.

Selecting AIS Silent Mode will switch silent mode On and Off.

16.8 AIS target symbols

Your multifunction display shows a range of symbols to represent the different types of AIS target.

Target type	Description	Symbol
Transmitting target	Target is moving or at anchor (Target is not activated, dangerous or lost).	
Activated target	Target activated — that is, AIS vector displayed. Vector line (optional) shows predicted distance travelled within a given time.	
Selected target	Target selected with cursor. Can view detailed data.	
Dangerous target	Targets within specified distance (CPA) or time (TCPA). Dangerous target alarm sounds if enabled. Target red and flashing.	
Uncertain target	Calculated CPA / TCPA value uncertain.	
Lost target	When the signal of a dangerous target not received for 20 seconds. Target in latest predicted position. Alarms sounds if enabled. Target flashes.	
Buddy target	Target has previously been added to the Buddy List.	
Aid To Navigation (AToN) target (Real)	AToN target is ON position.	
Aid To Navigation (AToN) target (Real)	AToN target is OFF position.	
Aid To Navigation (AToN) target (Virtual)	AToN target is ON position.	
Aid To Navigation (AToN) target (Virtual)	AToN target is OFF position.	
Land base station target	Land base station target is ONLINE.	

Target type	Description	Symbol
Search and rescue transponders (SARTS) target	SARTS target	
Search and rescue aircraft (SARS) target	SARS target	
Military and law enforcement target	Only displayed when connected to approved STEDS-EAIS AIS hardware.	

16.9 Displaying detailed AIS target information

From the chart or radar application:

1. Select an AIS target.
The AIS target context menu is displayed.
2. Select **View AIS Data**.

AIS Data

The table below shows the AIS target information which if available will be displayed on the multifunction display:

- Type
- Status
- Destination
- Last Seen
- ETA
- MMSI
- Call Sign
- IMO No.
- Length
- Beam
- Draught
- Heading
- ROT
- Position
- COG
- SOG
- CPA
- TCPA

Note: Available data is dependant upon what information is being transmitted from the target vessel and the type of AIS unit connected to your system.

16.10 Viewing all AIS targets

- From the Chart application with only the AIS overlay enabled go to: **Menu > AIS Options > Targets > View AIS List**
- From the Chart application when the Radar overlay is also enabled go to: **Menu > Radar & AIS Options > Targets > View Targets Lists > View AIS List**.
- From the Radar application go to **Menu > Targets > View Target Lists > View AIS List**.

No.	MMSI	Range	Bearing	Buddy	Type
12	Sim Target 19	97.0nm	130°P		Unknown
13	Sim Target 16	93.5nm	168°S	✓	Unknown
14	Sim Target 15	101nm	171°S		Unknown
15	Sim Target 1	101nm	169°S		Unknown
16	Sim Target 10	102nm	163°S		Unknown
17	Sim Target 20	102nm	156°S	✓	Unknown

SOG: 10.6Kts Position: 50°45'.378 N
 COG: 083°M : 001°14'.059 E
 ROT: 0°/sec S Heading: 063°M

1. Highlight an AIS target from the list.
When an AIS target is highlighted the following details are displayed in the list:

- MMSI
- Range
- Bearing
- Buddy
- Type

This list can be filtered to show only buddies or all targets.

If available the following data is also shown for the highlighted target:

- SOG
- COG
- ROT
- Position
- Heading

2. To view full AIS target information Select a target from the list and then select **View Full Target Data**.

The AIS target info dialog is displayed showing all available data for the selected target.

AIS Target Info Sim Target 16	
Type: Unknown	Heading: 063°M
Status: Not Defined	ROT: 0°/sec S
Destination: ---	Position: 50°45'.386 N 001°14'.127 E
Last seen: 01/01/2009 01:09:29am	COG: 080°M
ETA: --:--:--	SOG: 10.5Kts
MMSI: 16	CPA: ---nm
Call Sign: ---	TCPA: --h --m --s
IMO No.: -	
Length: ---nm	
Beam: ---nm	
Draft: ---nm	

16.11 Using AIS to avoid collisions

You can use the AIS safe zone and safety message functions to help you avoid collisions with other vessels and objects.

Safe Zones

A safe zone is a ring centred on your vessel within which a target is considered dangerous. It is displayed in the radar or chart applications as a red ring.

This AIS safe zone uses the same criteria as MARPA and will deem a target dangerous if it comes within a specified distance of your vessel (closest point of approach or CPA) within a specified time (time to closest point of approach or TCPA). The CPA and TCPA are calculated using COG/SOG and position from the AIS target.

When your system recognizes a dangerous AIS target:

- The target symbol changes to red and flashes.
- The dangerous alarm dialog is displayed (this can be disabled if required).
- The dangerous alarm sounds (this can be disabled if required).

Note: When the AIS unit is connected and functioning, the system will check for dangerous targets within the safe zone and if enabled issue an alarm whenever necessary. Dangerous target alarm operates irrespective of the status of the AIS target display, or the safe zone ring.

Safety Messages

When the status of the AIS Safety Messages function is set to On, any incoming safety messages from surrounding vessels, shore stations and mobile stations are displayed in a dialog box. If known, the message will include the sending vessel's position in latitude / longitude. You will have the option to:

- Remove the message (**Ok**).
- Place a waypoint on your chart / radar to mark the sending vessel's position (**Place Waypoint**).
- Goto the sending vessel's position (**Goto Waypoint**).

Note: You will NOT receive any safety messages in Simulator mode (**homescreen > Set-up > System Settings > Simulator**).

Showing the Safe Zone Ring in the Chart application

To show the Safe Zone ring follow the instructions below:

From the Chart application:

1. Select **Menu**.
2. Select **Presentation**.
3. Select **Overlays**.
4. Select **Safe Zone Ring** so that **Show** is selected.
Selecting Safe Zone Ring will switch the zone ring between hidden to visible.

Showing the Safe Zone Ring in the Radar application

To show the Safe Zone ring follow the instructions below:

From the Radar application:

1. Select **Menu**.
2. Select **Presentation**.
3. Select **Safe Zone Ring** so that **Show** is selected.
Selecting Safe Zone Ring will switch the zone ring between hidden to visible.

Enabling and disabling AIS safety messages in the Chart application

From in the Chart application:

1. Select **Menu**.
2. Select **AIS Options** or ***Radar & AIS Options**.
3. ****Select Targets**.
4. Select **AIS Set-up**.
5. Select **Safety Messages**.
Selecting Safety Messages will switch between safety messages On and Off.

Note:

*When Radar overlay is also enabled the menu name becomes **Radar & AIS Options**.

** Step 3 is only required when Radar overlay is enabled.

Enabling and disabling AIS safety messages in the radar application

From in the radar application:

1. Select **Menu**.
2. Select **Targets**.
3. Select **AIS Set-up**.
4. Select **Safety Messages**.
Selecting Safety Messages will switch between safety messages On and Off.

Displaying safety-critical AIS information

From the chart or radar application:

1. Select the AIS target.
The AIS target context menu is displayed.
2. Select **AIS Data** so that On is highlighted.
Selecting AIS Data will switch between AIS data On and Off.

The Safety critical AIS data will now be displayed next to the target in the application.

16.12 Target options

The Target options menu for the Chart application and Radar application are shown below.

Parameter	Description	Options
Vector Length	The length of the vector lines displayed depends on the distance that an AIS target travels in the time period that you specify for this setting.	<ul style="list-style-type: none">• 0.5 min• 1 min• 3 min• 6 min• 12 min• 30 min• 60 min
Target History	Targets' previous position will be plotted as a target icon with lighter shading than the actual target for the time specified.	<ul style="list-style-type: none">• Off (default)• 0.5 min• 1 min• 3 min• 6 min

16.13 AIS alarms

The AIS functions generate a number of alarms to alert you to dangerous or lost targets.

In addition to the dangerous target alarm, the system generates an alarm when a dangerous target becomes a lost target i.e. its signal has not been received for 20 seconds.

Your AIS receiver generates local alarms which are displayed and sounded on your multifunction display whenever an alarm condition exists on the unit.

Local AIS alarms

When the connected AIS unit generates an alarm, your multifunction display shows a local alarm message and indicates the alarm status in the status bar.

Active AIS alarms log

The active alarm log shows the status of each local alarm. This log can be accessed as follows:

- from the Chart application when only the AIS overlay is enabled by going to: **Menu > AIS Options > AIS Set-up > AIS Alarms Log**
- from the Chart application when the Radar overlay is also enabled by going to: **Menu > Radar & AIS Options > Targets > AIS Set-up > AIS Alarms Log**
- from the Radar application by going to **Menu > Targets > AIS Set-up > AIS Alarms Log**.

Acknowledging AIS alarms

In the chart or radar application:

1. Select **Ok** on the alarm dialog box.

Note: An AIS alarm remains active until it is acknowledged on your multifunction display.

16.14 Buddy tracking

The Buddy Tracking feature enables you to add AIS-equipped friends and regular contacts to a “Buddy List” on your multifunction display. As soon as a vessel on your Buddy List sails into the range of your AIS unit, the vessel icon changes to indicate this.

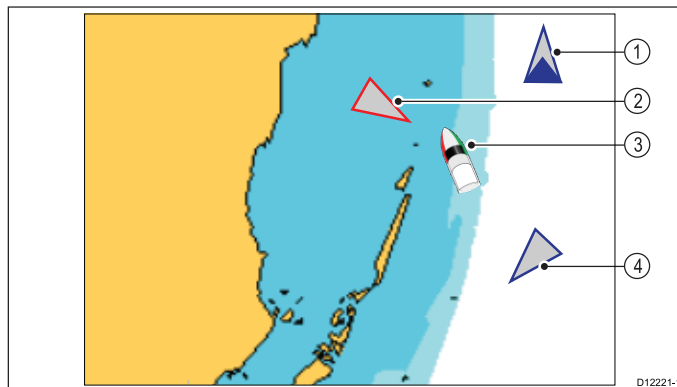

Item	Description
1	Buddy icon
2	Dangerous target icon
3	Own vessel icon
4	Normal AIS icon

How it works

When the AIS Layer is enabled in the chart or radar application, AIS targets are shown on your display. You can add any AIS target to a “Buddy List”, each entry consisting of an MMSI number, and an optional name. Subsequently, whenever Buddy Tracking is enabled on your multifunction display, and a “Buddy” vessel with an MMSI number sails into the range of your AIS receiver, an AIS Buddy icon is displayed. Up to 100 vessels may be added to the Buddy List.

Pre-requisites

The following items are required for the Buddy Tracking feature:

- For the purposes of using the Buddy Tracking feature, it is assumed that your display is already connected to a suitable AIS unit.
- Only transmitting AIS-equipped vessels will be detected.

Enabling and disabling buddy tracking in the Chart application

From the Chart application, with the AIS overlay enabled:

1. Select **Menu**.
2. Select **AIS Options** or ***Radar & AIS Options**.
3. Select **Targets**.
4. Select **Display buddies**.

Selecting Display buddies will switch the buddy tracking feature On and Off.

Note:

*When Radar overlay is also enabled the menu name becomes **Radar & AIS Options**.

Enabling and disabling buddy tracking in the radar application

From the radar application, with AIS enabled:

1. Select **Menu**.
2. Select **Targets**.
3. Select **Display buddies**.
Selecting Display buddies will switch the buddy tracking feature On and Off.

Adding a vessel to your buddy list

In the chart or radar application:

1. Select the AIS target.
The AIS target context menu is displayed.
2. Select **Add Buddy**.
 - i. Select **Yes** to enter a name for the buddy vessel
 - ii. Select **No** to save the vessel to your buddy list without entering a name for the buddy vessel.

The vessel will now be added to your buddy directory.

Adding an AIS buddy from the AIS target list

The AIS target list can be accessed from:

- the Chart application with only the AIS overlay enabled: **Menu > AIS Options > Targets > View AIS List**.
- the Chart application with the Radar and AIS overlays enabled: **Menu > Radar & AIS Options > Targets > View Target Lists > View AIS List**.
- the Radar application: **Menu > Targets > View Target Lists > View AIS List**

From the AIS list:

1. Select an AIS target.
2. Select **Add Buddy**.
 - i. Select **Yes** to enter a name for the buddy vessel
 - ii. Select **No** to save the vessel to your buddy list without entering a name for the buddy vessel.

The vessel will now be added to your buddy directory.

Editing a buddy's details

From the chart or radar application:

1. Select the AIS buddy target.
The AIS buddy context menu is displayed.
2. Select **View Buddy List**.
3. Select the buddy you wish to edit.
The Buddy options dialog is displayed.
4. To change the MMSI number select **Edit Buddy MMSI** or.
The MMSI number must be 9 digits.
5. Select **Edit Buddy Name** to change the buddy name.
This could be the name of the vessel, or the name of the friend who owns the vessel, for example
6. Enter the new details and select **SAVE**.
You will be returned to the buddy list.

Deleting a buddy

From the chart or radar application:

1. Select the AIS buddy target.
The AIS buddy context menu is displayed.
2. Select **Remove Buddy**.
3. Select **Yes** to confirm.
The buddy has now been removed from the list.

The buddy list can also be accessed from:

- the Chart application with only the AIS overlay enabled: **Menu > AIS Options > AIS Options > Targets > View Buddy List**.
- the Chart application with the Radar and AIS overlays enabled: **Menu > Radar & AIS Options > Targets > View Target Lists > View Buddy List**.
- the Radar application: **Menu > Targets > View Target Lists > View Buddy List**.

Displaying additional buddy information

From the chart or radar application:

1. Select the AIS buddy target.
The AIS buddy context menu is displayed.
2. Select **Buddy Data** so that On is highlighted.
Selecting Buddy Data will switch data between On and Off.

The Buddy MMSI and Name will now be displayed next to the buddy icon.

Chapter 17: Waypoints, Routes and Tracks

Chapter contents

- [17.1 Waypoints overview on page 198](#)
- [17.2 Routes on page 207](#)
- [17.3 Tracks on page 215](#)
- [17.4 Import and Export on page 217](#)
- [17.5 Waypoints, routes and tracks storage capacity on page 217](#)

17.1 Waypoints overview

Waypoints are position markers used for the purposes of navigation. Your multifunction display can create waypoints, which can then be selected for active navigation.

There are a range of features for placing, navigating and managing waypoints, these can be accessed from the Waypoints menu and Waypoint context menu. Waypoints are represented on-screen using customizable waypoint symbols. Waypoint can be created, moved, deleted, exported to memory card or imported from a memory card.

Waypoint display examples

Waypoints in the chart application

In the chart application both active and inactive waypoints are shown. An active waypoint is the one that you are navigating to.

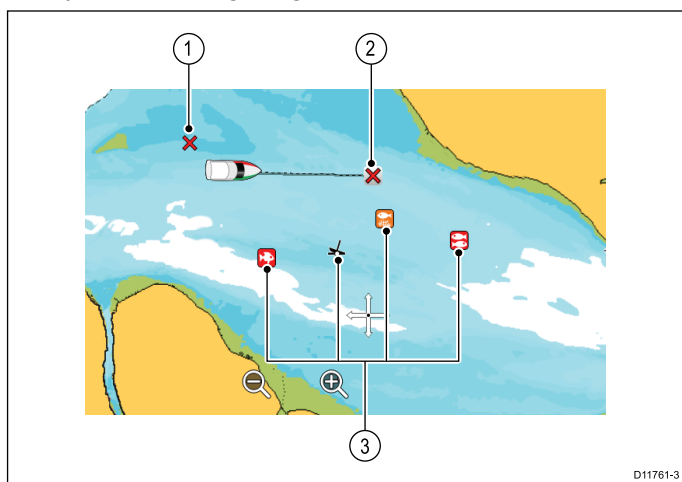

D11761-3

Item	Description
1	Inactive waypoint
2	Active waypoint
3	Alternative waypoint symbols

The default waypoint symbol is a red 'X'. Alternative symbols can be used if required.

Waypoints in the radar application

In the radar application both active and inactive waypoints are shown. An active waypoint is the one that you are navigating to.

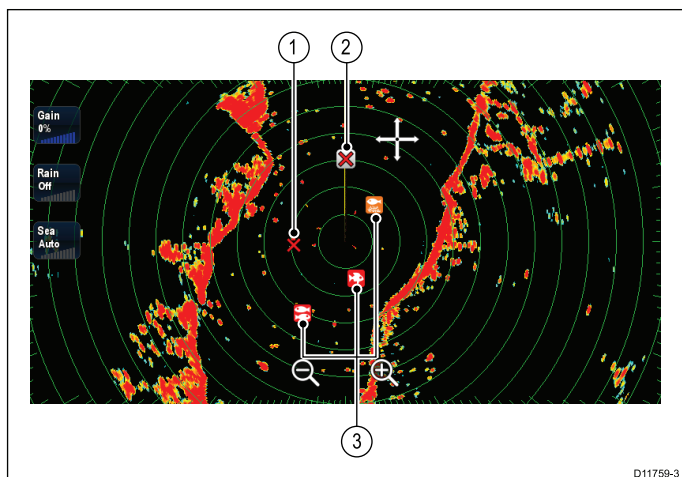

D11769-3

1. Inactive waypoint

2. Active waypoint

3. Alternate waypoint symbols

The default waypoint symbol is a red 'X'. Alternative symbols can be used if required.

Waypoints in the fishfinder application

Waypoints in the fishfinder application are represented by a vertical line labelled WPT.

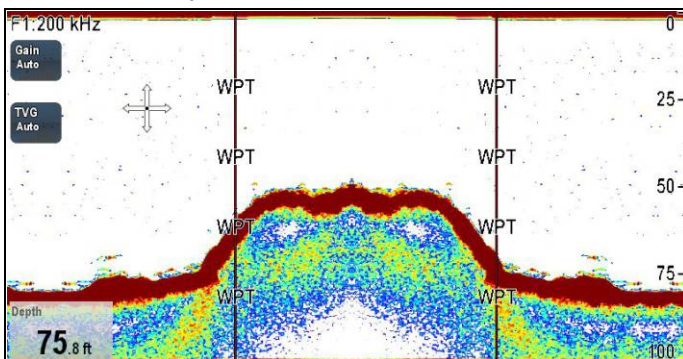

Waypoint (MOB) button / icon

Depending on the multifunction display variant there will be either a Waypoint (MOB) button or an on-screen icon.

WPT button		<ul style="list-style-type: none"> c Series e Series RMK-9 keypad
WPT icons		<ul style="list-style-type: none"> a Series gS Series

Throughout this manual the term: Select **WPT**, refers to pressing the physical **WPT** button or pressing the on-screen **WPT** icon.

Waypoint context menu

Placing the cursor over a waypoint in the chart or radar applications displays a context menu showing the waypoint's positional data and menu items.

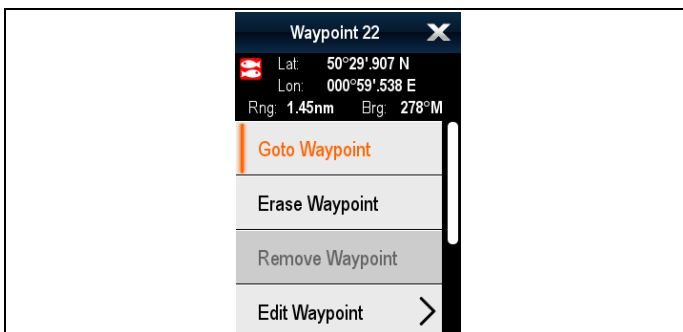

The context menu provides the following positional data for the waypoint in relation to your vessel:

- Latitude
- Longitude
- Range
- Bearing

For inactive waypoints the following menu items are available:

- **Goto Waypoint**
- **Follow From Here** (only available when waypoint is part of a route.)
- **Edit Waypoint**
- **Erase Waypoint**
- **Remove Waypoint** (only available when waypoint is part of a route.)
- **Move Waypoint**
- **Measure**
- **Build Route**
- **Acquire Target** (only available if Radar overlay is switched on.)
- **Slew thermal camera** (only available when thermal camera is connected and operating.)

For active waypoints the following menu items are available:

- **Stop Goto**
- **Restart XTE**
- **Advance Waypoint**
- **Measure**
- **Build Route**
- **Acquire Target** (only available if Radar overlay is switched on.)
- **Slew thermal camera** (only available when thermal camera is connected and operating.)

Accessing the context menu

You can access the context menu by following the steps below.

1. Non-touchscreen and HybridTouch displays:
 - i. Selecting a location, object or target on-screen and pressing the **Ok** button.
2. HybridTouch and Touch only displays:
 - i. Selecting an object or target on-screen.
 - ii. Selecting and holding on a location on-screen.

Waypoint placement

Placing a waypoint

You can place a waypoint on a multifunction display with a touchscreen by following the steps below.

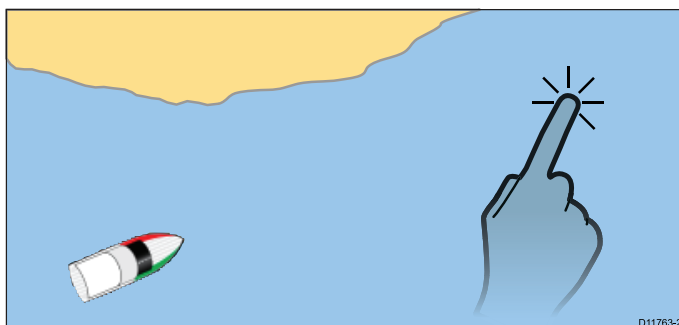

From the chart, radar or fishfinder application:

1. Select and hold the required location on screen.
The context menu is displayed.

2. Select **Place Waypoint**.

The Waypoint Saved dialog is displayed.



3. Select the **Symbol field** to change the symbol that will be used to display the waypoint in the Chart or Radar application.
4. Select the **Name field** to change the name of the waypoint.
5. Select the **Group field** to change the group that the waypoint is assigned to.
6. Select **OK** to confirm the waypoint details.

Note: If there is no user interaction with the Waypoint saved dialog for approximately 5 seconds then the waypoint is saved with the default settings and the dialog is closed automatically.

Placing a waypoint

From the chart, radar or fishfinder application:

1. Position the cursor at the required position.
2. Press the **WPT** button.
The context menu is displayed.
3. Select **Place Waypoint**.
The Waypoint Saved dialog is displayed.



4. Select the **Symbol field** to change the symbol that will be used to display the waypoint in the Chart or Radar application.
5. Select the **Name field** to change the name of the waypoint.
6. Select the **Group field** to change the group that the waypoint is assigned to.
7. Select **OK** to confirm the waypoint details.

Note: If there is no user interaction with the Waypoint saved dialog for approximately 5 seconds then the waypoint is saved with the default settings and the dialog is closed automatically.

Placing a waypoint at your vessel's position

In addition to positional information, a waypoint placed at the vessel position will capture temperature and sounded depth information (if you have the appropriate sensors connected to your system).

From the chart, radar or fishfinder application:

1. Select **WPT**.
The waypoint menu is displayed.
2. Select **WPT** again or select **Place Waypoint At Vessel** from the menu.

The Waypoint Saved dialog is displayed.



3. Select the **Symbol** field to change the symbol that will be used to display the waypoint in the Chart or Radar application.
4. Select the **Name** field to change the name of the waypoint.
5. Select the **Group** field to change the group that the waypoint is assigned to.
6. Select **OK** to confirm the waypoint details.

Note: If there is no user interaction with the Waypoint saved dialog for approximately 5 seconds then the waypoint is saved with the default settings and the dialog is closed automatically.

Placing a waypoint at a known position

You can place a waypoint at a specified location using latitude and longitude coordinates:

1. Select **WPT**.
2. Select **Place Waypoint At Lat/Lon**.
The waypoint details dialog is displayed.

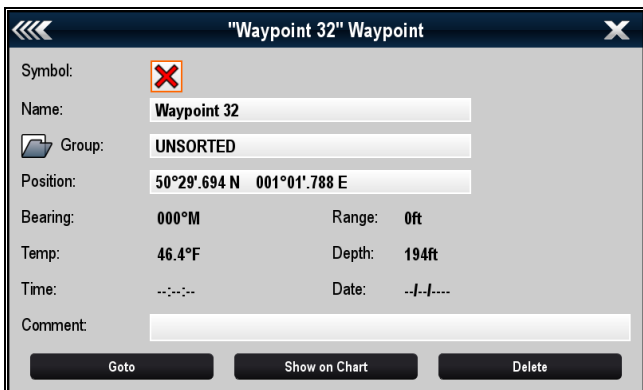

3. Select the **Position** field.
4. Enter the Latitude/Longitude position.
5. Select **SAVE**.
6. You can also edit the waypoint symbol, name and group by selecting the relevant fields.

7. Select **Close** or **Back** to close the dialog.

Waypoint groups

Waypoints are organized into groups. By default all waypoints are placed in the "UNSORTED" group.

New waypoint groups can be created and each waypoint can be assigned to a waypoint group. For example; you could create a waypoint group called "Fishing" and place all of your waypoints where you caught fish into that group.

Waypoint groups can be managed from the Waypoint groups list.

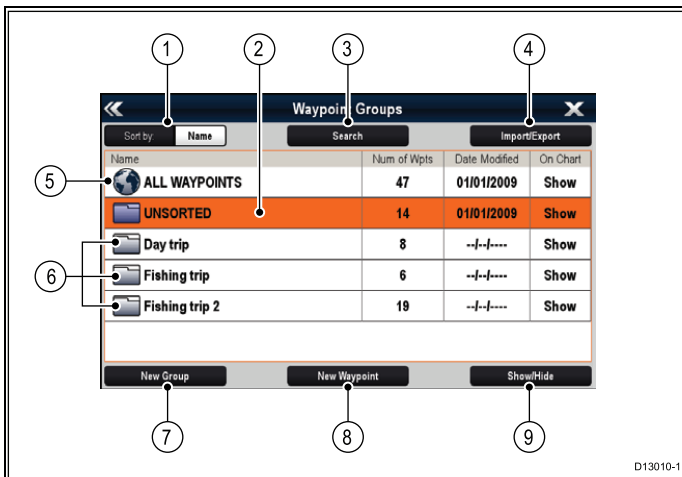

1. **Sort By:** — Waypoint groups can be sorted by name or by date by selecting the **Sort By:** field.
2. **Unsorted** — By default new waypoints are added to the **UNSORTED** waypoint group. Selecting the group will display a list of all waypoints that have not been assigned to a specific group.
3. **Search** — You can search for waypoints using keywords by selecting **Search**.
4. **Import/Export** — Waypoints can be exported to or imported from a microSD card by selecting **Import/Export**. Refer to [8.4 Saving user data and user settings](#) for details.
5. **All waypoints** — Selecting **ALL WAYPOINTS** displays a list of all waypoints saved on your system.
6. **Waypoint Groups** — All waypoint groups are displayed in the list.
7. **New Group** — A new waypoint group can be added by selecting **New Group**.
8. **New Waypoint** — New waypoints can be added manually by selecting **New Waypoint**.
9. **Show/Hide** — You can choose which waypoint groups are displayed and which groups are hidden by selecting the relevant group from the list and then selecting **Show/Hide**.

Selecting a waypoints group from the list displays a list of all waypoints in that group. Additional functions are available to help manage your waypoints.

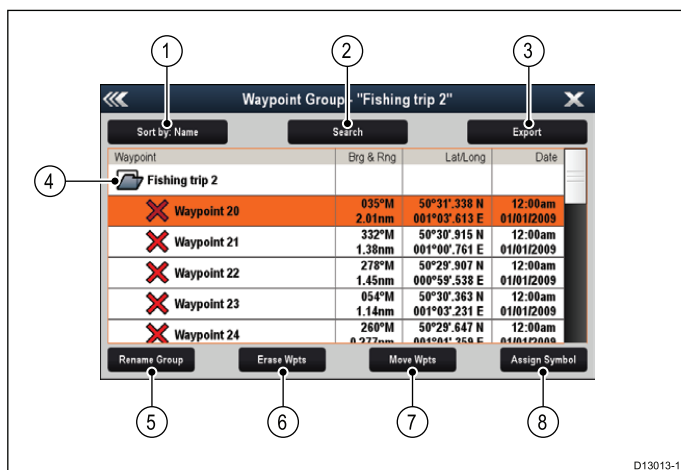

1. **Sort By:** — Sort waypoints by Name, Range, Symbol or Date.
2. **Search** — Search for waypoints using keywords.
3. **Export** — Exports the waypoint group currently displayed to a memory card.
4. **Waypoint group** — This is the currently selected waypoint group.
5. **Rename Group** — Rename the current group.
6. **Erase Wpts** — Erase all waypoints in the group.
7. **Move Wpts** — Move all waypoints in the group.
8. **Assign Symbol** — Assign a new symbol to all waypoints in the group.

Displaying the waypoint group list

From any application:

1. Select **WPT**.
2. Select **Waypoints**.
The waypoint group list is displayed.

Making a new waypoint group

With the Waypoint Group List displayed:

1. Select **New Group**.
The on-screen keyboard is displayed.
2. Use the on-screen keyboard to enter the required name for the new group.
3. select **SAVE**.

Renaming a waypoint group

With the Waypoint group list displayed:

1. Select the group you want to rename.
Group details are displayed.
2. Select **Rename Group**.
The on-screen keyboard is displayed.
3. Using the on-screen keyboard change the group name as required.
4. Select **SAVE**.

Assigning a new symbol to a waypoint group

You can assign a new waypoint symbol to all the waypoints in a group.

From the Waypoint group list:

1. Select the group that you want to assign a new waypoint symbol to.
A group details list is displayed showing all waypoints in the selected group.

2. Select **Assign Symbol**.

A list of all available symbols is displayed.

3. Select the symbol that you want to use for the waypoints in the selected group.

A confirmation dialog is displayed.

4. Select **Yes** to apply the new symbols to the waypoints, or select **No** to **cancel**.

Moving a waypoint to a different group

With the Waypoints group list displayed:

1. Select **ALL WAYPOINTS**.

A list of all waypoints currently on your system is displayed.

2. Select the waypoint you want to move.
The waypoint details page is displayed.
3. Select the **Group** field
A list of all groups is displayed.
4. Select the **Group** that you want to move the waypoint to, or
5. Select **Create New Group** to move the waypoint to a new group.

The waypoint is moved to the selected group.

Moving all waypoints in a group to a different group

You can move all waypoints in a group to a different group.

With the Waypoints group list displayed:

1. Select the Group that contains the waypoints you want to move.
2. Select **Move Wpts**.
A list of all groups is displayed.
3. Select the group from the list that you want to move the waypoints too.
A confirmation dialog is displayed.
4. Select **Yes** to move the waypoints or **No** to cancel.

The waypoints have now been moved to the new group.

Erasing all waypoints in a group

You can erase all waypoints in a selected group.

With the waypoint groups list displayed:

1. Select the group that contain the waypoints you want to erase.
A list is displayed showing all waypoints in the selected group.
2. Select **Erase Wpts**.
A confirmation dialog is displayed.
3. Select **Yes** to erase all waypoints in the group, or **No** to cancel.

All of the waypoints in the selected group are erased from the system and the group will now be empty.

Erasing a waypoint group

Before you can erase a waypoint group you must move or erase all the waypoints assigned to that group.

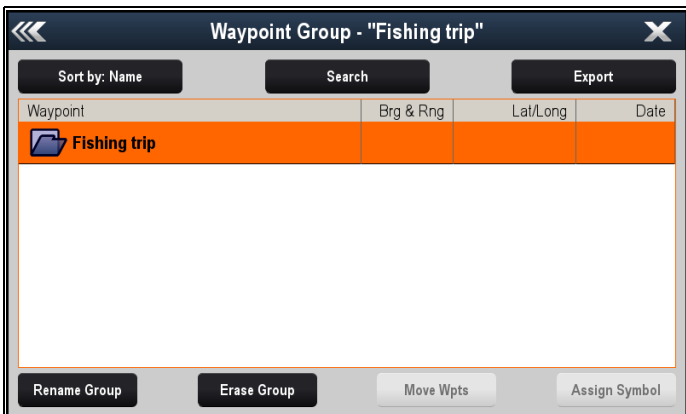

With the Waypoint Group displayed:

1. Select the waypoint group that you want to erase.
2. Select **Erase Group**.
The group is deleted from the system.

Waypoint information

When you create a waypoint, the system assigns information regarding the location marked. You can view and edit the details of any waypoint that has been created and stored.

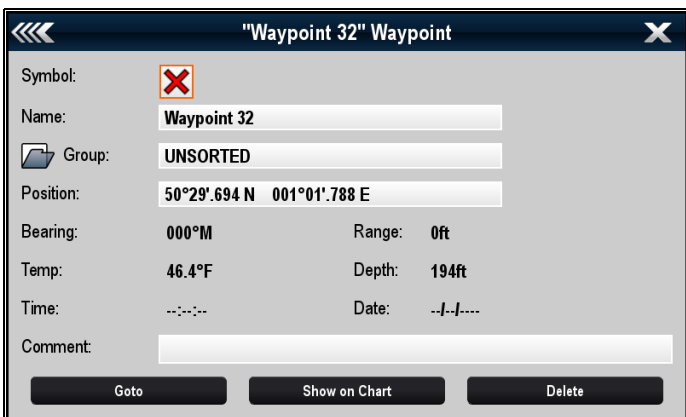

The following information is assigned or captured for each waypoint:

- **Symbol** (a default symbol is assigned, or you can select an alternative.)
- **Name** (a default name is assigned, or you can select an alternative.)
- **Position** (Latitude and Longitude of the waypoint.)
- **Bearing** and **Range** (Bearing and range from vessel.)
- **Temperature** (requires appropriate sensor, only for waypoints captured at the vessel position.)
- **Depth** (requires appropriate sensor, only for waypoints captured at the vessel position.)
- **Date and time**
- **Comment** (you can add your own text comments to a waypoint.)

From the waypoint information page you can also perform the following actions:

- **Goto** (Start active navigation to the waypoint.)

- **Show on Chart** (Show the waypoint location in the chart application.)
- **Delete** (Delete the waypoint from the waypoints list.)

Displaying the waypoint list

From any application:

1. Select **WPT**.
2. Select **Waypoint List**.
The waypoint list is displayed.

Note: The waypoint list can also be accessed directly from the Homescreen by selecting **WPT**, or by going to the **My Data** menu and selecting **Waypoint List**.

Editing waypoint details

With the Waypoint List displayed:

1. Select the waypoint you want to edit.
The waypoint information page is displayed.
2. Select the field you want to edit.
3. Use the on-screen keyboard to make the changes, then select the on-screen keyboard's **SAVE** button.

Editing a waypoint using the context menu

With the application page displayed:

1. Select the waypoint symbol on-screen.
The waypoint context menu is displayed.
2. Select **Edit Waypoint**.
The edit waypoint dialog is displayed.
3. Select the field you want to edit.
4. Use the on-screen keyboard to make the changes, and then select the on-screen keyboard's **SAVE** key.

Moving waypoints

Moving a waypoint using the context menu

With the application page displayed:

1. Select the waypoint symbol on-screen.
The waypoint context menu is displayed.
2. Select **Move Waypoint**.
3. Select the new position for the waypoint.

Moving a waypoint by entering new coordinates

With the Waypoint List displayed:

1. Select **All Waypoints**.
2. Select the relevant waypoint.
The waypoint information page is displayed.
3. Select the Position field.
4. Use the on-screen keyboard to make the changes, and then select the on-screen keyboard's **SAVE** key.

Erasing waypoints

Erasing a waypoint using the context menu

With the application page displayed:

1. Select the waypoint symbol on-screen.
The waypoint context menu is displayed.

2. Select **Erase Waypoint**.
The erase waypoint pop up message is displayed.
3. Select **Yes** to confirm, or **No** to cancel.

Erasing a waypoint using the waypoint list

With the Waypoint List displayed:

1. Select **All Waypoints**.
The waypoint information page is displayed.
3. Select **Erase**.
The erase waypoint pop up message is displayed.
4. Select **Yes** to confirm, or **No** to cancel.

Erasing all waypoints

From the homescreen:

1. Select **My Data**.
2. Select **Import/Export**.
3. Select **Erase From System**.
4. Select **Erase Waypoints From System**.
A list of all waypoint groups is displayed.

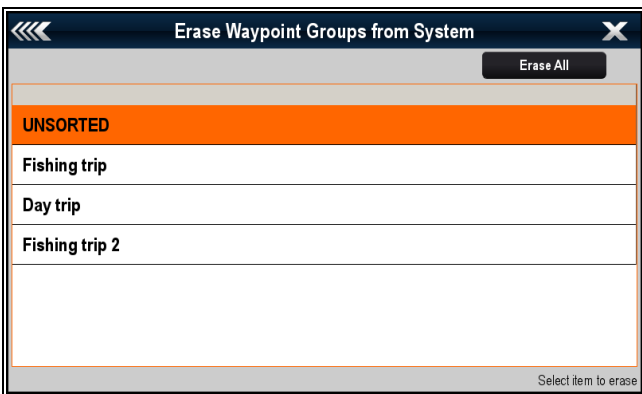

5. Select **Erase All**.
The confirm delete pop up message is displayed.
6. Select **Yes** to confirm, or **No** to cancel.

Waypoint search

The waypoint search feature allows you to search for waypoints on your system.

The search feature is available by selecting **Search** from the Waypoints list.

Waypoints can be searched for by:

- Name or keyword
- Symbol
- Area

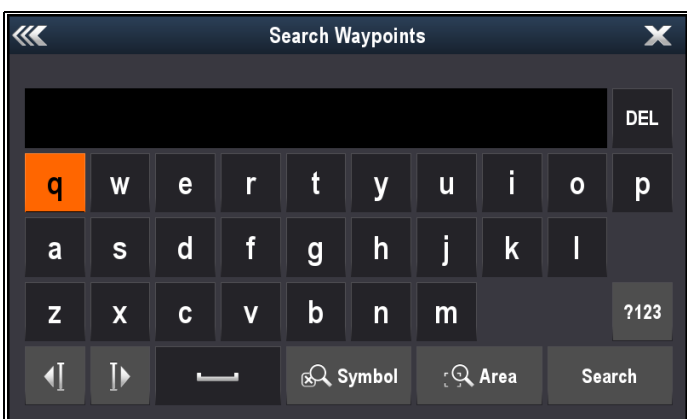

From the search results you can erase all the waypoints in the search list, move them to an existing or new waypoint group or assign all of the waypoints the same waypoint symbol.

Searching for waypoints by name or keyword

Waypoints can be searched for by name or keyword.

From the Waypoints list:

1. Select **Search**.
The search page is displayed.
2. Use the on-screen keyboard to enter the waypoint name or keyword.
3. Select **Search**.
The search results are displayed.

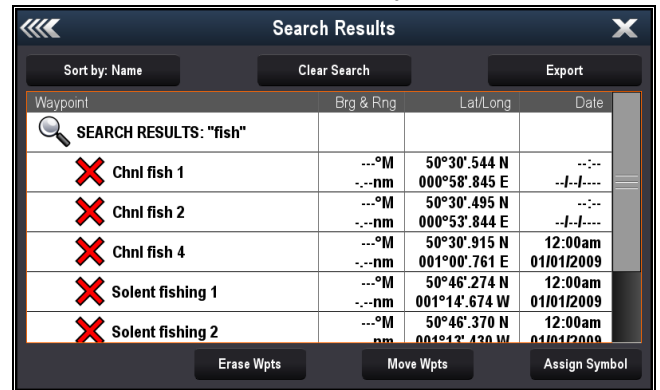

4. Select **Erase Wpts** to erase the list of waypoints from your system, or
5. Select **Move Wpts** to move the waypoints to a new or existing group, or
6. Select **Assign Symbol** to assign a new symbol to all the waypoints in the search results list.

You can also select a waypoint from the list to view its details, or if accessed from the Chart application set a goto or display the waypoint in the Chart application.

Searching for waypoints by symbol

Waypoints can be searched for by waypoint symbol.

From the Waypoints list:

1. Select **Search**.
The search page is displayed.
2. Select **Symbol**.
The waypoints symbol list is displayed.
3. Select the symbol that is assigned to the waypoint(s) you want to search for.
A list of all waypoints using the selected symbol is displayed.

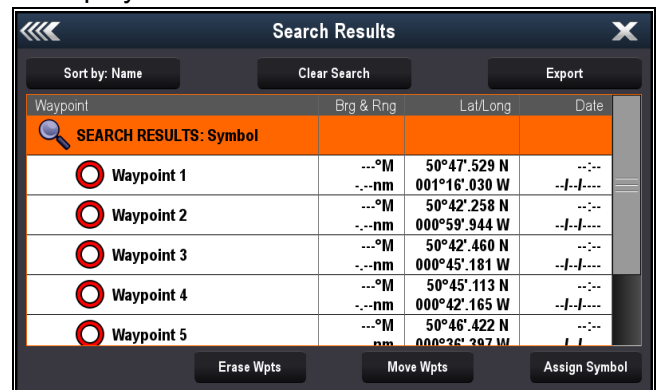

4. Select **Erase Wpts** to erase the list of waypoints from your system, or

5. Select **Move Wpts** to move the waypoints to a new or existing group, or
6. Select **Assign Symbol** to assign a new symbol to all the waypoints in the search results list.

You can also select a waypoint from the list to view its details, or if accessed from the Chart application set a goto or display the waypoint in the Chart application.

Searching for waypoints by area

Waypoints can be searched for by selecting an area in the Chart application.

From the Chart application:

1. Select **Menu**.
2. Select **My Data**.
3. Select **Waypoints**.
The waypoints list is displayed.
4. Select **Search**.
The search page is displayed.
5. Select **Area**.
The Chart application is displayed with the area search menu open.
6. Select the location for the first corner point of the search area.
7. Select the location for the opposite corner of the search area.

A box is drawn on the screen which covers the selected area.

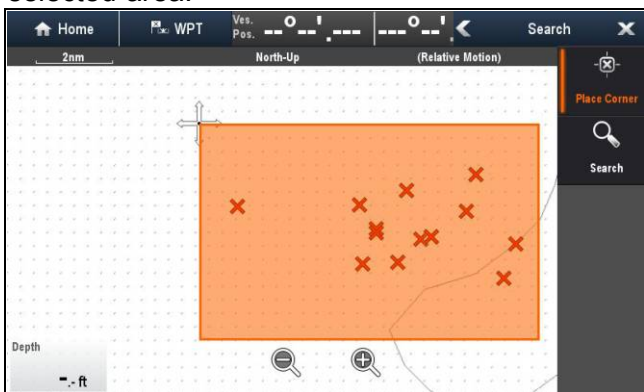

If the box is drawn in the wrong place you can draw a new area by selecting 2 new corner points.

8. Select **Search** from the menu.
A list of all waypoints in the selected area is displayed.

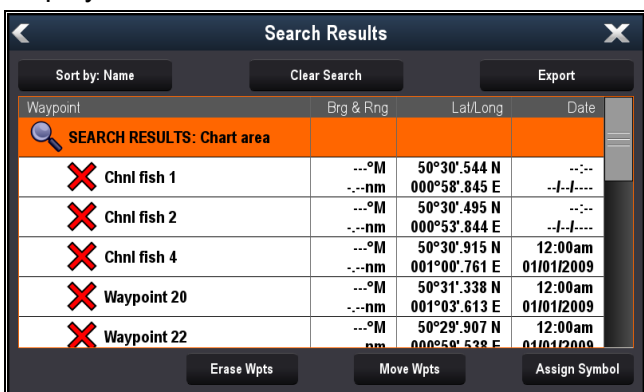

9. Select **Erase Wpts** to erase the list of waypoints from your system, or
10. Select **Move Wpts** to move the waypoints to a new or existing group, or

11. Select **Assign Symbol** to assign a new symbol to all the waypoints in the search results list.

























You can also select a waypoint from the list to view its details, set a goto or display the waypoint in the Chart application.

Waypoint symbols

A Range of waypoint symbols are available that can be used to represent different waypoint types.

	Black Cross		Red Cross
	Black Circle		Red Circle
	Black Square		Red Square
	Black Triangle		Red Triangle
	Blue Cross		Green Cross
	Blue Circle		Green Circle
	Blue Square		Green Square
	Blue Triangle		Green Triangle
	Anchor		Wreck
	Buoy		Fuel
	Toilets		Restaurant
	Ramp		Caution
	Green racemark anti-clockwise		Green Racemark clockwise
	Yellow racemark anti-clockwise		Yellow Racemark clockwise

	Red racemark anti-clockwise		Red Racemark clockwise
	Marker		Restriction
	Bottom Mark		Top Mark
	Route Start		Route End
	Diver Down		Diver Down 2
	Oil Rig		Filled Circle
	FAD (Fish Attracting Device)		Concrete Rubble
	Seaweed		Oyster
	Green Can		Green Nun
	Red Can		Red Nun
	Yellow Can		Yellow Nun
	Fish Trap		Brushpile
	Preferred Marks		Post
	Ledge		Fish
	Fish 1 Star		Fish 2 Star
	Fish 3 Star		School Fish
	Lobster		Small Fish

	Rocks		Reef
	Private Reef		Public Reef
	Dolphin		Shark
	Billfish		Tank
	Reef Ball		Sailboat
	Sportsfisher		Trawler
	Swimmer		Martini
	Tree		Tower
	Hill or Peak		Bridge
	Airplane		Car
	Skull		Diamond T
	Diamond Quarter		Filled Triangle

Showing and hiding waypoint groups

From the chart or radar application:

1. Select **WPT**.
2. Select **Display Wpts on: Chart**, or **Display Wpts on: Radar** depending on the application you have open.

The Show/Hide waypoints list is displayed.



In the example above the Day Trip group will not be displayed in the Chart application.

3. Select **Sort by:** to switch between Groups and Symbols.

A list of Symbols or Groups is displayed.

4. Select the Group or Symbol from the list that you want to show or hide.

If **Show** is displayed in the list then the group or symbols will be displayed, if **Hide** is displayed in the list then the group or symbols are not displayed in the application.

5. Repeat Step 4 for each waypoint group or symbol type you want to show or hide.
6. Alternatively to show or hide all waypoints select **Show All** or **Hide All** to show or hide all waypoints.

The list of waypoints and symbols can also be accessed from the application menu:

- Chart application: **Menu > My Data > Waypoints.**
- Radar application: **Menu > Presentation > Select WPTs To Display.**

17.2 Routes

A route is a series of waypoints typically used to assist with passage planning and navigation.

A route is displayed on screen as a series of waypoints linked by a line.

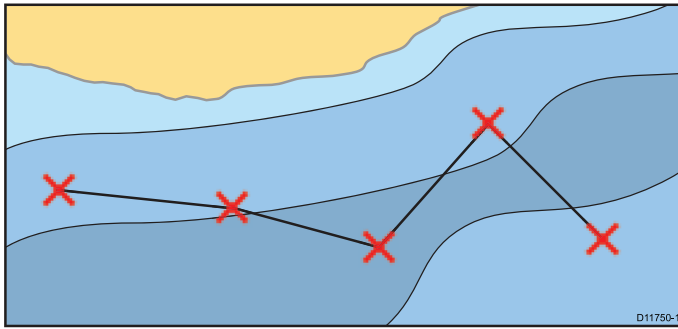

Route features

There are a range of route features for building, navigating and managing routes.

The route features allow you to:

- Build and save a route for use when required (stored in the route list).
- Navigate (follow) routes.
- Manage and edit routes stored on the system.
- Build a route from an existing track.

Route features are accessed from the chart application:

- by selecting an existing route.
- by using the **Build Route** option from the chart context menu.
- by using the Chart application menu: **Menu > Navigate > Follow Route** or **Build Route**.

Note: The Route List can also be accessed from the homescreen by selecting **My Data** and then **Routes**.

Route building

A route can consist of a combination of:

- New waypoints
- existing waypoints
- an existing track

As each waypoint is added, it is assigned an index number corresponding to its position in the route and drawn on the chart using the currently specified symbol. The following should be noted:

- When a route is being built it is not active and does not affect any current navigation.
- You cannot save a new route if any of the waypoints within it are currently active.



Building a route

You can build a route on a touchscreen multifunction display by following the steps below.

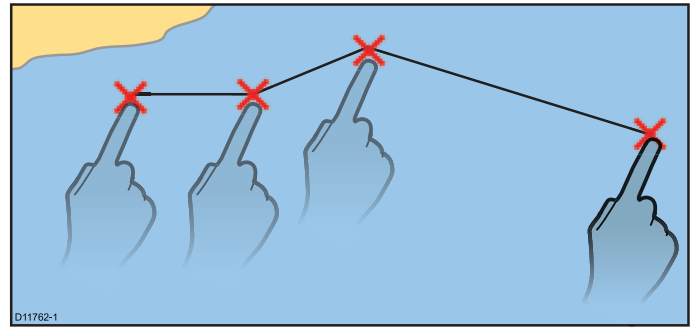

From the chart application:

1. Select and hold a location on screen.
The chart context menu is displayed.
2. Select **Build Route**.
The build route menu is displayed.
3. Select a location on screen to be the starting position.
4. Select relevant locations to place subsequent waypoints in order.
The route is saved and displayed as each waypoint is placed.
5. When complete select **Finish Build**.
The finish route build pop up message is displayed.
6. Select **Follow** to immediately follow the route. or
7. Select **Edit** to change the route name or change the route color. or
8. Select **Exit** to save the route and return to the chart application.

Note: If you place a waypoint at the wrong position, select **Undo Waypoint** from the Route Menu.



Building a route

From the chart application:

1. Select **Menu**.
2. Select **Navigate**.
3. Select **Build Route**.
The build route menu is displayed.
4. Select **Place Wpt**.
5. Using the **Joystick** select a location on screen.
6. Press the **Ok** button to place the first waypoint in the route.
7. Use the **Joystick** and the **Ok** button to place subsequent waypoints.
The route is saved and displayed as each waypoint is placed.
8. When your route is complete select **Finish Build**.
The finish route build pop up message is displayed.
9. Select **Follow** to immediately follow the route. or
10. Select **Edit** to change the route name or change the route color. or

11. Select **Exit** to save the route and return to the chart application.

Note: If a track break occurs, only the last segment is converted to a route.

Note: If you place a waypoint at the wrong position, select **Undo Waypoint**.

Building a route from a track

From the Track List:

- accessed from the homescreen: **My Data > Tracks**
 - accessed from the chart application: **Menu > My Data > Tracks**
1. Select the Track you want to convert to a route. The track options dialog is displayed.
 2. Select **Create Route From Track**. On completion, the maximum deviation of the route from the recorded track is displayed in a dialog and the new route is added to the route list. It can now be displayed, edited and erased etc. in the same way as other routes in the system.
 3. Select **Ok** to confirm.
 4. Select **Edit** to change the name and line color of the created route.

Building a route from a track displayed on the chart

From the chart application:

1. Select the required track. The track context menu is displayed.
2. Select **Create Route From Track**. On completion, the maximum deviation of the route from the recorded track is displayed in a pop up message and the new route is added to the route list. It can now be displayed, edited and erased etc. in the same way as other routes in the system.
3. Select **Ok** to confirm.
4. Select **Edit** to change the name and line color of the created route.

Building a route using the waypoint list

From the chart application:

1. Select **Menu**.
2. Select **Navigate**.
3. Select **Build Route**. The build route menu is displayed.
4. Select **Use WPT List**. The waypoint list is displayed.
5. Select the required waypoint. You will be taken back to the build route menu.
6. Add subsequent waypoints to the route. The route is saved and displayed as each waypoint is placed.
7. When your route is complete select **Finish Build**. The finish route build pop up message is displayed.
8. Select **Follow** to immediately follow the route. or
9. Select **Edit** to change the route name or change the route color. or
10. Select **Exit** to save the route and return to the chart application.

Note: If you select the wrong waypoint, select **Undo Waypoint** from the route menu.



Adjusting chart range while building a route

From the Build Route menu:

1. Use the on-screen **Range In** and **Range Out** icons to range in and out of the chart.



Adjusting the chart range while building a route

From the Build Route menu:

1. Use the **Range In** and **Range Out** buttons to range in and out of the chart.

Build a route from a track

You can create a route from a recorded track.

When a track is converted the system creates the closest route through the recorded track, using the minimum number of waypoints. Each waypoint created will be saved with the depth and temperature data (if applicable) for that position.

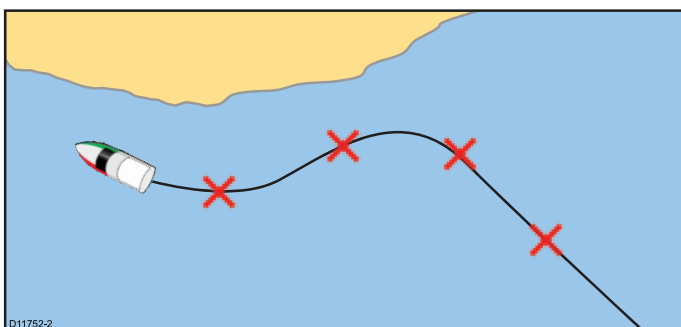

Autorouting

While building a route, the **Autorouting** feature can be used to create the shortest route between 2 waypoints.

Autorouting requires **Navionics® Updates**, **Navionics® Platinum™** or **Navionics® Platinum™+** cartography. **Autorouting** can be used when creating new routes or when adding a route leg to an existing route.



Autorouting generates a route based on the bottom depth data available on compatible cartography and the user defined **Minimum Safe Depth** setting. Waypoints automatically generated using **Autorouting** will be restricted from entering water that is too shallow for the vessel.

Important: When using **Autorouting** the following restrictions apply:

- **Autorouting** can only be used when generating routes within the area covered by your compatible cartography.
- **Autorouting** can be used between waypoints less than 100 nm apart.
- **Autorouting** always uses the cartography's minimum depth reading when calculating routes.
- **Autorouting** will fail if the generated route will exceed the maximum waypoint or route capacity of the MFD.
- **Autorouting** will also fail if insufficient cartographic data is available.



Warning: Autorouting

Routes created using the **Autorouting** feature rely on Bottom Depth information taken from compatible electronic cartography and a user defined **Minimum Safe Depth** value. As both of these values are subjective the generated route **MUST** be carefully checked and if necessary edited **BEFORE** starting to follow the route in the Chart application.



Warning: Autorouting — Traffic separation

The **Autorouting** feature does not adhere to the Traffic Separation Schemes identified in Rule 10 of the *International Regulations for Preventing Collisions at Sea 1972* as amended.

Raymarine® therefore recommends that you do **NOT** use **Autorouting** to create any part of a route which will cross traffic lanes or pass near to traffic separation lines. In these situations **Autorouting** **MUST** be switched Off and the route or route leg **MUST** be built manually, ensuring compliance to the rules laid out in the above regulations.

Building a route using Autorouting

Autorouting can be used to create an entire route or can be activated at any time when building a new route.

From the Chart application:

1. Select **Build Route** from the chart context menu or the **Navigate** menu.
The Build Route menu is displayed.
2. Select **Autorouting** so that On is selected.

Autorouting can be switched On and Off at any time during route building.

3. Select the position on the Chart where you want the route or route leg to start.



4. Select the position on the Chart where you want the route or route leg to end.



The system will try to automatically calculate the shortest safe route between the 2 points.

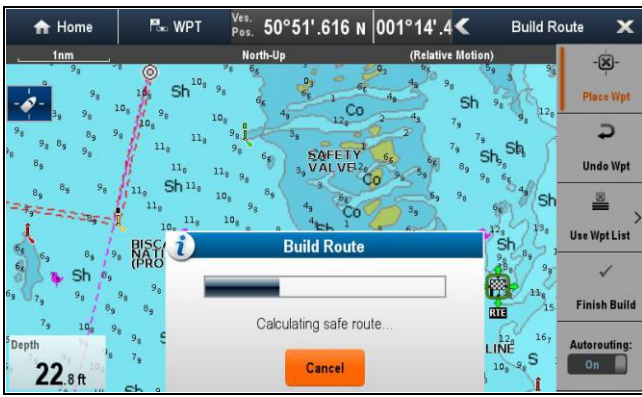

If the **Autorouting** completes successfully the calculated route is displayed.



Waypoints within the route that were calculated using **Autorouting** are assigned the Marker waypoint symbol.

- Subsequent route legs can be added by selecting the next desired location on the Chart.
- When your route is complete select **Finish Build**. The Finish Route Build warning is displayed.

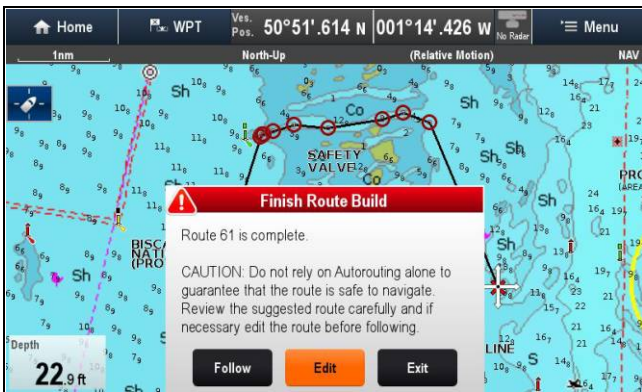

- Select **Exit** to complete the route and close the **Build Route** menu.
- Select **Follow** to immediately start following the generated route.

Important: Do not rely on **Autorouting** alone to guarantee that the route is safe to navigate. Review the suggested route carefully and if necessary edit the route before following.

9. Select **Edit** to display the Route in the Route List

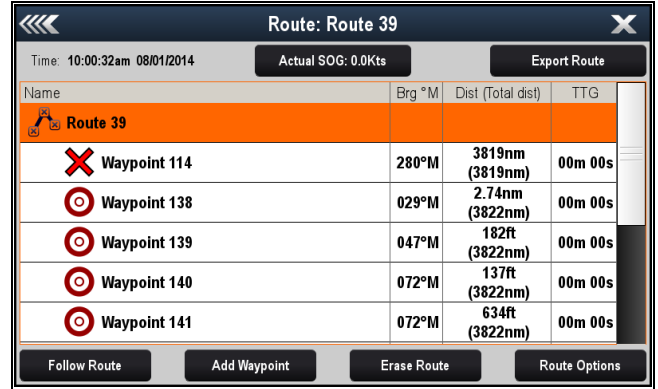

You can further customize the route from the route list. Reviewing the route list is not an adequate method of checking a route, please refer to [Reviewing a route generated using Autorouting](#) for details on how to check a route.

Once finished routes generated using **Autorouting** will behave the same as any other route.

Important: **Autorouting** will NOT be used when moving waypoints within routes, extra care should be taken to ensure that the route leg and any moved waypoints are safe to navigate.

Reviewing a route generated using Autorouting

Before you start to follow any route you should review each waypoint and route leg to ensure it is appropriate to follow.

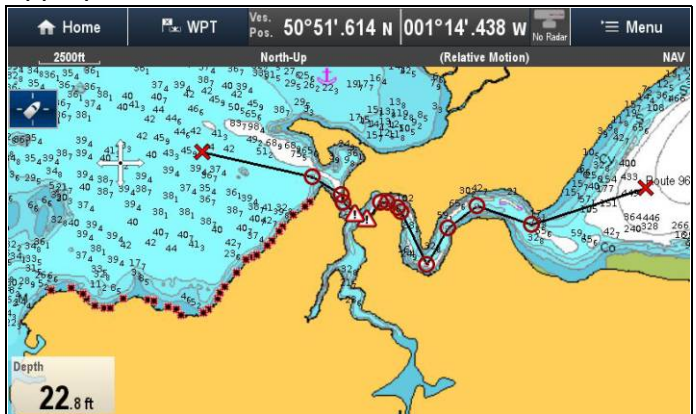

With the completed route displayed on-screen:

- Range in** on the route to identify areas of caution.



Areas of caution will be identified by the use of the **Caution** waypoint symbol before and after the cautionary area.

- Range in** further to review the area around and between the caution symbols.

In the example below the route passes close to a charted buoy.

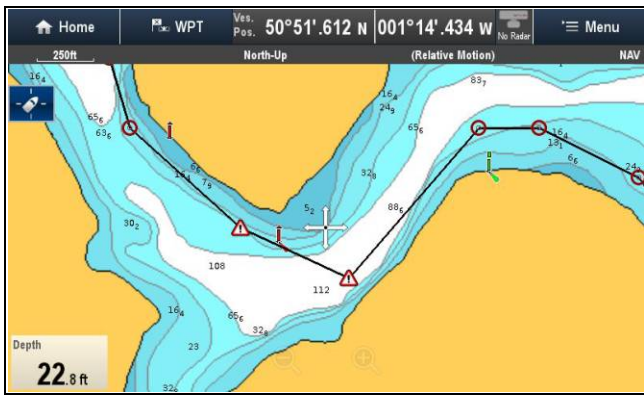

- Once the reason for the caution has been identified you can manipulate the route by moving the caution waypoints so that the caution area is avoided.



Important: Autorouting will NOT be used when moving waypoints within routes, extra care should be taken to ensure that the route leg and any moved waypoints are safe to navigate.

- Scroll over the entire route to identify any other areas that might be of concern, that were not highlighted during **Autorouting**.

Troubleshooting Autorouting

The information below details the warnings that can be displayed when using **Autorouting**, a description of what the warning means and actions to be taken to correct the issue.

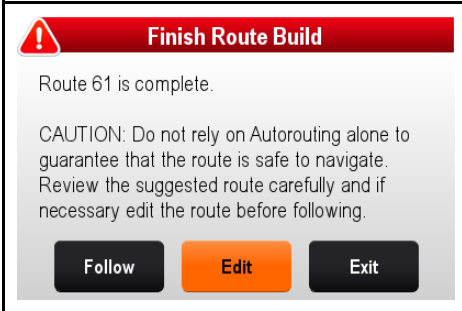
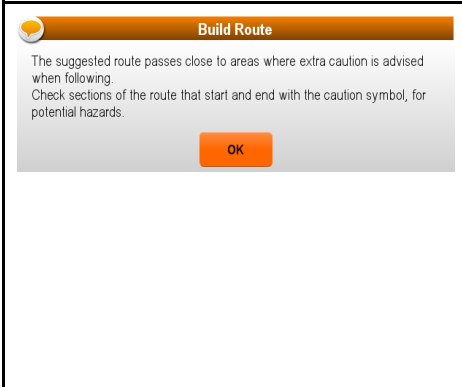
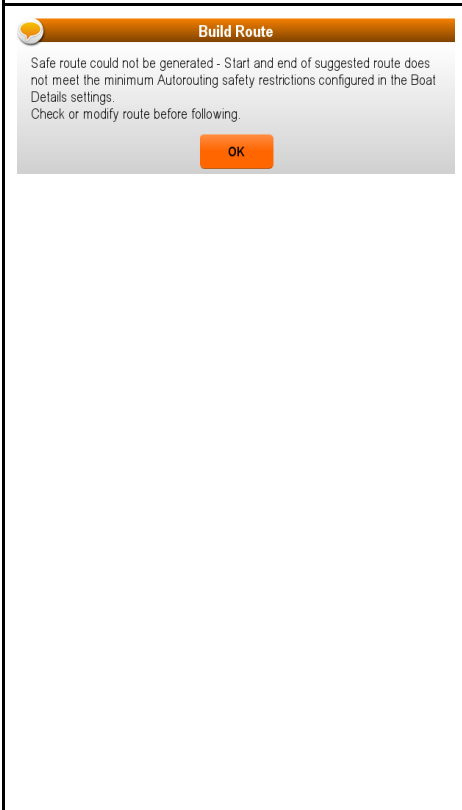
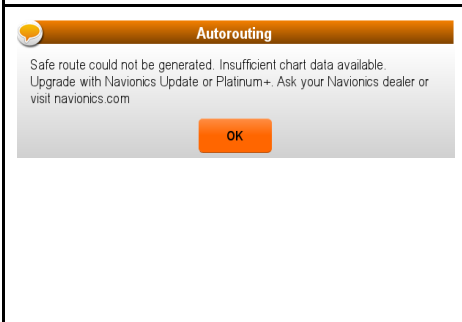
Warning message	Description	Resolution
 <p>Finish Route Build</p> <p>Route 61 is complete.</p> <p>CAUTION: Do not rely on Autorouting alone to guarantee that the route is safe to navigate. Review the suggested route carefully and if necessary edit the route before following.</p> <p>Follow Edit Exit</p>	<p>Autorouting has completed successfully</p>	<p>The Route maybe followed AFTER it has been reviewed to ensure that the generated route is safe for your vessel to follow.</p>
 <p>Build Route</p> <p>The suggested route passes close to areas where extra caution is advised when following. Check sections of the route that start and end with the caution symbol, for potential hazards.</p> <p>OK</p>	<p>Autorouting has completed successfully, however the route passes close to areas where extra caution is advised (e.g. a charted buoy). The caution areas will be between waypoints that have been assigned caution symbol.</p>	<p>The route must be reviewed as follows:</p> <ul style="list-style-type: none"> Identify any waypoints using the caution symbol (these will be in sets of 2), check between the caution symbols to identify the reason for the caution. If possible move the waypoint(s) to avoid the hazard. Review all route legs and their waypoints to ensure appropriate before following the route.
 <p>Build Route</p> <p>Safe route could not be generated - Start and end of suggested route does not meet the minimum Autorouting safety restrictions configured in the Boat Details settings. Check or modify route before following.</p> <p>OK</p>	<p>The start and or end point of the route does not meet the minimum safe values specified in the Boat Details settings. The start and end waypoints will be created and joined with a straight route leg, however there will be no automatically generated waypoints and the waypoint symbols will be changed to caution symbols.</p>	<p>Perform the following checks:</p> <ul style="list-style-type: none"> Check that the values specified in the Boat Details settings are correct. Using the context menu check the Chart Objects menu at the exact location of the start and or end points to establish if the Depth range min value meets you Minimum Safe Depth. <div style="border: 1px solid black; padding: 5px;"> <p>Note:</p> <ul style="list-style-type: none"> If no minimum value for depth is available at the desired location Autorouting will assume a minimum depth of 0 feet. Autorouting adds its own safety margin of 0.8 m or 20% of the specified Minimum Safe Depth which ever is greater. </div> <ul style="list-style-type: none"> Check for any other hazards that would prevent Autorouting from generating a route.
 <p>Autorouting</p> <p>Safe route could not be generated. Insufficient chart data available. Upgrade with Navionics Update or Platinum+. Ask your Navionics dealer or visit navionics.com</p> <p>OK</p>	<p>There is insufficient data available on the cartography to generate the route, The start and end waypoints will be created, however there will be no automatically generated waypoints and the waypoint symbols will be changed to caution symbols.</p>	<ul style="list-style-type: none"> Insert compatible cartography (Navionics® Updates or Navionics® Platinum™+) Update existing cartography <div style="border: 1px solid black; padding: 5px;"> <p>Note: There may be certain areas where sufficient details are not yet available even on the latest cartography.</p> </div>

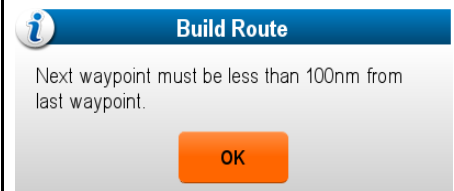
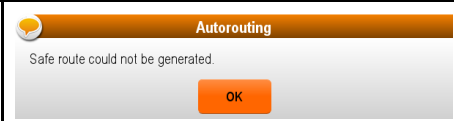
Warning message	Description	Resolution
 <p>Build Route</p> <p>Next waypoint must be less than 100nm from last waypoint.</p> <p>OK</p>	The start and end point of the desired route are further than 100 nm apart.	Create smaller route legs. e.g. instead of trying to create a route from point A to point B, create a route from point A to point B to point C to point D, this will enable a route longer than 100 nm to be created using Autorouting for each route leg.
 <p>Autorouting</p> <p>Safe route could not be generated.</p> <p>OK</p>	A safe route could not be generated The first waypoint will be placed but the end waypoint will not.	Check the chart area along the expected route to identify areas which cannot be navigated through due to obstacles or land mass.

Review or edit a route

There are a variety of attributes associated with routes. These can be reviewed and edited.

You can:

- Show or hide a route on the chart screen.
- Review details of the route
- Change the name or color of a route.
- Add, move and remove waypoints from a route.
- Change the route lines width.

Note: An active route can be edited, with the exception of the active waypoint. If a waypoint being edited becomes active, then the system shall cancel the edit; the waypoint shall remain in its original position.

Showing or hiding routes and tracks

From the chart application:

1. Select **Menu**.
2. Select **My Data**.
3. Select **Routes** or **Tracks**.
4. Select **Show/Hide**.
5. Select the route or track to switch between Show and Hide.

Selecting a route to review or edit

1. Do one of the following to select the required route:
 - From the chart application, select a route on screen to display the route context menu.
 - From the chart application, select: **Menu > My Data > Routes** and select the required route from the list.
 - From the Homescreen, select: **My Data > Routes** and select the required route from the list.

Adding a waypoint to a route on the chart screen

From the chart application:

1. Select the appropriate leg of the route.
The route context menu is displayed.
2. Select **Insert Waypoint**.
3. Select the location for the new waypoint.
The leg of the route is stretched to include the new waypoint.

Removing a waypoint from a route

From the chart application:

1. Select the waypoint you want to erase.
The waypoint context menu is displayed.
2. Select **Remove Waypoint**.
The Remove waypoint dialog is displayed.
3. Select **Yes** to confirm or **No** to cancel the action.

The waypoint will be removed from the route but will still be available.

Moving a waypoint within a route

From the chart application:

1. Position the cursor over the waypoint you want to move.
The waypoint context menu is displayed.
2. Select **Move Waypoint**.
3. Select the new location for the waypoint.

Erasing routes

Erasing a displayed route

From the chart application:

1. Select the route.
The Route context menu is displayed.
2. Select **Erase Route**.
The erase route pop up message is displayed.
3. Select **Yes** to confirm, or **No** to cancel the action.

Erasing a route using the route list

From the Chart application menu or the Homescreen:

1. Select **My Data**.
2. Select **Routes**.
The route list is displayed.
3. Select the route you want to erase.
4. Select **Erase route**.
The erase route dialog is displayed.
5. Select **Yes** to confirm, or **No** to cancel the action.

Note: You can delete any route, except for the one that you are currently following. When you erase a route, only those waypoints associated with that route are deleted.

Erasing all routes

From the homescreen:

1. Select **My Data**.
2. Select **Import/Export**.
3. Select **Erase from System**.
4. Select **Erase Routes from System**.
The erase routes from system dialog is displayed.
5. Select **Erase All**.
The confirm delete dialog is displayed.
6. Select **Yes** to confirm, or **No** to cancel the action.

Route context menu

Placing the cursor over a route in the chart application displays a context menu showing the leg of the route highlighted by the cursor and menu items.

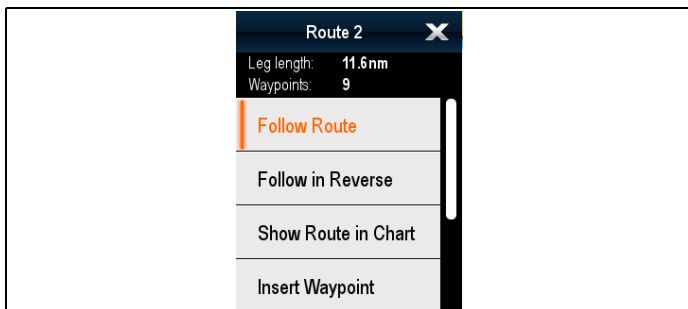

The context menu provides the following menu items:

- **Follow Route**
- **Follow Route In Reverse**
- **Hide Route**
- **Insert Waypoint**
- **Edit Route**
- **Erase Route**
- **Add Route Leg**
- **Acquire Target** (only available if Radar overlay is switched on.)

When following a route the context menu options change to:

- **Stop Follow**
- **Restart XTE**
- **Advance Waypoint**
- **Insert Waypoint**
- **Edit Route**
- **Erase Route** — Disabled
- **Add Route Leg**
- **Acquire Target** (only available if Radar overlay is switched on.)

Accessing the context menu

You can access the context menu by following the steps below.

1. Non-touchscreen and HybridTouch displays:
 - i. Selecting a location, object or target on-screen and pressing the **Ok** button.
2. HybridTouch and Touch only displays:
 - i. Selecting an object or target on-screen.
 - ii. Selecting and holding on a location on-screen.

17.3 Tracks

A track is an on-screen trail that shows the passage you have taken. This trail is made up of a series of track points which are created automatically. You can save the track to create a permanent record of where you have been

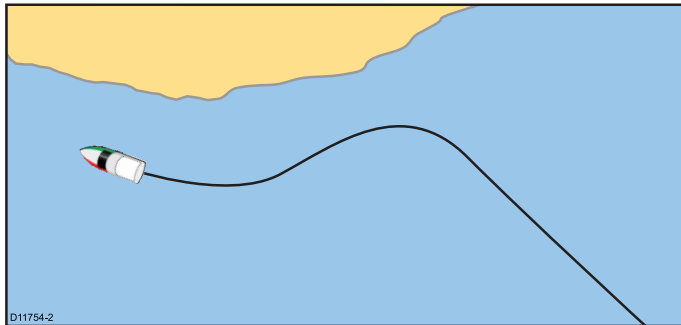

With tracks you can:

- Review where you have been.
- Create a route from a track.

Creating a track

From the chart application menu:

1. Select **Navigate**.
2. Select **Start Track**.
The start track pop up message is displayed.
3. Select **Ok**.

As you navigate your vessel, your journey is automatically recorded as a track.

Note: If the power fails whilst a track is being recorded or the position fix is lost, a break will occur in the track.

Note: If the maximum number of tracking points is reached, you will be warned. The track will continue to be recorded with the earlier tracking points being overwritten.

4. To complete your track select **Stop Track** from the **Navigate** menu: **Menu > Navigate > Stop Track**.
The track stopped pop up message is displayed.
5. Select **Save**, **Erase** or **Cancel**.
 - **Save** — Will save the track and open the Edit track Properties dialog where you can name the track and choose a color for the track line.
 - **Erase** — Will erase the track.
 - **Cancel** — Will cancel the Stop Track action.

Track interval

The track interval specifies the time period or distance between the points in a track.

You can adjust the interval between track points and choose the interval type (i.e. distance or time), which can help ensure best use of the available storage.

The settings are available from the Tracks Set-up options.

- **Record Track By** — specifies the interval type (Auto / Time / Distance).

- **Track Interval** — specifies the interval value (e.g. 15 minutes).

For example when creating a track for a long journey, an interval set to Auto could result in rapid use of all of the storage available for track points. In this case selecting a higher value for the Track Interval would provide capacity for a longer track.

Setting the track interval

From the My Data menu in the Chart application or on the Homescreen:

1. Select **Tracks**.
2. Select **Track Set-up**.
3. Select **Record Tracks By:** and set to the appropriate value:
 - **Auto**— The track interval is automatically set (Auto will minimize track points whilst maintaining correlation between the track and the actual path followed).
 - **Time**— The track points are placed at regular intervals of time.
 - **Distance**— The track points are placed at regular intervals of distance.
4. Select the **Track Interval** and set to the appropriate value:
 - Units of time (available if “record track by” is set to time).
 - Units of distance (available if “record track by” is set to distance).
 - Not available — no Track Interval is available if the “record track by” is set to auto).

Reviewing and editing a track

You can review and edit aspects of the tracks stored.

You can:

- Erase a track.
- Create a route from a track.
- Show or hide a track on the chart (only available from the chart application).
- Change the name of a track.
- Change the color of a track.

Showing or hiding routes and tracks

From the chart application:

1. Select **Menu**.
2. Select **My Data**.
3. Select **Routes** or **Tracks**.
4. Select **Show/Hide**.
5. Select the route or track to switch between Show and Hide.

Selecting a track to review or edit

1. Do one of the following to select the required track:
 - From the Chart application, select a track on screen to display the track context menu.

- From the Chart application, go to the following menu: **Menu > My Data > Tracks** , and select the required track.
- From the Homescreen, select: **My Data > Tracks** and select the required track.

You can then proceed and review or edit the required track using the options available.

Renaming a track

You can change the name of a saved track.

With the track list displayed.

1. Select the track you want to edit.
The track options page is displayed.
2. Select **Edit Name**.
The on-screen keyboard is displayed.
3. Use the on-screen keyboard to change the track name.
4. When finished Select **SAVE**.

You can also edit track details by selecting **Edit Track** from the track context menu.

Changing the color of a track

You can change the color of a saved track.

With the track list displayed.

1. Select the track you want to edit.
The track options page is displayed.
2. Select **Edit Colour**.
A list of colors is displayed.
3. Select the color you want to use.

You can also edit track details by selecting **Edit Track** from the track context menu.

Erasing tracks

Erasing a track

From the My Data menu:

1. Select **Tracks**.
The track list is displayed.
2. Select the track you want to erase.
3. Select **Erase Track**.
The erase track pop up message is displayed.
4. Select **Yes** to confirm, or **No** to cancel the action.

Erasing all tracks

From the Homescreen:

1. Select **My Data**.
2. Select **Import/Export**.
3. Select **Erase from System**.
4. Select **Erase Tracks from System**.
The tracks list is displayed.
5. Select **Erase All**.
The confirm delete dialog is displayed.
6. Select **Yes** to confirm, or **No** to cancel the action.

Track context menu

Selecting a track in the chart application displays a context menu showing the track length, number of points and menu items.

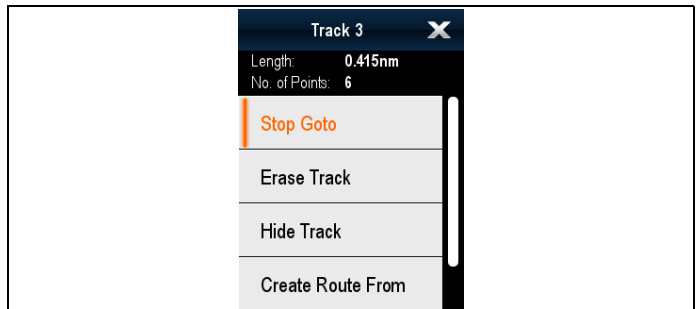

The context menu provides the following menu items:

- **Stop Goto** (only available during active navigation.)
- **Erase Track**
- **Hide Track**
- **Create Route From**
- **Rename**
- **Edit Color**
- **Acquire Target** (only available if Radar overlay is switched on.)

When creating a track the context menu options change to:

- **Stop Goto** (only available during active navigation.)
- **Stop Track**
- **Erase Route** — Disabled
- **Create Route From**
- **Rename**
- **Edit Color**
- **Acquire Target** (only available if Radar overlay is switched on.)

Accessing the context menu

You can access the context menu by following the steps below.

1. Non-touchscreen and HybridTouch displays:
 - i. Selecting a location, object or target on-screen and pressing the **Ok** button.
2. HybridTouch and Touch only displays:
 - i. Selecting an object or target on-screen.
 - ii. Selecting and holding on a location on-screen.

17.4 Import and Export

Waypoints, Routes and Tracks can be imported and exported using a memory card.

For details on importing and exporting waypoints, routes and tracks refer to: [8.4 Saving user data and user settings](#).

17.5 Waypoints, routes and tracks storage capacity

The display can store the following quantities of waypoints, routes and tracks

Way-points	<ul style="list-style-type: none">• 3000 waypoints• 100 waypoint groups, each group can contain up to 3000 waypoints
Routes	<ul style="list-style-type: none">• 150 routes, each route can contain up to 200 waypoints
Tracks	<ul style="list-style-type: none">• 15 tracks, each track can contain up to 10,000 points

Chapter 18: Chart application

Chapter contents

- 18.1 Chart application overview and features on page 220
- 18.2 Electronic charts overview on page 222
- 18.3 Navigation options on page 225
- 18.4 Chart ranging and panning on page 227
- 18.5 Chart selection on page 228
- 18.6 Vessel position on the chart display on page 228
- 18.7 Chart Orientation on page 229
- 18.8 Chart motion mode on page 230
- 18.9 Chart views on page 231
- 18.10 Chart display on page 233
- 18.11 Overlays on page 233
- 18.12 Chart vectors on page 240
- 18.13 Cartography objects on page 241
- 18.14 Object information on page 243
- 18.15 Depth & Contour options on page 247
- 18.16 My Data options on page 249
- 18.17 Multiple chart synchronization on page 249
- 18.18 Measuring distances and bearings on page 250

18.1 Chart application overview and features

The chart application provides route planning and navigation features. The Chart application is pre-loaded with a LightHouse Charts and Navionics world base maps. Compatible electronic charts can be used to expand the information and detail regarding your surroundings and charted objects. Depending on cartography type the chart application can be set to 2D or 3D view.

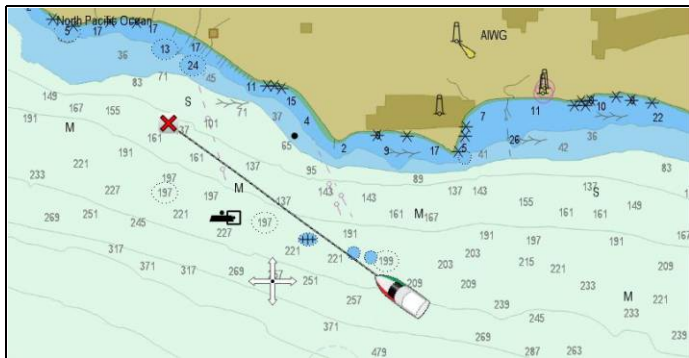

Typical Chart application includes the following features to help you navigate your vessel safely and effectively:

Features

Satellite-based navigation.	<ul style="list-style-type: none"> • GPS Status
Route planning with waypoints, routes and tracks.	<ul style="list-style-type: none"> • 17.1 Waypoints overview • 17.2 Routes • 17.3 Tracks • 8.4 Saving user data and user settings
Navigating using waypoints, routes and tracks.	<ul style="list-style-type: none"> • 18.3 Navigation options
Choice of electronic 2D and 3D cartography.	<ul style="list-style-type: none"> • 18.2 Electronic charts overview <ul style="list-style-type: none"> – LightHouse charts – Navionics charts • Electronic chart specification • Selecting 2D and 3D chart views
Enabling graphical overlays.	<ul style="list-style-type: none"> • 18.11 Overlays
Waypoints, routes and tracks backup and transfer	<ul style="list-style-type: none"> • 8.4 Saving user data and user settings
Display chart vectors	<ul style="list-style-type: none"> • 18.12 Chart vectors
Display animated current and tide information	<ul style="list-style-type: none"> • Animated current information • Animated tide information
Viewing information for charted objects and deciding which objects should be shown or hidden.	<ul style="list-style-type: none"> • 18.13 Cartography objects • 18.14 Object information

Control the level of detailed information displayed in the Chart application	<ul style="list-style-type: none"> • 18.10 Chart display • Chart detail
Measuring distances and bearings.	<ul style="list-style-type: none"> • 18.18 Measuring distances and bearings
Alter the Chart application's orientation to better suit your needs.	<ul style="list-style-type: none"> • 18.7 Chart Orientation
Change (offset) the vessel position in the Chart application.	<ul style="list-style-type: none"> • 18.8 Chart motion mode

Chart application synchronization

Wireless electronic chart (plotter) sync and waypoint sync with Navionics Mobile Marine app.	<ul style="list-style-type: none"> • Navionics mobile marine app • Navionics Freshest Data
Plan your journey at home, then transfer the routes to your MFD.	Refer to the Voyager Planner manual for more information (81339).

Chart datum

The chart datum setting affects the accuracy of the vessel position information displayed in the chart application.

In order for your GPS receiver and multifunction display to correlate accurately with your paper charts, they must be using the same datum.

The default datum for your multifunction display is WGS1984. If this is not the datum used by your paper charts, you can change the datum used by your multifunction display, using the system preferences page. The system preferences page can be accessed from the homescreen: **Set-up > System Settings > System Preferences > System Datum.**

When you change the datum for your multifunction display, the chart grid will subsequently move according to the new datum, and the latitude/longitude of the cartographic features will also change accordingly. Your multifunction display will attempt to set up any GPS receiver to the new datum, as follows:

- If your multifunction display has a built in GPS receiver it will automatically correlate each time you change the datum.
- If you have a Raymarine GPS receiver using SeaTalk or SeaTalk^{ng}, it will automatically correlate each time you change the datum on the multifunction display.
- If you have a Raymarine GPS receiver using NMEA0183, or a third-party GPS receiver, you must correlate it separately.

It may be possible to use your multifunction display to correlate an NMEA0183 GPS receiver. From the homescreen go to **Set-up > System settings > GPS Set-up > View Satellite Status**. If the datum version is displayed, it may be possible to change it. From the homescreen go to **Set-up > System settings > Data Sources > GPS Datum**.

Note: Raymarine recommends that you check the displayed vessel position in the chart application against your actual proximity to a known charted object. A typical GPS has an accuracy of between 5 and 15 m.

Chart context menu

The Chart context menu provides the cursors positional data and shortcuts to menu options.

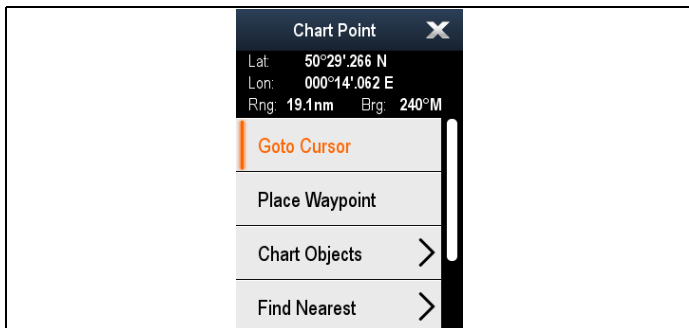

The method of selecting a chart object using a touchscreen display depends on the **Context Menu** setting in the chart **Set-up** menu, which can be set to Touch or Hold.

The context menu provides the following positional data for the cursor position in relation to your vessel:

- Latitude
- Longitude
- Range
- Bearing

The following menu items are available:

- **Goto Cursor / Stop Goto / Stop Follow**
- **Place Waypoint**
- **Photo**
- **Tide Station** (only available if a tide station is selected.)
- **Current Station** (only available if a current station is selected.)
- **Pilot Book** (only available at certain ports.)
- **Animate** (only available if a tide or current station is selected.)
- **Chart Objects**
- **Find Nearest**
- **Measure**
- **Build Route**
- **Acquire Target** (only available if Radar overlay is switched on.)
- **Slew thermal camera** (only available when thermal camera is connected and operating.)

Accessing the context menu

You can access the context menu by following the steps below.

1. Non-touchscreen and HybridTouch displays:
 - i. Selecting a location, object or target on-screen and pressing the **Ok** button.

2. HybridTouch and Touch only displays:
 - i. Selecting an object or target on-screen.
 - ii. Selecting and holding on a location on-screen.

Selecting context menu settings

On touchscreen multifunction displays you can choose how chart object context menus are accessed.

From the Homescreen:

1. Select **Customize**.
2. Select **Display Preferences**.
3. Select **Chart Ctxt Menu** to switch between Touch or Hold.
 - Hold — requires you to touch and hold on a chart object to access the context menu.
 - Touch — requires you to touch a chart object to access the context menu.

18.2 Electronic charts overview

Your multifunction display includes basic world base maps. Electronic charts provide additional cartographic information.

The level of cartographic detail shown varies for different chart types, geographic locations and chart scales. The chart scale in use is indicated by the on-screen scale indicator, the value displayed is the distance that the line represents across the screen.

You can remove and insert chart cards at any time. The chart screen is automatically redrawn when the system detects that a compatible chart card has been inserted or removed.

Using a dual view page it is possible to display different cartography types simultaneously.

Caution: Care of chart and memory cards

To avoid irreparable damage to and / or loss of data from chart and memory cards:

- DO NOT save data or files to a card containing cartography as the charts may be overwritten.
- Ensure that chart and memory cards are fitted the correct way around. DO NOT try to force a card into position.
- DO NOT use a metallic instrument such as a screwdriver or pliers to insert or remove a chart or memory card.



LightHouse charts

With the introduction of the LightHouse II software, Raymarine multifunction displays now support the use of Raymarine's new LightHouse charts.

LightHouse charts are derived from vector and raster based charts, the LightHouse chart engine enables Raymarine to offer new chart types and regions from around the globe.

Refer to the Raymarine website: for the latest information on available LightHouse charts.

Raster charts

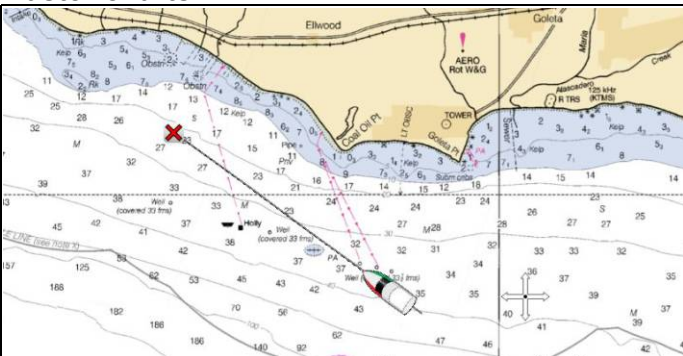

Raster charts are an exact copy / scan of an existing paper chart. All information is embedded directly in the chart. Ranging in and out of raster charts will make everything appear larger or smaller on the screen, including text. When changing the Chart application's orientation everything on the chart will rotate, including the text. As raster charts are a scanned image the file size is normally bigger when compared to the vector equivalent.

Vector charts

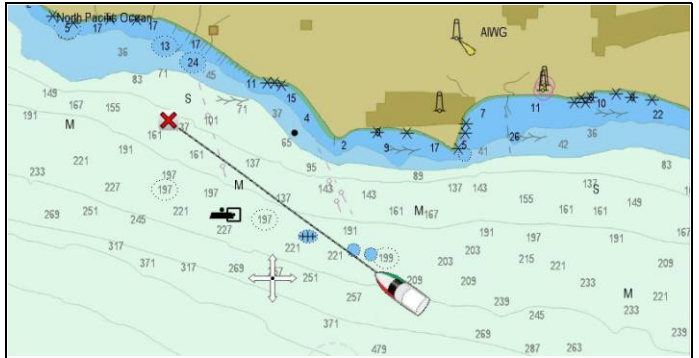

Vector charts are computer generated, consisting of a series of points and lines that make up the chart. Chart objects and overlays on vector charts can be switched on and off and chart objects can be selected to provide further information. Ranging in and out of vector charts will make geographical features appear larger or smaller on the screen, however text and chart objects will remain the same size regardless of range. When changing the Chart application's orientation geographical features will rotate but text and chart objects will remain in the correct orientation for the display. As vector charts are generated rather than a scanned image the file size is normally smaller when compared to the raster equivalent.

Downloading LightHouse™ charts

LightHouse™ charts can be downloaded through the Raymarine website.

Important: You must read and agree to the LightHouse™ charts End User License Agreement (EULA) before downloading and using LightHouse™ charts.

- Go to the LightHouse charts page of the Raymarine website: <http://www.raymarine.com/lighthousecharts/>.

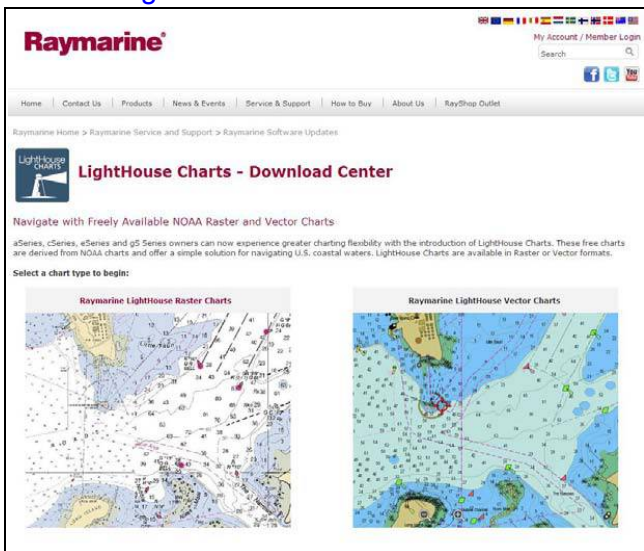

- Select either the Raster or Vector charts. The Chart regions page is displayed.

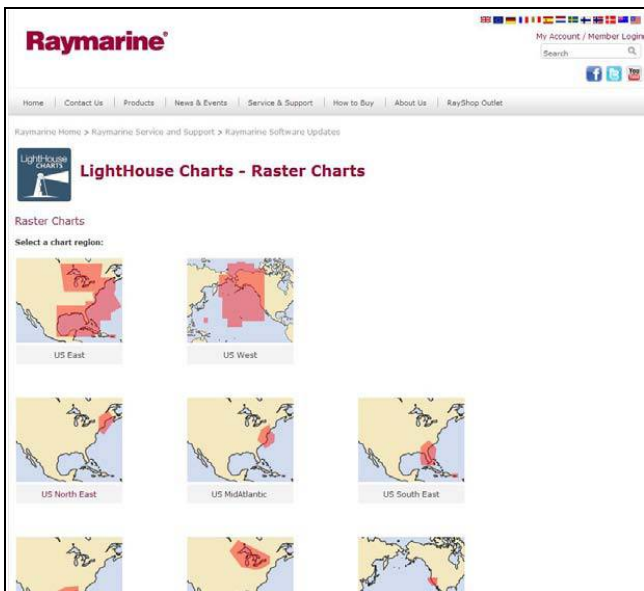

- Select your region. The chart region download page is displayed.

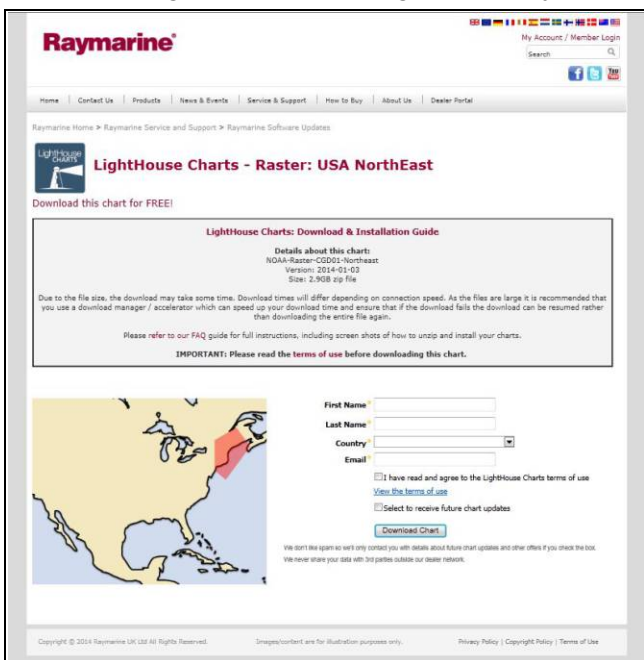

- Click 'View the terms of use'.

Chart application

- Read and ensure you FULLY understand the End User License Agreement (EULA).

You should only proceed to the next step if you agree to the terms of the EULA.

- Enter your details in the relevant fields.
- Click the check box against 'I have read and agree to the LightHouse Charts terms of use.'
- Click **Download Chart**.

The download should start automatically. A link is provided if the download does not commence.

Note:

- Due to the file size the download may take some time.
- Download times will differ depending on connection speed.
- As the files are large it is recommended that you use a download manager / accelerator which can speed up your download time and ensure that if the download fails the download can be resumed rather than downloading the entire file again.

- Wait for the download to finish.

The downloaded file can now be unzipped / extracted to memory card for use with your multifunction display.

Unzipping files to memory card

The LightHouse charts download file must be unzipped / extracted to memory card for use on your multifunction display.

- Note:** The instructions below are provided for guidance only. Depending on your PC's operating system and the archiving (zip) software in use the steps required may differ slightly from those shown below. If you are unsure please consult your operating system's and or archiving software's help files.

To unzip / extract charts with a filesize over 4GB you may need to install 3rd-party archiving (zip) software such as 7zip: <http://www.7-zip.org/>.

Ensure you have a memory card with sufficient space for the charts you want to download. The File size is displayed on each chart region's download page.

For best performance it is recommended that you use Class 10 or UHS (Ultra High Speed) class memory cards.

- Locate the downloaded file.

The file will be stored in the folder you selected or in your normal downloads folder.

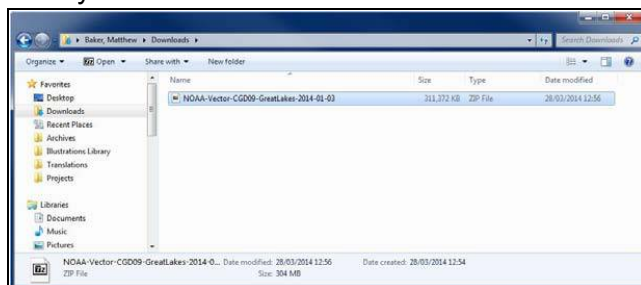

- Right click on the file and select the **Extract Here** option from the zip options.

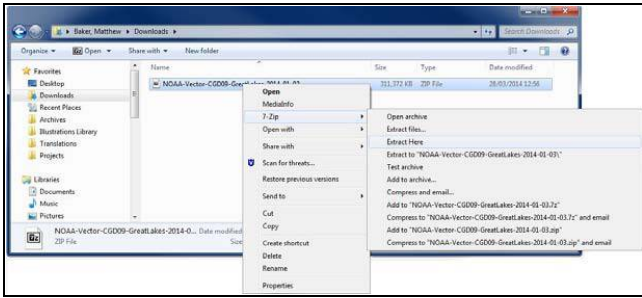

- Once all files have been extracted select the chart files.

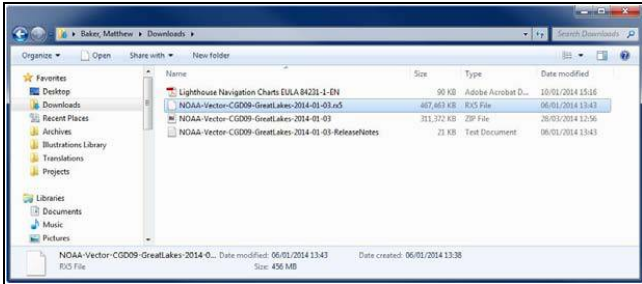

- Right click and choose **Send to > Removable Disk**

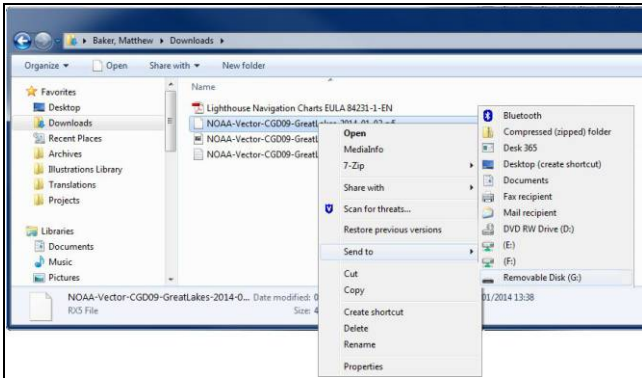

The Chart files will now be copied to your memory card.

- Check that the files have been successfully placed on your memory card by viewing its contents in your file browser.

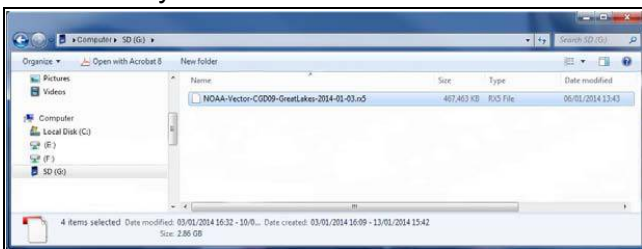

- Safely remove your memory card from your PC's card reader.
- Insert your memory card into the card reader of your multifunction display.
- Open the Chart application on your multifunction display.
- Select the new chart from the **Chart selection** menu: **Menu > Presentation > Chart Selection**.

The Chart screen will be redrawn to display the newly selected chart type.



Navionics charts

Your multifunction display is compatible with Navionics cartography.

The following Navionics cartography types are available for your multifunction display:

- Ready to Navigate
- Silver
- Gold
- Gold+
- Platinum
- Platinum+
- Fish'N Chip
- Hotmaps

To check the current availability of Navionics chart cards and types, please visit www.navionics.com or www.navionics.it.

Note: Refer to the Raymarine website (www.raymarine.com) for the latest list of supported cartography.

Navionics mobile marine app

You can wirelessly synchronize data between your multifunction display (MFD) and a mobile device that is running the Navionics mobile marine app.

The synchronization downloads Navionics Freshest Data from your mobile device to your MFD and uploads sonar logs from your MFD to your mobile device. Waypoints and routes can also be synchronized between your mobile device and MFD.

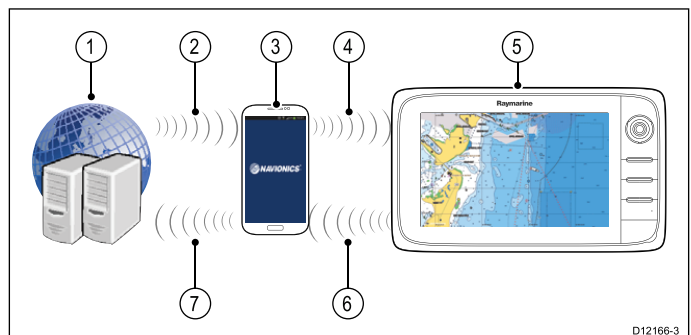

1	Navionics servers
2	Download Navionics Freshest Data to mobile device (internet connection required)
3	Mobile device running Navionics mobile app
4	Download Navionics Freshest Data to MFD (Wi-Fi connection to MFD required)
5	MFD

6	* Upload Sonar Logs and Community edits to mobile device (Wi-Fi connection to MFD required)
7	** Upload Sonar Logs and Community edits anonymously to Navionics servers (internet connection required)

Note:

* To participate in Navionics Sonar Charts, Sonar logging must be enabled on your MFD. Sonar Logs can be enabled from the Chart application menu: **Menu > Depth & Contour > Sonar Logs.**

** The Sonar logs shall be uploaded to Navionics servers anonymously.

To use this feature you must first:

1. Download and install the Navionics Mobile Marine app, available from the relevant app store.
2. Subscribe to Navionics Freshest Data.
3. Download Freshest data to your mobile device.
4. Enable Wi-Fi in the System Settings on the MFD.
5. Enable Wi-Fi on your mobile device.
6. Select the MFD Wi-Fi connection from the list of available Wi-Fi networks on your mobile device.

Navionics Freshest Data

Navionics offer a 12 month subscriptions to their Freshest Data service, which includes updates to nautical charts, sonar charts and community edits layer.

Nautical charts — Navionics 2D charts.

Sonar Charts — High definition bathymetry chart layer created by combining multiple data sources including Sonar Logs provided by Navionics community users.

Community Edits — Edits made by Navionics users.

To obtain Freshest Data insert your Navionics chart card into your PC, visit the Navionics website www.navionics.com and **Click** Downloads & Updates.

18.3 Navigation options

The chart application provides features to help navigate to a chosen location.

The navigation options are found in the Navigate menu: **Menu > Navigate**

- **Pilot Controls** — Accesses the Pilot Control Dialog, when Autopilot Control is enabled.
- **Goto Cursor** — Will set the cursor position as the active destination.
- **Goto Waypoint** — Provides options to navigate to a waypoint stored on the system
- **Stop Goto** — Stops the Goto Cursor or Goto Waypoint.
- **Stop Follow** — Stops following the current route.
- **Restart XTE** — Restarts the Cross Track Error.
- **Advance Waypoint** — When following a route, skips to the next waypoint in the route.
- **Follow Route** — Provides options to navigate to a route stored on the system
- **Start Track / Stop Track** — Will initiate a track on screen to plot your course as you progress or stop a track that is currently being created.
- **Build Route** — Provides options to build a route.

Refer to [Chapter 17 Waypoints, Routes and Tracks](#) for details on creating waypoints, routes and tracks.

Navigation

Navigating to a waypoint on the screen

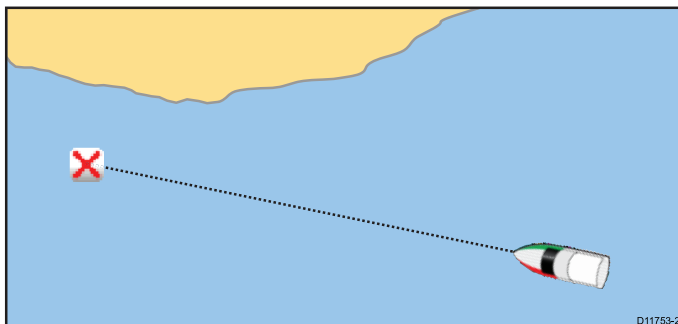

From the chart or radar application:

1. Select the waypoint.
The waypoint context menu is displayed.
2. Select the **Goto Waypoint**.

Note: With an active waypoint selected you can select **Stop Goto** option from the waypoint context menu at any time to cancel the action.

Navigating to a waypoint using the waypoints group list

From the Chart application:

1. Select **WPT**.
The waypoint menu is displayed.
2. Select **Waypoints**.
The waypoints group list is displayed.
3. Browse the group list for the relevant waypoint.
4. Select the waypoint.
The waypoint options dialog is displayed.
5. Select **Goto**.

Navigating to a location on the chart

From the chart application:

1. Select the required location on-screen.
The chart context menu is displayed.
2. Select **Goto Cursor**.

Navigating to the cursor position on the chart using the menu

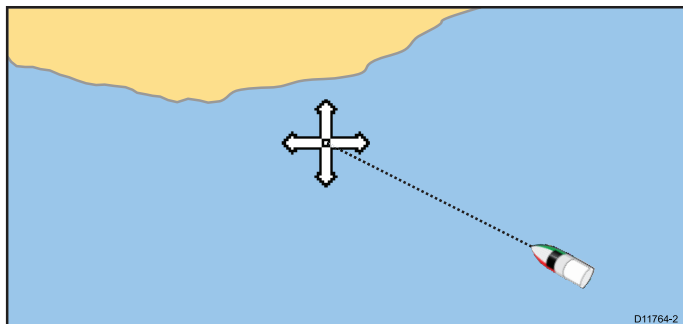

From the chart application:

1. Position the cursor at the desired destination on the chart.
2. Select **Menu**.
3. Select **Navigate**.
4. Select **Goto Cursor**.

Cancelling navigation to a waypoint

1. Select any position anywhere on-screen.
The waypoint context menu is displayed.
2. Select **Stop Goto**.
3. Alternatively, in the chart application, go to: **Menu > Navigate > Stop Goto**.

Note: Once navigation is no longer active, the waypoint symbol returns to its normal state, and the dashed line between your vessel and the waypoint is removed.

Arriving at a waypoint

As your vessel approaches a waypoint, the waypoint arrival alarm is triggered.

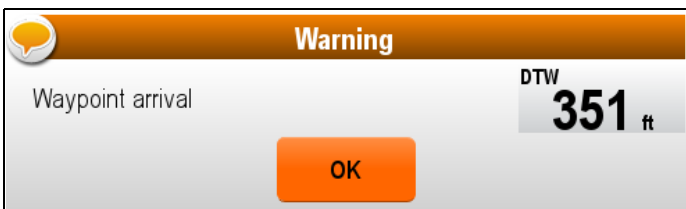

With the Waypoint arrival warning displayed:

1. Select **OK**.

Once the alarm is acknowledged:

- the Dialog is closed and the audible alarm is silenced.
- if navigating a route then the next waypoint is selected.

Note: You can set the radius (distance) of the waypoint arrival circle which is used to trigger the waypoint arrival alarm.

Cross Track Error (XTE)

Cross Track Error (XTE) is the amount of deviation from your intended route or waypoint, expressed as a distance.

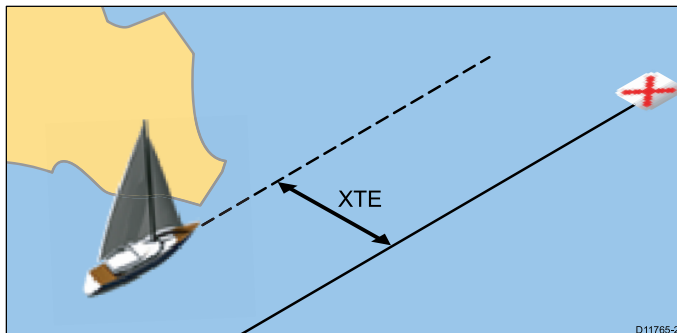

In the event that you steer off-track, you can go straight to your target by resetting XTE.

Resetting Cross Track Error (XTE)

While following a route in the chart application:

1. Select the route.
The route context menu is displayed.
2. Select **Restart XTE**.

Resetting XTE results in a new course from the current vessel position to the current target waypoint. This does not affect your saved route.

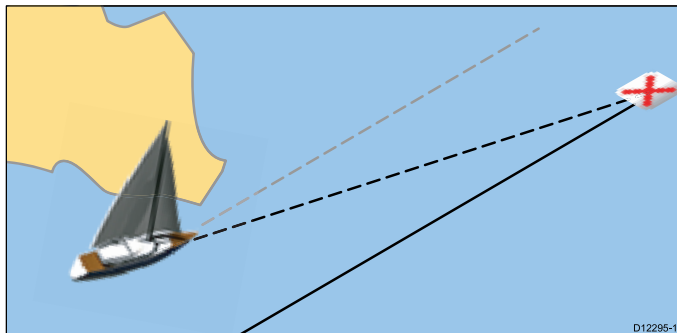

You can also reset the XTE from the Navigate Menu: **Menu > Navigate > Restart XTE**.

Navigating a route

You can follow any route stored on the display. When following a route you visit each waypoint in order. You may also use the follow route options in conjunction with a compatible autopilot to automatically navigate along your chosen route.

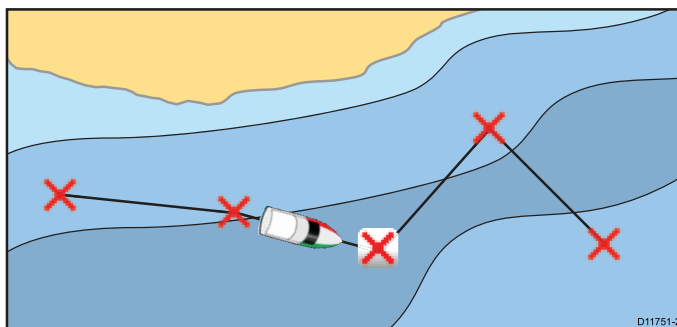

There are a number of ways to select the follow route option:

- Using a stored route within the route list.

- From a selected waypoint or any leg within a route.

You can also follow any route in reverse order.

Following a stored route

From the chart application:

1. Select **Menu**.
2. Select **Navigate**.
3. Select **Follow Route**.
The Route list is displayed.
4. Select the route you want to follow.
5. Select **Follow Route**, or
6. Select **Follow Route in Reverse** to follow the route in reverse order.

Cancelling navigation of a route

From the chart application:

1. Select the Route.
The route context menu is displayed.
2. Select **Stop Follow**.

Advancing to the next waypoint in a route

You can skip the current active waypoint and advance to the next waypoint in a route at any time.

While following a route in the chart application:



1. Select the route.
The route context menu is displayed.
2. Select **Advance Waypoint**.

Note: If the current destination is the last waypoint, the chart advances on to the first waypoint in the route.

18.4 Chart ranging and panning

Ranging in and out

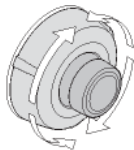
The table below shows the Range controls available for each display variant.

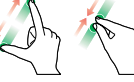
	Rotary Control	<ul style="list-style-type: none"> • c Series • e Series • RMK-9 keypad
	Range in and Range out buttons	<ul style="list-style-type: none"> • c Series • e Series (excluding e7 and e7D) • RMK-9 keypad
	Range in and Range out on-screen icons	<ul style="list-style-type: none"> • a Series • e Series • gS Series <div style="border: 1px solid black; padding: 5px; margin-top: 10px;"> <p>Note: e Series and gS Series on-screen range controls can be enabled and disabled from the Homescreen: Customize > Display Preferences > Range Controls</p> </div>
	Multi-Touch gesture — Pinch to Zoom	<ul style="list-style-type: none"> • a Series • gS Series



Panning the chart

You can pan the chart area on a touchscreen multifunction display by following the steps below.

In the chart application:

1. Swipe your finger across the screen from right to left to pan right.
2. Swipe your finger across the screen from left to right to pan left.
3. Swipe your finger across the screen from top to bottom to pan up.
4. Swipe your finger across the screen from bottom to top to pan down.



Panning the chart

You can pan the chart area on a non-touchscreen multifunction display by following the steps below.

From the chart application:

1. Move the **Joystick** in the direction you want to pan.

18.5 Chart selection

You can select the cartography type to be used in the Chart application. The Chart selection applies to the active Chart instance. You must have the necessary cartography chart cards inserted into your multifunction display in order to display different cartography type.



Selecting a cartography type

You can select the cartography type you want to display in the Chart application.

Ensure you have inserted the chart card that contains the cartography type you want to display.

From the Chart application menu:





1. Select **Presentation**.
2. Select **Chart Selection**.
A list of available cartography is displayed.
3. Select the cartography type you want to display
The Chart window is re-drawn to show the select cartography type.

18.6 Vessel position on the chart display

Your current position is represented on-screen by the vessel symbol.

The vessel symbols are only displayed when heading or COG data is available.

The vessel symbol varies depending on selected settings and the availability of heading data.

	Motor Vessel	The motor vessel symbol is used when the vessel type selected during the initial set up wizard is a motor vessel.
	Sail Vessel	The sail vessel symbol is used when the vessel type selected during the initial set up wizard is a sail vessel.
	Small Vessel	The small vessel symbol is used when the Boat Size setting is set to Small.
	Black dot	A black dot is displayed when heading and COG data is not available.

Vessel position data can also be shown in the databar.



Locating your vessel

The vessel icon can be repositioned to the center of the screen by following the steps below.

1. Select the Find Ship icon:  located on the left hand side of the screen.



Locating your vessel

The vessel icon can be repositioned to the center of the screen by following the steps below.

1. Select **Menu**.
2. Select **Find Ship**.

18.7 Chart Orientation

The orientation of a chart refers to the relationship between the chart and the direction that you are travelling in.

Chart Orientation is used in conjunction with Motion Mode to control how your vessel and chart relate to one another and how they are displayed on-screen.

The mode you choose applies to the active Chart instance, and is restored at power up.

The following options are available:

North Up

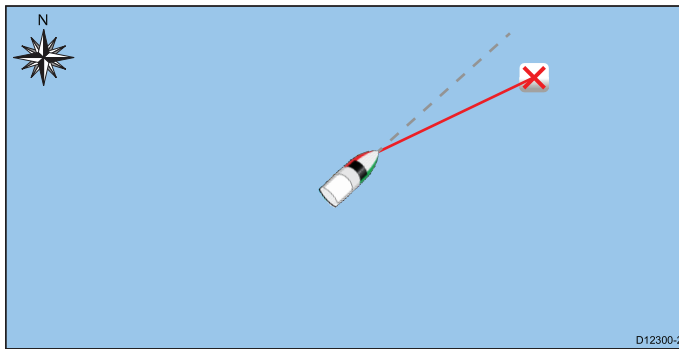

In **North Up** mode, the **Chart Orientation** is fixed with true north pointing up this is the (usual orientation of nautical charts). As your heading changes the vessel symbol rotates accordingly. This is the default orientation for the Chart application.

Head Up

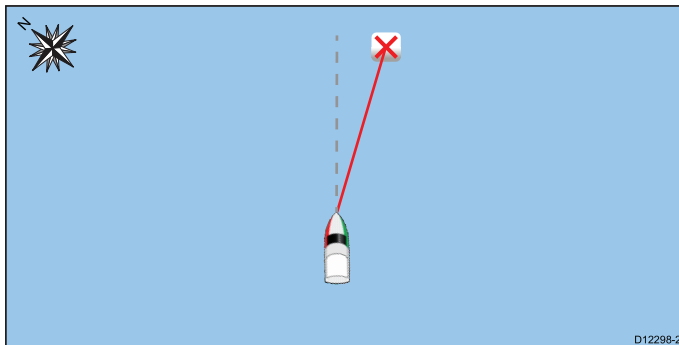

In **Head Up** mode, the Chart application displays the vessel's current Heading directly up. As the vessel Heading changes the vessel symbol remains fixed and the chart picture rotates accordingly. If Heading is not available then stable COG is used instead. If Heading or stable COG data is no longer present then the Orientation mode is suspended and the Chart application will display 0 degrees directly up if there is no active navigation or Course Up if there is active navigation.

Note: To prevent continuous backwards and forwards rotations as the vessel yaws from side-to-side, the chart will not update unless the heading changes by at least 10 degrees from the last displayed orientation.

Note: It is not possible to select **Head-Up** when the Motion Mode is set to True.

Course Up

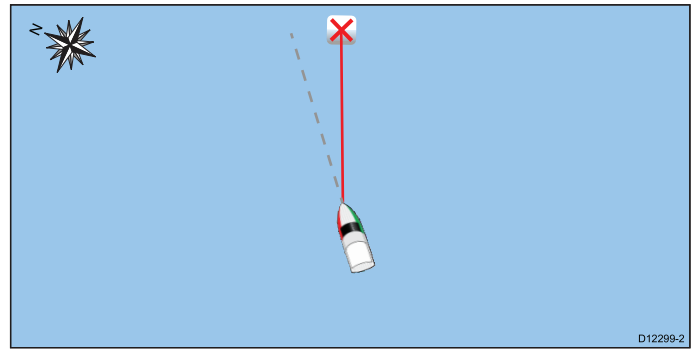

In **Course Up** mode, during active navigation, the Chart application displays the vessel's current destination waypoint directly up. When the destination waypoint changes the chart picture rotates accordingly. The reference used for Course Up depends upon the information available at a given time. The system always prioritizes this information in the following order:

1. Bearing Origin to waypoint
2. Locked heading from an Autopilot
3. BTW (Bearing To Waypoint)
4. Heading snapshot
5. Stable COG
6. North Up

If Heading or stable COG data is no longer present then the Orientation mode is suspended and the Chart application will display 0 degrees directly up if there is no active navigation or Course Up if there is active navigation.

Setting the chart orientation

From the Chart application menu:

1. Select **Presentation**.
2. Select **View & Motion**.
3. Select **Chart Orientation**.
4. Select Head Up, North Up (default), or Course Up option as appropriate.

Once selected the screen will update to reflect the new orientation.

18.8 Chart motion mode

The motion mode controls the relationship between the chart and your vessel.

Whilst motion mode is active, as your vessel moves, the chart is redrawn to keep the vessel on-screen. The 3 motion modes are:



- **Relative Motion (default)**
- **True Motion**
- **Auto Range.**

Note: In the 3D chart view, only Relative Motion mode is available.

The current motion mode applies to the active instance of the chart application.

When you pan the chart the motion mode is no longer active. This is indicated in the status bar by brackets around the motion mode — for example, (Relative Motion). This enables you to view another area of the chart whilst navigating. To reset the motion mode and return your vessel to the screen, select the **Find Ship** icon or select **Find Ship** from the menu. Manually changing the range or panning the chart in auto range also suspends motion mode. The default setting is relative motion with the boat icon positioned in the center of the screen. The mode that you select is restored at power up.

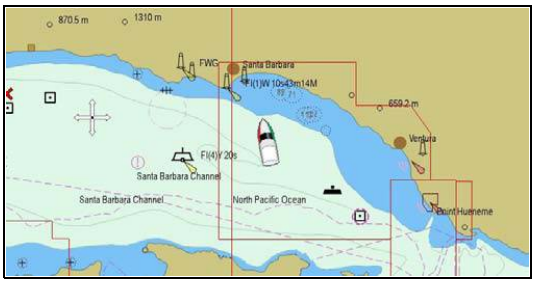
Boat positions (Relative Motion only)

Position	Example
Center	
Partial Offset	
Full Offset	

When the motion mode is set to Relative Motion, the position of your vessel is fixed on-screen and the chart picture moves relative to your vessel. You can use the **Menu > Presentation > View & Motion >**

Boat Position: menu options to determine whether the vessel is fixed in the center of the window or offset. If you change the position to Partial Offset or Full Offset, the view ahead of your vessel will be increased.

True Motion

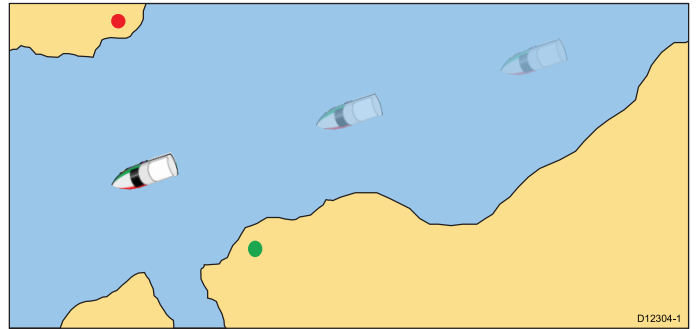

When the motion mode is set to True Motion, the chart is fixed and the vessel moves in true perspective to fixed landmasses on-screen. As the vessel's position approaches the edge of the screen, the chart picture is automatically reset to reveal the area ahead of the vessel.

Note: It is not possible to select True Motion when the orientation is set to Head Up.

Auto Range

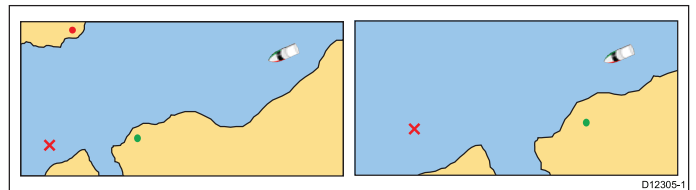

Auto Range selects and maintains the largest possible scale of chart that will display both the vessel and the target waypoint. Auto range is not available if radar-chart synchronization is on.

Setting the motion mode

To change the motion mode follow the steps below.

From the chart application menu:

1. Select **Presentation**.
2. Select **View & Motion**.
3. Select **Motion Mode**.
4. Select True Motion, Relative Motion, or Auto Range option as appropriate.

Once selected the screen will update to reflect the new mode.

Changing the position of the boat icon

From the chart application menu:

1. Select **Presentation**.
2. Select **View & Motion**.
3. Select **Boat Position**.
4. Select **Center**, **Partial Offset**, or **Full Offset** as appropriate.

18.9 Chart views

If supported by your cartography type, the Chart application can be set to either 2D or 3D view.

Selecting 2D and 3D chart views

You can switch between 2D and 3D views in the chart application if supported by your cartography. From the chart application menu:

1. Select **Presentation**.
2. Select **View & Motion**.
3. Select **Chart View** to select 2D or 3D.

2D chart view

The 2D chart view can display a range of information to help you navigate.

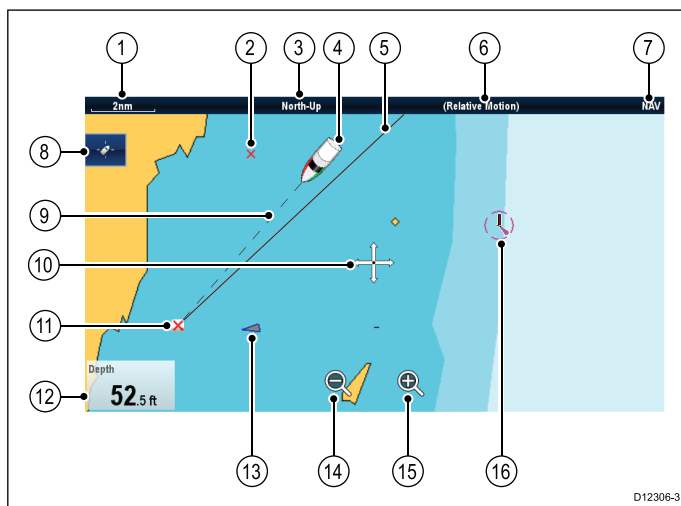

Item	Description
1	Range — horizontal chart scale indicator (shown in selected system units).
2	Waypoint — inactive.
3	Orientation — states the orientation mode that the chart is using (North-up, Head-up, or Course-up).
4	Vessel symbol — shows your current position.
5	Navigation origin line — during navigation, shows a solid line from the starting point to the target waypoint. The starting point can be the vessel's original location, the point of XTE reset or the point the current leg of a route was initiated.
6	Motion mode — states the current motion mode (Relative, True, or Auto Range).
7	Chart type — indicates the type of chart in use — Fish or Navigation.
8	Find ship icon — used to find and center your vessel on the chart.
9	Vessel position line — during navigation, shows a dotted line from the vessel's current position to the target waypoint.
10	Cursor — used to select chart objects and move around the chart area.
11	Target waypoint — current target waypoint.
12	Databoxes — used to display data such as depth on the chart screen.

Item	Description
13	AIS target — a vessel broadcasting AIS information (optional).
14	Range out — select icon to range out (Touchscreen displays only).
15	Range in — select icon to range in (Touchscreen displays only).
16	Cartographic objects — level of cartographic objects is determined by the cartography type.

3D chart view

The 3D view can display a range of information to help you navigate.

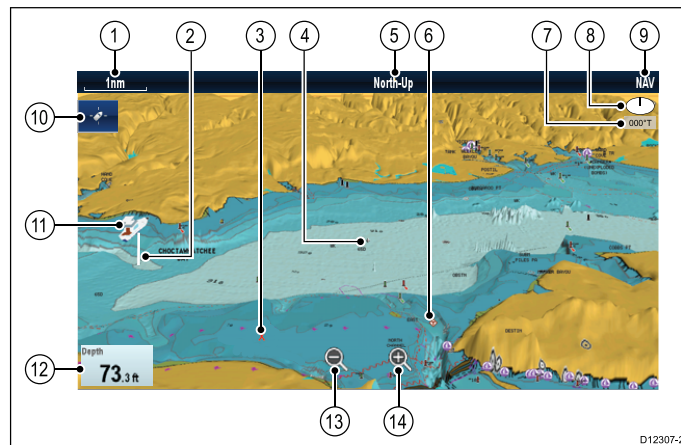

Item	Description
1	Range — horizontal chart scale indicator (shown in selected system units).
2	Depth Scale — approximate depth beneath your vessel (optional).
3	Waypoint — optional.
4	Center-of-view — the white cross indicates the center of chart view at the water level (optional).
5	Orientation — states the orientation mode that the chart is using.
6	Cartographic objects — use the Cartography Set-up menu to choose which objects to display.
7	Rotation — shows in degrees true, how far the on-screen view has been rotated from your vessel's heading and the tilt angle of your vessel.
8	North arrow — 3D indication of True North in relation to the chart view. The north arrow also tilts to indicate pitch angle.
9	Chart type — indicates the type of chart in use — Fish or Navigation.
10	Find ship icon — used to find and center your vessel on the chart.
11	Vessel symbol — your vessel's current position.
12	Data overlay — used to display data such as depth on the chart screen.

Item	Description
13	Range out — use icon to range out (Touchscreen displays only).
14	Range in — use icon to range in (Touchscreen displays only).

- **Depth Scale** — Switches on and off a depth scale at your vessel position.

Enabling center of view

In 3D view, to enable the center of view cross hair at sea level follow the steps below.

From the Chart application menu:

1. Select **Presentation**.
2. Select **View & Motion**.
3. Select **3D Display Options**.
4. Select **Center of View** so that On is highlighted. Selecting centre of view will switch the cross hair on and off.

Adjusting the 3D exaggeration

In the 3D chart view.

From the Chart application menu:

1. Select **Presentation**.
2. Select **View & Motion**.
3. Select **3D Display Options**.
4. Select **Exaggeration**:
The Exaggeration numeric adjust control is displayed.
5. Adjust the numeric adjust control to the required setting, between 1.0 and 20.0
6. Select **Ok** or **Back** to confirm the setting and close the numeric adjust control.

Enabling transducer cone

In 3D view, to enable the transducer cone which indicates the coverage of your fishfinder transducer follow the steps below.

From the Chart application menu:

1. Select **Presentation**.
2. Select **View & Motion**.
3. Select **3D Display Options**.
4. Select **Transducer Cone** so that On is highlighted. Selecting Transducer cone will switch the function on and off.

Enabling depth scale

In 3D view, to enable a depth indicator at your vessel's location follow the steps below.

From the Chart application menu:

1. Select **Presentation**.
2. Select **View & Motion**.
3. Select **3D Display Options**.
4. Select **Depth Scale**: so that On is highlighted. Selecting depth scale will switch depth indicator on and off.

Manipulating the 3D chart view

From the chart application:

1. With the chart in 3D mode, go to the Adjust Viewing Angle menu: **Menu > Adjust Viewing Angle**.
2. Select **Adjust**: so that Pitch and rotate is highlighted.
3. To adjust the pitch:
 - i. Non-touchscreen or HybridTouch displays — Move the **Joystick Up** or **Down** to adjust the pitch
 - ii. HybridTouch or Touch only displays — Swipe your finger up or down across the screen to adjust the pitch.

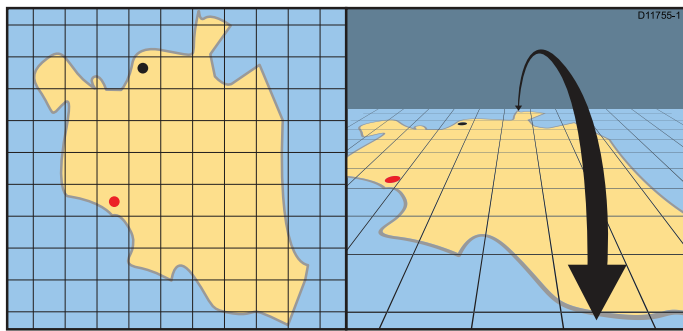

4. To adjust the rotation:
 - i. Non-touchscreen or HybridTouch displays — Move the **Joystick Left** or **Right** to adjust the rotation
 - ii. HybridTouch or Touch only displays — Swipe your finger left or right across the screen to adjust the rotation.

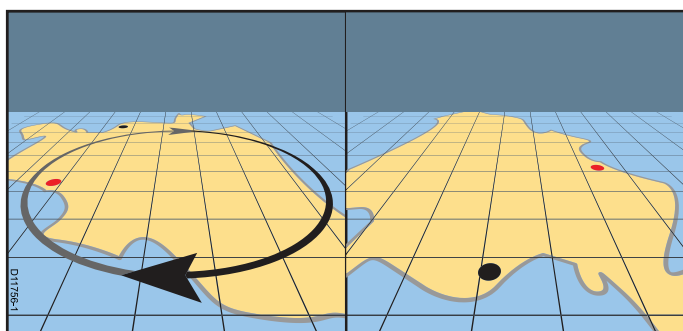

3D Display Options

The following options are available with the Chart application in 3D view:

- **Center Of View** — Switches a cross hair on and off at the center of the screen at sea level.
- **Exaggeration** — Adjusting the exaggeration has the effect of vertically stretching objects on the chart, making it easier to see their shape and position.
- **Transducer Cone** — Switches on and off a transducer cone indicating the coverage of a fishfinder transducer.

18.10 Chart display

The Chart Display menu option determines the level of detail that is displayed on-screen.

The Chart display menu option is only available when using vector based cartography.

The Chart display options are shown below.

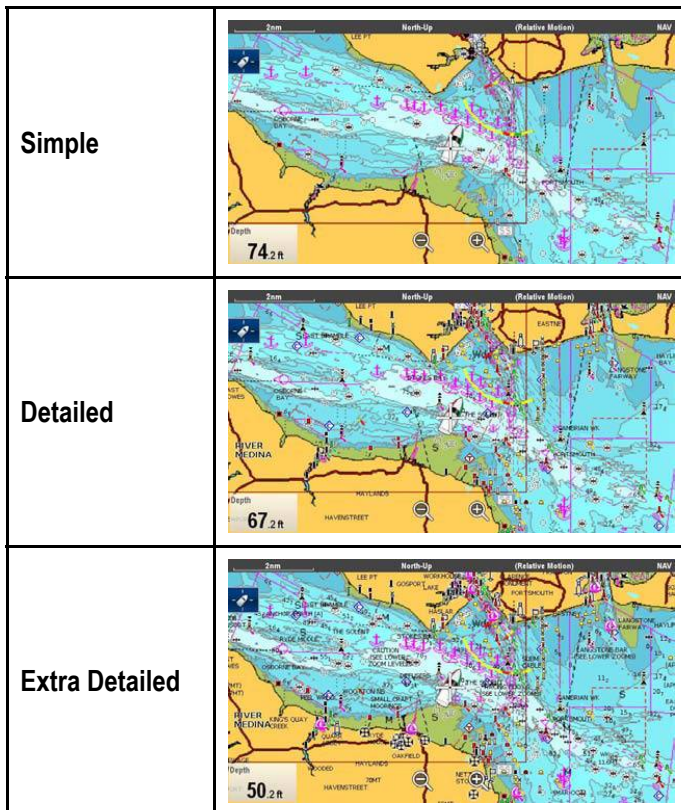

The level of detail shown on-screen is also affected by the cartography **Chart detail** settings. Refer to [Chart detail](#) for information.

Changing the chart display detail

From the Chart application menu:

1. Select **Presentation**.
2. Select **Chart Detail**.

The following options are available:

- Simple
 - Detailed
 - Extra Detailed
3. Select the required option.

18.11 Overlays

The chart has a number of overlays that display different views and information. The overlays require electronic charts with the appropriate feature support and may also require additional hardware and service subscriptions.

You can overlay the following data onto a 2D chart to give greater depth of information. The overlays available are:

- * **AIS** — View and track AIS targets. This overlay is not available in 3D view.
- * **Radar** — Overlay radar onto the chart. This overlay is not available in 3D view.
- ** **Aerial** — Provides an aerial / satellite photography overlay.
- ** **Aerial Overlay:** — Determines the coverage of the aerial overlay.
- * **NOWRad** — Provides the NOWRad weather radar overlay. This overlay is not available in 3D view.
- **Databoxes** — Select whether databoxes are displayed on-screen and what data is displayed.
- **Chart Grid** — Determines whether grid lines representing longitude and latitude are displayed on the chart.
- ** **2D Shading** — Determines whether terrain shading is displayed in 2D view.
- ** **Community Edits** — Determines whether the community layer is enabled or disabled.
- ** **Chart Text** — Determines whether chart text is displayed (place names and so on).
- **Chart Boundaries** — Determines whether a line indicating the chart boundary is displayed.
- **Range Rings**— View range rings in the Chart application. This overlay is not available in 3D view.
- **Safe Zone Ring** — View safe zone ring. This overlay is not available in 3D view.
- **Fuel Range Ring** — View the fuel range ring. This overlay is not available in 3D view.
- **Boat Size** — Determines the size of the boat icon on-screen.
- **Waypoint Name** — Determines whether the Waypoint names are displayed next to waypoints.
- **Route Width** — Determine the width of route lines on-screen.
- **Track Width** — Determine the width of track lines on-screen.

Note:

- * Additional hardware required.
- ** If supported by your cartography type.

Enabling AIS in the Chart application

To enable the AIS overlay in the Chart application follow the steps below.

To enable the AIS overlay your system must include an AIS receiver or transceiver. The AIS overlay is not available in 3D view.

From the Chart application menu:

1. Select **Presentation**.
2. Select **Overlays**.
3. Select **AIS**: so that On is selected.
Selecting AIS: switches the AIS between On and Off.

For AIS information refer to [Chapter 16 AIS function](#).

Radar overlay

You can overlay Radar and MARPA functions in the Chart application to provide target tracking or to help you distinguish between fixed objects and other marine traffic.

You can enhance the use of the Chart application by combining it with the following Radar features:

- **MARPA** — The Mini Automatic Radar Plotting Aid (MARPA) function is used for target tracking and risk analysis. MARPA targets are only available in the Chart application when Heading data is available. When MARPA targets are being tracked they are displayed in the Chart application regardless of whether Radar overlay is switched On. Associated MARPA functions can be accessed using the menu.
- **Radar overlay** — You can overlay the Radar image over your Chart image allowing better distinction between fixed objects and other marine traffic. For best results, switch on Radar-Chart synchronization to ensure radar range and chart scale are synchronized.



Radar overlay using Heading

Radar overlay requires the use of Heading data from a connected:

- Evolution autopilot sensor (such as the EV-1 or EV-2, or
- Fluxgate compass

With Heading data available both Radar overlay and MARPA targets can be displayed in the Chart application.

The system will always use Heading for the overlay when it is available.

When the Radar overlay is using Heading then 'OVL' is displayed in the top left corner of the Chart application.

Radar overlay using stable COG

Radar overlay can be set to use COG when Heading data is not available or is lost. In order to use COG for the overlay it must be stable i.e. there must be sufficient SOG.

When using COG for the overlay MARPA targets are not available.

If Heading data becomes available then the overlay will automatically switch back to using Heading instead.

When the Radar overlay is using COG then 'OVL-COG' is displayed in the top left corner of the Chart application.

Note: When the overlay is using COG, misalignment of the Radar and Chart images can occur due to tide and current effects.

Enabling Radar overlay

With a connected Radar turned On and Transmitting:

1. Select **Menu**.
2. Select **Presentation**.
3. Select **Overlays**.
4. Select **Radar**.
The Radar overlay opacity slider bar control is displayed showing the current opacity percentage.
5. Adjust the slider bar to the required opacity, or
6. Select **Off** to turn the Radar overlay off.
7. Select **Back** to close the opacity menu.

Note: Radar overlay is not available in 3D view.

Using COG for the Radar overlay

COG can be used for the Radar overlay when Heading data is not available or is lost.

From the Chart application menu, with Radar overlay switched On:

1. Select **Menu**.
2. Select **Presentation**.
3. Select **Overlays**.
4. Select **Radar w/o Hdg**: so that On is highlighted.
The Radar overlay is now set to automatically switch to use COG data if Heading data is not available or is lost. If Heading data subsequently becomes available again the system will automatically change back to using Heading data. An alert message will be displayed when switching to COG.

Note: When the overlay is using COG, misalignment of the Radar and Chart images can occur due to tide and current effects.

Accessing radar controls on the chart

From the chart application:

1. Select **Menu**.
2. Select **Radar Options** or **Radar & AIS Options**.

Note: Any changes made to the radar options from the chart application will be applied to the radar application.

Chart scale and radar range synchronization

You can synchronize the radar range in all radar windows with the chart scale.

When synchronization is switched on:

- The radar range in all radar windows changes to match the chart scale.
- 'Sync' is indicated in the top left-hand corner of the chart window.
- If you change the radar range, in any radar window, all synchronized chart views change scale to match.
- If you change the scale of a synchronized chart window, all radar windows change range to match.

Synchronizing the chart and radar range

In the 2D chart view:

1. Select **Menu**.
2. Select **Presentation**.
3. Select **View & Motion**
4. Select **Chart Sync**.
5. Select **Radar**.

Note: Radar range synchronization is not available when the chart motion mode is set to Auto Range.

Aerial photo overlay

Your electronic charts may include aerial photography.



Aerial photos cover the navigable waters up to 3 miles inside the coastline. The resolution is dependent on the region covered by the chart card.

Enabling aerial photo overlay

From the chart application:

1. Select **Menu**.
2. Select **Presentation**.

Chart application

3. Select **Overlays**.

4. Select **Aerial**.

The aerial opacity slider bar control is displayed showing the current opacity percentage.

5. Adjust the slider bar to the required opacity, or
6. Select **Off** to turn the aerial overlay off.

Specifying the aerial overlay area

From the Chart application menu:

1. Select **Presentation**.

2. Select **Overlays**.

3. Select **Aerial Overlay**:

A list of overlay options is displayed.

4. Select either **On Land**, **On Land and Shallows**, or **On Land and Sea**.

The chart display is redrawn showing the new overlay selection.

NOWRad weather overlay

With a suitable weather receiver connected to your multifunction display, you can overlay NOWRad weather information on the chart display.

The NOWRad weather overlay provides NOWRad weather information and reports in the chart application. You can adjust the intensity of the overlay to achieve optimal visibility of both chart and weather information.

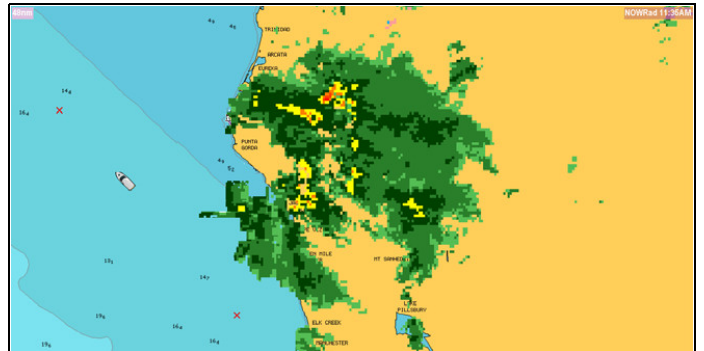

Note: The NOWRad weather overlay can only be used in North America and its coastal waters.

Enabling NOWRad weather overlay on the chart

In the 2D chart view:

1. Select **Menu**.
2. Select **Presentation**.
3. Select **Overlays**.
4. Select **NOWRad**.

The NOWRad opacity slider bar control is displayed showing the current opacity percentage.

5. Adjust the slider bar to the required opacity, or
6. Select **Off** to turn the NOWRad overlay off.

Viewing weather reports from the chart application

In the 2D chart view:

1. Select **Menu**.
2. Select **Weather Reports**.
3. Select **Report At** to switch between weather reports from **Ship** or **Cursor** location.

- Select either Tropical Statements, Marine Warnings, Marine Zone Forecasts, or Watchbox Warnings.

Databoxes

Databoxes can be displayed in the application window.

The databoxes can be switched on and off and the data that is displayed can be customized.



Customizing databoxes in the chart application

To switch databoxes on and off and to select data to display follow the steps below.

From the Chart application menu:

- Select **Presentation**.
- Select **Overlay**.
- Select **Databoxes**.
- Select **Databox 1 > On**.
- Select **Databox 2 > On**.
- Choose the **Select Data** option for the relevant databox.
- Select the category that reflects the type of data you want to display in the databox. For example, Depth data.
- Select the data item.
The data you selected is displayed onscreen in the appropriate databox.

Chart grid

You can overlay a grid onto the Chart application

The Chart grid represents the lines of latitude and longitude.



By default the Chart grid is switched off.

Switching the chart grid on and off

The Chart grid can be switched on and off by following the steps below.

From the Chart application menu:

- Select **Presentation**.
- Select **Overlays**.
- Select **Chart Grid**: so that On is selected to turn the grid on, or
- Select **Chart Grid**: so that Off is selected to turn the grid off.

2D shading

If supported by your cartography type, you can switch shading of land and sea contours on and off.

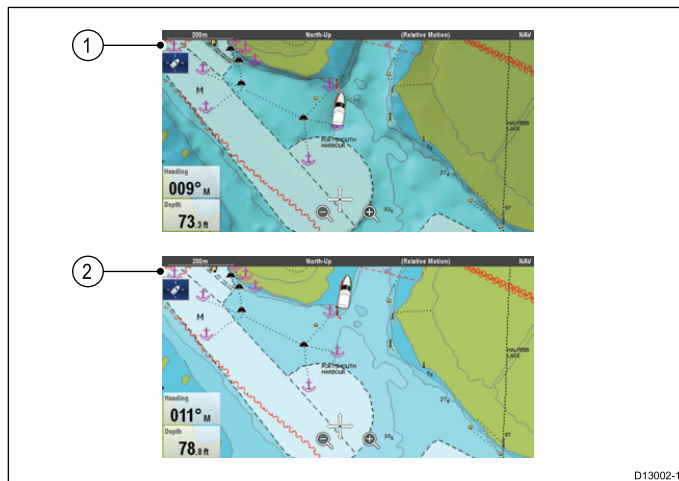

- 2D shading On.
- 2D shading Off

By default 2D shading is switched on.

Switching 2D shading on and off

2D shading can be switched on and off by following the steps below.

From the Chart application menu:

- Select **Presentation**.
- Select **Overlays**.
- Select **2D Shading**: so that On is selected to turn the shading on, or
- Select **2D Shading**: so that Off is selected to turn the shading off.

Community layer

If supported by your cartography type, you can display User Generated Content (UGC) on the Chart application.

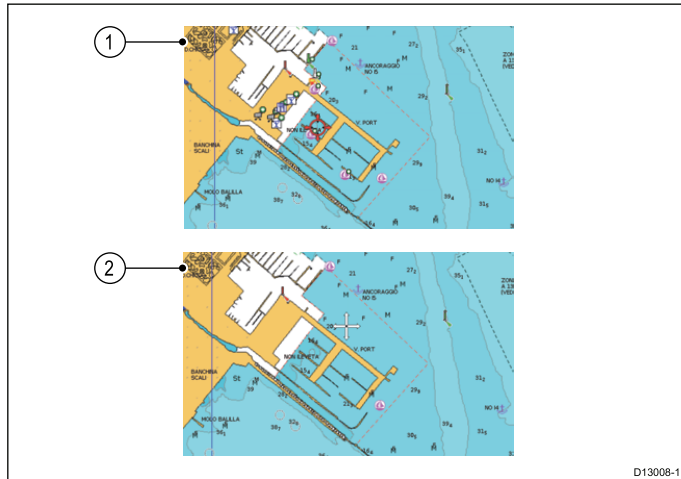

1. Community feature On.
2. Community feature Off.

To check if your Navionics cartography supports community edits downloads please refer the Navionics website: for information and instructions on downloading the updates to your chart card.

Switching the community edits on and off

If supported by your cartography type, the User Generated Content (UGC) overlay can be switched on and off by following the steps below.

From the Chart application menu:

1. Select **Presentation**.
2. Select **Overlays**.
3. Select **Community Edits**: so that On is selected to display UGC, or
4. Select **Community Edits**: so that Off is selected to turn off UGC.

Chart text

If supported by your cartography type, chart text such as place names and caution text etc. can be switched on and off.

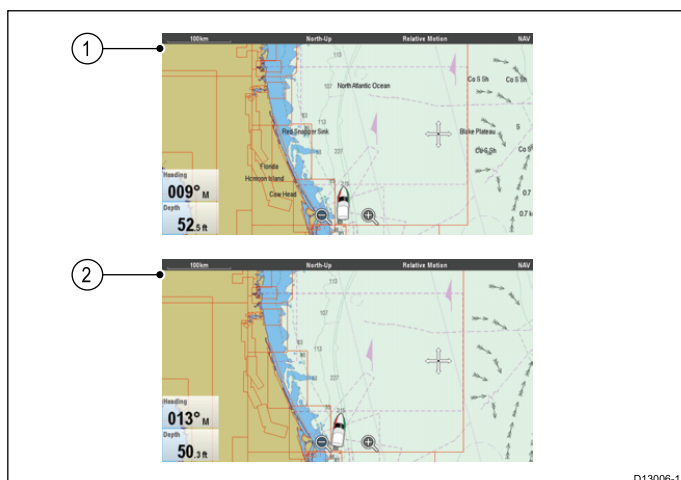

1. Chart text On.
2. Chart text Off.

The default setting for Chart text is On.

Chart application

Switching chart text on and off

The Chart text can be switched on and off by following the steps below.

From the Chart application menu:

1. Select **Presentation**.
2. Select **Overlays**.
3. Select **Chart Text**: so that On is selected to turn chart text on, or
4. Select **Chart Text**: so that Off is selected to turn chart text off.

Chart boundaries

Chart boundary lines can be shown on-screen, these lines indicate the boundary of the cartography currently in use.

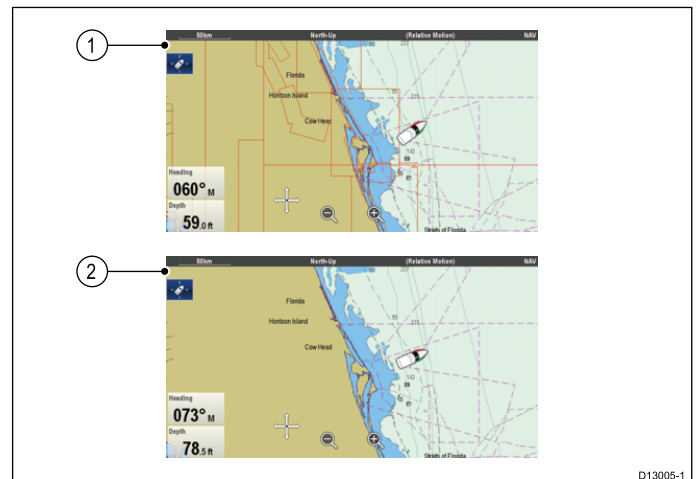

1. Chart boundaries On.
2. Chart boundaries Off.

By default Chart boundary lines are switched On.

Switching chart boundary lines on and off

Chart boundary lines can be switched on and off by following the steps below.

From the Chart application menu:

1. Select **Presentation**.
2. Select **Overlays**.
3. Select **Chart Boundaries**: so that On is selected to display boundary lines, or
4. Select **Chart Boundaries**: so that Off is selected to turn the boundary lines off.

Range rings

Range rings provide an on-screen incremental representation of distance from your vessel to help you judge distances at a glance.

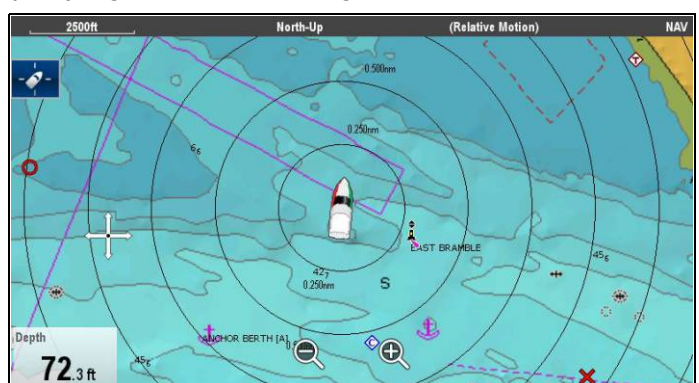

The rings are always centred on your vessel, and the scale varies to suit your current chart range. Each ring is labelled with the distance from your vessel.

By default range rings are switched off. Range rings are not displayed in 3D view.

Switching range rings on and off

The range rings can be switched on and off by following the steps below.

With the Chart application in 2D view:

1. Select **Menu**.
2. Select **Presentation**.
3. Select **Overlays**.
4. Select **Range Rings**: so that On is selected to display Range Rings, or
5. Select **Range Rings**: so that Off is selected to turn the Range Rings off.

Safe Zone Ring

The chart application can display and configure a MARPA / AIS safe zone ring.

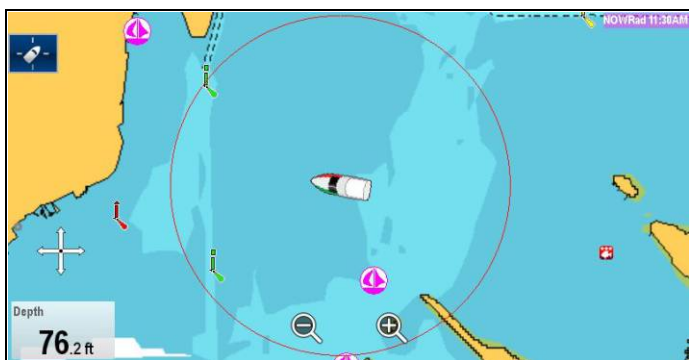

The safe zone ring shares its configuration with the Radar applications safe zone ring, however can be displayed independently of the safe zone ring in the Radar application.

If a MARPA or AIS target will reach the safe zone ring within the time to safe zone selected an alarm is sounded.

Showing the Safe Zone Ring in the Chart application

To show the Safe Zone ring follow the instructions below:

From the Chart application:

1. Select **Menu**.
2. Select **Presentation**.
3. Select **Overlays**.
4. Select **Safe Zone Ring** so that **Show** is selected.
Selecting Safe Zone Ring will switch the zone ring between hidden to visible.

Setting up the Safe Zone Ring

You can adjust the Safe Zone Ring radius, the time to Safe Zone and choose whether AIS targets trigger the Safe Zone alarm from the Safe Zone Ring Set-up menu.

The Safe Zone Set-up menu can be accessed as follows:

- From the Radar application: **Menu > Zones > Safe Zone Set-up**.
- From the Chart application with only the AIS overlay enabled: **Menu > AIS Options > Safe Zone > Safe Zone Set-up**.
- From the Chart application with only the Radar overlay enabled: **Menu > Radar Options > Safe Zone > Safe Zone Set-up**.
- From the Chart application with the AIS and Radar overlays enabled: **Menu > Radar & AIS Options > Safe Zone > Safe Zone Set-up**.

From the Safe Zone Set-up menu:

1. Select **Safe Zone Radius**.
 - i. Select the required radius for the safe zone.
2. Select **Time to Safe Zone**.
 - i. Select the required time period.
3. Select **Safezone (AIS targets)** so that On is highlighted.

Selecting Safezone (AIS targets) will switch the dangerous target alarm between On and Off.

Fuel range rings

The fuel range ring gives an estimated range that can be reached with the estimated fuel remaining on-board.

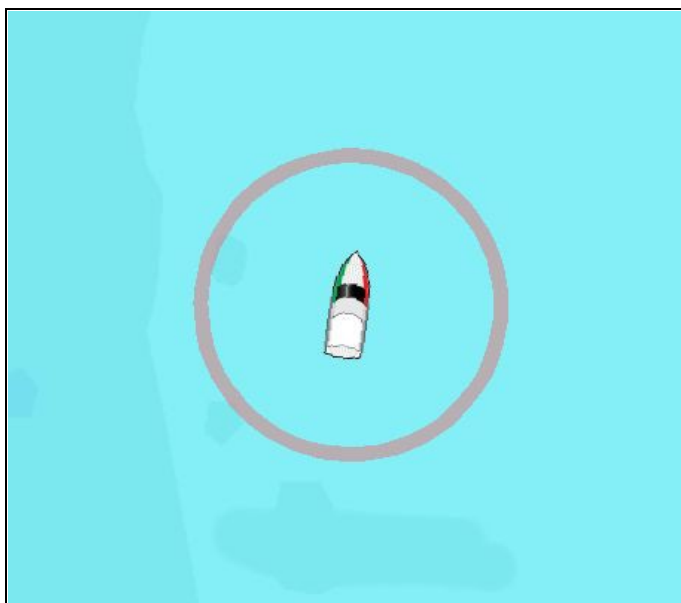

The fuel range ring can be displayed graphically in the chart application and indicates an estimated range that can be reached with the:

- Current rate of fuel consumption.
- Estimated fuel remaining on-board.
- Course remaining in a straight line.
- Current speed maintained.

Note:

The fuel range ring is an estimated range that can be reached at the current rate of fuel consumption, of the fuel onboard and based on a number of external factors which could either extend or shorten the projected range.

This estimate is based on data received from external fuel management devices, or via the Fuel Manager. It does not take into account prevailing conditions such as tide, current, sea state, wind etc.

You should not rely on the fuel range ring feature for accurate voyage planning or in emergency and safety critical situations.

Enabling the fuel range ring

From the chart application, in 2D view:

1. Select **Menu**.
2. Select **Presentation**.
3. Select **Overlays**.
4. Select **Fuel Range Ring** so that On is selected. The fuel range ring pop-up message is displayed.
5. Select **OK** to turn on the fuel range rings.

Disabling the Fuel Range Ring

From the chart application, in 2D view:

1. Select **Menu**.
2. Select **Presentation**.
3. Select **Overlays**.
4. Select **Fuel Range Ring** so that Off is selected.

Changing the size of the vessel symbol

The vessel symbol size can be changed following the steps below.

From the Chart application menu:

1. Select **Presentation**.
2. Select **Overlays**.
3. Select **Boat Size**: so that Large is selected to show the large vessel symbols, or
4. Select **Boat Size**: so that Small is selected to show the small vessel symbol.

Displaying waypoint names

Waypoint names can be shown next to their respective waypoint symbols.

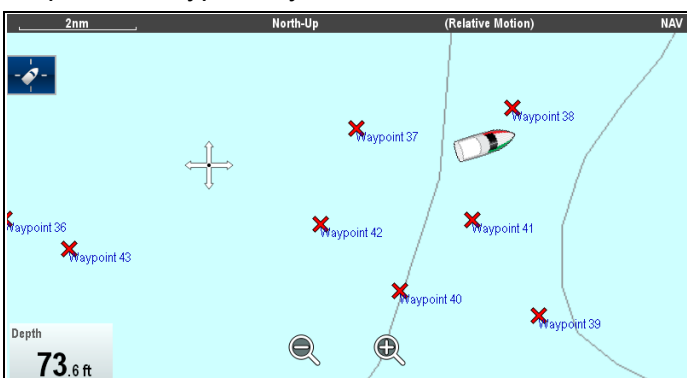

From the Chart application menu.

Chart application

1. Select **Presentation**.
2. Select **Overlays**.
3. Select **Waypoint Name**: so that Show is selected to display the waypoint names, or
4. Select **Waypoint Name**: so that Hide is selected to hide the waypoint names.

Route and Track widths

The width of route and track lines can be changed.

Set-ting	Route	Track
Thin		
Normal		
Thick		

Changing route or track line widths

The width of the line that make up routes and tracks can be changed by following the steps below.

From the Chart application menu.

1. Select **Presentation**.
2. Select **Overlays**.
3. Select either **Route Width** or **Track Width** as required.
4. Select the width you require from the list.

18.12 Chart vectors

Chart vectors are available for heading, COG, wind direction and tide direction. Chart vectors are only available in 2D view.

A range of vector graphics can be displayed in the chart application when in 2D chart view. The following vectors can be independently enabled or disabled:

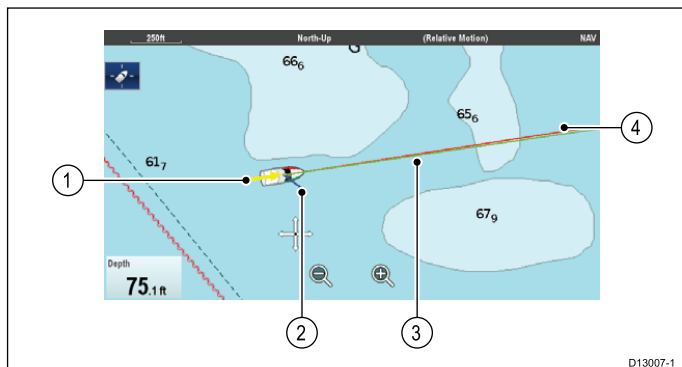

Item	Descriptions
1	Wind arrow — wind direction is displayed as a yellow line with solid arrow heads pointing towards your vessel, indicating the wind direction. The width of the arrow indicates the wind strength.
2	Tide arrow — tide is displayed as a blue line with solid arrow head pointing away from your vessel, in the direction of the tidal set. The width of the arrow indicates the tide strength.
3	HDG (heading) vector — a red line shows the vessel's heading. An arrow head is used if the vector length is set to a value other than infinite.
4.	COG (Course Over Ground) vector — a green line indicates the vessel's actual course. A double arrow head is used if the vector length is set to a value other than infinite.

Note: If Speed Over Ground (SOG) or heading data is not available, vectors cannot be displayed.

Vector length

The length of the HDG and COG vector lines can be set to the distance your vessel will travel in the time you specify at your current speed or they can be set to infinite.

Enabling and disabling chart vectors

You can enable and disable the available chart vectors by following the steps below.

In 2D chart view:

From the Chart application menu:

1. Select **Presentation**.
2. Select **Vectors**.
3. Select the relevant menu item to switch **Heading Vector**, **COG Vector**, **Tide Arrow**, or **Wind Arrow** On or Off as appropriate.

Setting vector length and width

You can specify the length and width of the heading and COG vectors by following the steps below.

In 2D chart view.

From the Chart application menu:

1. Select **Presentation**.
2. Select **Vectors**.
3. Select **Vector Length**.
A list of times is displayed .
4. Select a time setting or select Infinite.
5. Select **Vector Width**.
A list of widths is displayed.
6. Select either Thin, Normal or Wide.

18.13 Cartography objects

Chart detail

The chart detail setting determines the amount of detail shown in the Chart application.

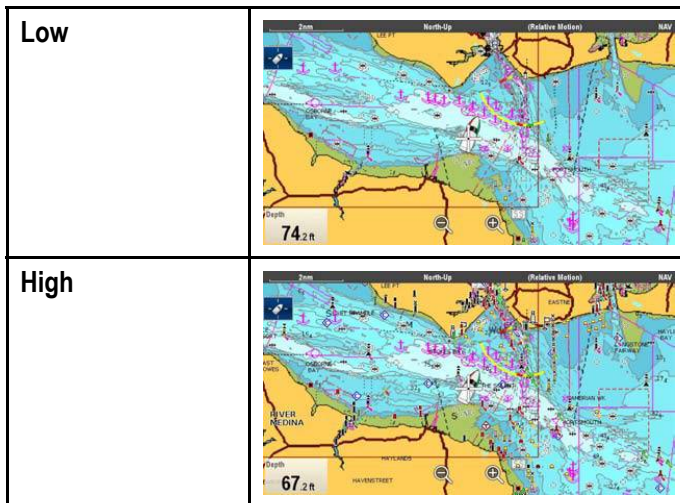

Selecting the Low option for the **Chart Detail** disables the following objects and overlays:

- 2D Shading
- Community Edits
- Chart Text
- Chart Boundaries
- Light Sectors
- Routing Systems
- Caution Areas
- Marine Features
- Land Features
- Panoramic Photo
- Roads
- Additional Wrecks
- Color Seabed Areas
- Depth Contours

Changing the level of chart detail

From the chart application menu:

1. Select **Presentation**.
2. Select **Objects**.
3. Select **Chart Detail** to switch between High or Low, as appropriate.

Cartography objects

If supported by your cartography type, cartographic objects can be individually switched on and off. The table below shows a list of these objects.

The Objects menu is accessed from: **Menu > Presentation > Objects**.

Note: The Objects menu is only available when the cartography in use supports these features.

Object (Menu item)	Description	Options
Show Rocks	Determines the depth at which rocks are displayed in the chart application.	<ul style="list-style-type: none"> • 0–6 ft / 0–2 m / 0–1 fa • 0–18 ft / 0–5 m / 0–3 fa • 0–30 ft / 0–10 m / 0–5 fa • 0–50 ft / 0–15 m / 0–8 fa • 0–60 ft / 0–20 m / 0–10 fa • All (default)
Nav. Marks	Determines whether navigation marks are displayed on the chart: <ul style="list-style-type: none"> • Off — navigation marks are NOT displayed. • On — navigation marks are displayed. 	<ul style="list-style-type: none"> • Off • On (default)
Nav. Mark Symbols	Determines which set of navigation mark symbols is used — International, or US. These symbols correspond to paper charts.	<ul style="list-style-type: none"> • International (default) • US
Light Sectors	Determines whether the sector of light cast by a fixed beacon is displayed or not. <ul style="list-style-type: none"> • Off — sector of light is NOT displayed. • On — sector of light is displayed. 	<ul style="list-style-type: none"> • Off • On (default)
Routing Systems	Determines whether routing data is displayed or not. <ul style="list-style-type: none"> • Off — routing data is NOT displayed. • On — routing data is displayed. 	<ul style="list-style-type: none"> • Off • On (default)
Caution Areas	Determines whether caution data is displayed or not. <ul style="list-style-type: none"> • Off — caution data is NOT displayed. • On — caution data is displayed. 	<ul style="list-style-type: none"> • OFF • ON (default)
Marine Features	When this menu item is set to On, the following water-based cartographic features are displayed: <ul style="list-style-type: none"> • Cables. • Nature of seabed points. • Tide stations. • Current stations. • Port information. 	<ul style="list-style-type: none"> • Off • On (default)
Land Features	When this menu item is set to On, land-based cartographic features are displayed.	<ul style="list-style-type: none"> • Off • On (default)
Business Services	When this menu item is set to On, symbols indicating the location of a business will be shown.	<ul style="list-style-type: none"> • Off • On (default)
Panoramic Photos	Determines whether panoramic photos are available for landmarks such as ports and marinas.	<ul style="list-style-type: none"> • Off • On (default)

Object (Menu item)	Description	Options
Roads	Determines whether major coastal roads are displayed on the chart: <ul style="list-style-type: none"> • Off — coastal roads are NOT displayed. • On — coastal roads are displayed. 	<ul style="list-style-type: none"> • Off • On (default)
Additional Wrecks	Determines whether extended information for new wrecks is displayed.	<ul style="list-style-type: none"> • Off • On (default)
Colored Seabed Areas	Provides greater definition of the seabed. This applies only to limited areas where the extra detail is available.	<ul style="list-style-type: none"> • Off (default) • On

18.14 Object information

If supported by your cartography type, you can view detailed information about specific cartographic objects.

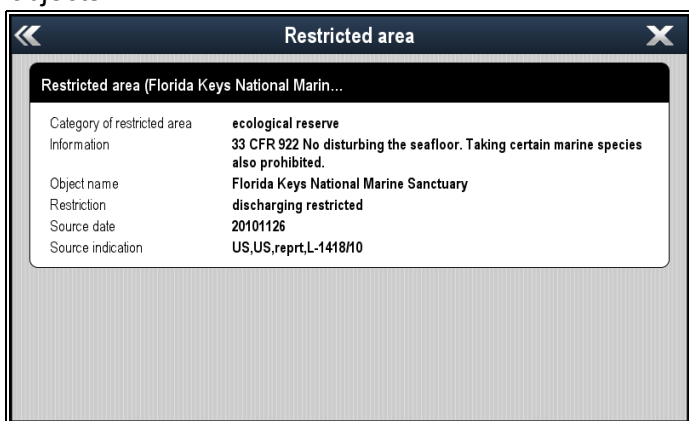

Depending on the cartography type you are using, you can view some or all of the following additional information:

- Details of each cartographic object that is marked on the chart, including source data for structures, lines, open sea areas etc.
- Details of ports, port features, and business services.
- Pilot book information (similar to what you would see in a marine almanac). Pilot book information is available at certain ports.
- Panoramic photos of ports and marinas. The availability of photos is indicated by a camera symbol on the chart display.

You can also search for the nearest instance of a particular chart object using the **Find Nearest** option. The following object can be searched for:

- **Port (Search by name)** — Navionics charts only.
- **Waypoints**
- **Ports** — Navionics charts only.
- **Tide Station** — Navionics charts only.
- **Current Station** — Navionics charts only.
- **Obstructions**
- **Wrecks**
- **Port Services**
- **Business Services** — Navionics charts only.
- **Small Craft Facility** — LightHouse charts only.

- **Harbor Facility** — LightHouse charts only

This information can be accessed using the **Chart Objects** or **Find Nearest** options from the chart context menu:

- Select a chart object on screen and choose **Chart Objects** from the chart context menu to view information about the selected object.
- Select **Find Nearest** from the chart context menu to search for objects close by.

Displaying chart object information

From the chart application:

1. Select an object.
The chart context menu is displayed.
2. Select **Chart Objects**.
The Chart Object Dialog is displayed.
3. Selecting available options will display detailed information about that item.
4. Selecting the position in the dialog will close the information dialog and position the cursor over the object.

Searching for the nearest chart object or service

From the chart application:

1. Select a location on screen.
The chart context menu is displayed.
2. Select **Find Nearest**.
A list of chart object types is displayed.
3. Select the chart object or service in the list.
A list is displayed of the available instances of that particular object or service.
4. Select the item that you want to find.
The cursor will be repositioned over the selected object or a list of instance will be displayed.

Searching for a port by name

From the chart application:

1. Select a location on screen.
The chart context menu is displayed.
2. Select **Find Nearest**.
A list of chart object types is displayed.

3. Select **Port (search by name)** from the list.
The on-screen keyboard is displayed.
4. Use the on-screen keyboard to enter the desired port name.
5. Select **SAVE**.
The search results are displayed.
6. Select the position against an entry in the list to reposition the cursor over that position.

Displaying pilot book information

From the chart application, when a port symbol is displayed for a port which has a pilot book:

1. Select the port symbol.
The chart context menu will be displayed.
2. Select **Pilot Book**.
3. Select the relevant chapter.

Displaying panoramic photos

From the chart application, when a camera symbol is displayed, indicating the availability of a photo:

1. Select the camera symbol.
The chart context menu is displayed.
2. Select **Photo**.
The photo is displayed on screen.

Note: Not all cartography types are capable of displaying panoramic photos.

Current information

Animated current information

The electronic charts may allow animation of the current information current stations.

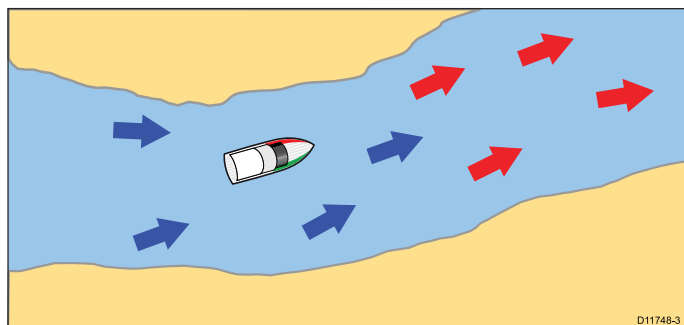

Animated current information is available in the chart application wherever a diamond-shaped symbol with a "C" is displayed:

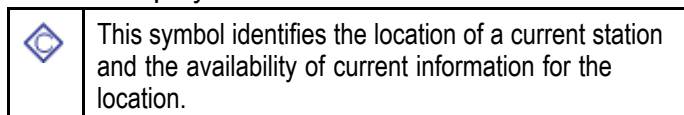

When you select a current station symbol the chart context menu is displayed, which provides the **Animate** option.

When you select **Animate** the animate menu is displayed and the diamond-shaped current symbols are replaced with dynamic current arrows which indicate the direction and strength of the currents:

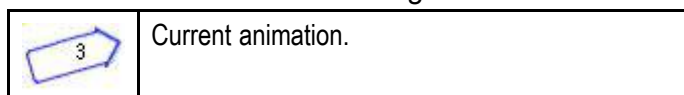

- Arrows indicate the direction of current flows.
- The length of the arrow indicates the flow rate.
- The color of the arrow indicates the flow speed:
 - **Red:** increasing current flow speed.
 - **Blue:** decreasing current flow speed.

The animation can be viewed continuously or incrementally at a time interval that you specify. You can also set the date for the animation, and start or restart the animation at any point within a 24-hour period. If the system does not have a valid date and time the date used will be midday for the system default date.

Note: Not all electronic charts support the animated currents feature. Check the Navionics website: www.navionics.com to ensure the features are available on your chosen cartography level.

Viewing animated current information

From the chart application:

1. Select diamond-shaped current icon.
The chart context menu is displayed.
2. Select **Animate**.
The animate menu is displayed and the current icons are replaced with dynamic current arrows

Controlling animations

From the chart application, with the animate menu displayed:

1. To start or stop the animation, select **Animate:** to switch between Play and Pause.
2. To view the animation in steps, select **Step Back** or **Step Forward**.
3. To set the animation step interval, pause any playing animations, and then select **Set Time Interval**.
4. To set the animation date, select **Set Date** and then using the on screen keyboard enter the required date.
5. To set the animation date to the current date select **Today**.
6. To set the animation date to 24 hours previous to the current date select **Previous Day**.
7. To set the animation date to 24 hours ahead of the current date select **Next Day**.

Current graphs

Current graphs provide a graphical view of current activity.

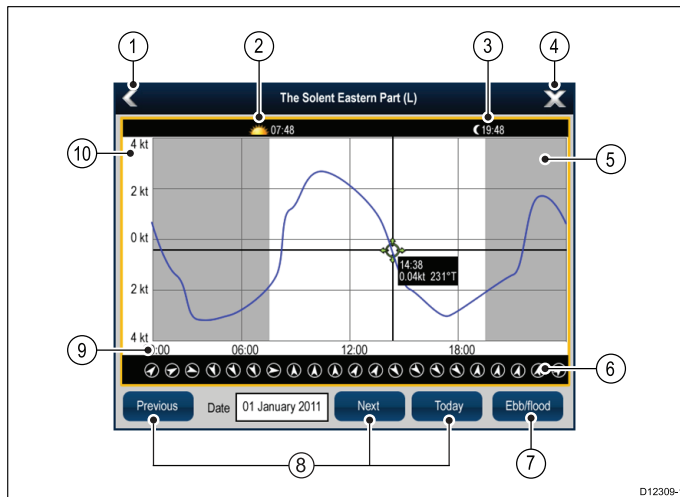

1. **Back** — Return to the previous menu or view.
2. **Sunrise indicator** — Indicates when the sun rises.
3. **Sunset indicator** — Indicates when the sun sets.
4. **Exit** — Closes the dialog.
5. **Nightfall indicator** — The greyed-out section of the graph indicates when nightfall occurs.
6. **Current direction** — Indicates the direction of current (relative to north).
7. **Ebb/Flood** — Displays a list showing ebb, slack and flood tides.
8. **Date navigation** — Use the icons to move to the next or previous day.
9. **Time** — The horizontal axis of the graph indicates time, in accordance with the time format specified in the **Units Set-up** options.
10. **Current speed** — The vertical axis of the graph indicates speed, in accordance with the speed preferences specified in the **Units Set-up** options

Note: The data provided in the current graphs is for information purposes only and should NOT be relied upon as a substitute for prudent navigation. Only official government charts and notices to mariners contain all the current information needed for safe navigation. Always maintain a permanent watch.

Displaying details of currents

From the chart application:

1. Select the  diamond-shaped current icon.
The chart context menu is displayed.
2. Select **Current Station**.
The graph for the selected station is displayed.

Tide information

Animated tide information

The electronic charts may allow animation of the tide information tide stations.

Animated tide information is available in the chart application wherever a diamond-shaped symbol with a "T" is displayed:

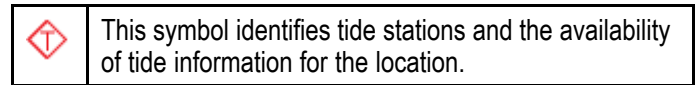

When you select a tide station symbol the chart context menu is displayed, which provides the **Animate** option.

When you select **Animate** the animate menu is displayed and the diamond-shaped symbols are replaced with dynamic tide bar which indicates the predicted tide height for the actual time and date:



- Tide height is indicated by a gauge. The gauge is comprised of 8 levels, which are set according to the absolute minimum / maximum values of that particular day.
- The color of the arrow on the tide gauges indicates changes in the tide height:
 - **Red:** increasing tide height.
 - **Blue:** decreasing tide height.

The animation can be viewed continuously or incrementally at a time interval that you specify. You can also set the date for the animation, and start or restart the animation at any point within a 24-hour period. If the system does not have a valid date and time the date used will be midday for the system default date.

Note: Not all electronic charts support the animated tides feature. Check the Navionics website: www.navionics.com to ensure the features are available on your chosen cartography level.

Viewing animated tide information

From the chart application:

1. Select diamond-shaped tide icon.
The chart context menu is displayed.
2. Select **Animate**.
The animate menu is displayed and the tide icon is replaced with a dynamic tide bar indicator.

Controlling animations

From the chart application, with the animate menu displayed:

1. To start or stop the animation, select **Animate:** to switch between Play and Pause.
2. To view the animation in steps, select **Step Back** or **Step Forward**.
3. To set the animation step interval, pause any playing animations, and then select **Set Time Interval**.

- To set the animation date, select **Set Date** and then using the on screen keyboard enter the required date.
- To set the animation date to the current date select **Today**.
- To set the animation date to 24 hours previous to the current date select **Previous Day**.
- To set the animation date to 24 hours ahead of the current date select **Next Day**.

- Select **Tide Station**.
The graph for the selected station is displayed.

Tide graphs

Tide graphs provide a graphical view of tidal activity.

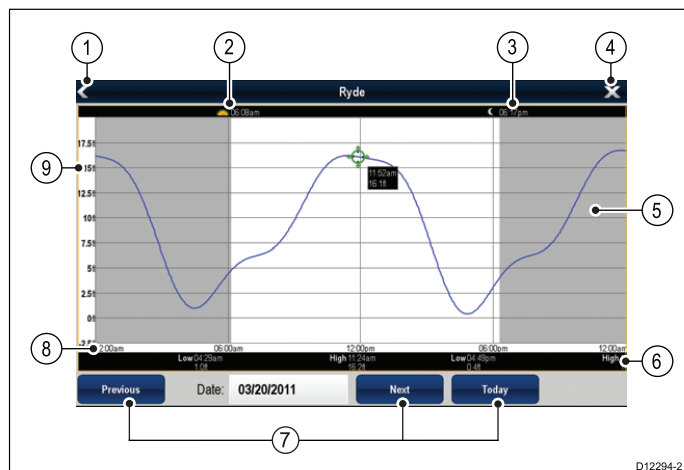

- Back** — return to the previous menu or view.
- Sunrise indicator** — indicates when the sun rises.
- Sunset indicator** — indicates when the sun sets.
- Exit** — closes the dialog.
- Nightfall indicator** — the greyed-out section of the graph indicates when nightfall occurs.
- Low / High Tide** — Indicates the time at which low or high tide occurs.
- Date navigation** — Use the icons to move to the next or previous day.
- Time** — The horizontal axis of the graph indicates time, in accordance with the time format specified in the System Settings.
- Depth** — The vertical axis of the graph indicates tidal water depth. The units for the depth measurement are based on those specified in the **Homescreen > Customize > Units Set-up > Depth Units** menu.

Note: The data provided in the tide graphs is for information purposes only and should NOT be relied upon as a substitute for prudent navigation. Only official government charts and notices to mariners contain all the current information needed for safe navigation. Always maintain a permanent watch.

Displaying details of tides

From the chart application:

- Select the  diamond-shaped tide icon.
The chart context menu is displayed.

18.15 Depth & Contour options

If supported by your cartography type, the following depth and contour settings are available.

Note: The menu items available are dependant upon your cartography type. The depth options are dependant upon the units of measure in use on your system.

Menu item	Cartography type	Description	Options
Show Soundings	LightHouse vector charts and Navionics	Determines the depth at which depth soundings are displayed.	<ul style="list-style-type: none"> • None • 0–30 ft / 0–10 m / 0–5 fa • 0–60 ft / 0–20 m / 0–10 fa • 0–180 ft / 0–50 m / 0–30 fa • 0–500 ft / 0–150 m / 0–83 fa • All (default)
Show Contours	Navionics	Determines whether contours are displayed.	<ul style="list-style-type: none"> • Off • 0–6 ft / 0–2 m / 0–1 fa • 0–18 ft / 0–5 m / 0–3 fa • 0–30 ft / 0–10 m / 0–5 fa • 0–50 ft / 0–15 m / 0–8 fa • 0–60 ft / 0–20 m / 0–10 fa • All (default)
Shallow Contour	LightHouse charts	Determines the depth at which the Shallow contour is displayed. The Shallow contour cannot be set to a value greater than the Safety or Deep contours.	<ul style="list-style-type: none"> • Off • 6 ft / 2 m / 1 fa • 12 ft / 3 m / 2 fa (default) • 18 ft / 5 m / 3 fa • 20 ft / 6 m / 4 fa • 30 ft / 10 m / 5 fa • 50 ft / 15 m / 8 fa • 60 ft / 20 m / 10 fa
Safety Contour	LightHouse charts	Determines the depth at which the Safety contour is displayed. The Safety contour cannot be set to a value less than the Shallow contour or higher than the Deep contour.	<ul style="list-style-type: none"> • Off • 6 ft / 2 m / 1 fa • 12 ft / 3 m / 2 fa • 18 ft / 5 m / 3 fa • 20 ft / 6 m / 4 fa • 30 ft / 10 m / 5 fa (default) • 50 ft / 15 m / 8 fa • 60 ft / 20 m / 10 fa
Deep Contour	LightHouse vector charts and Navionics	Determines the depth at which the Deep contour is displayed. The Deep contour cannot be set to a value less than the Shallow or Safety contours.	<ul style="list-style-type: none"> • Off • 6 ft / 2 m / 1 fa • 12 ft / 3 m / 2 fa • 18 ft / 5 m / 3 fa • 20 ft / 6 m / 4 fa • 30 ft / 10 m / 5 fa • 50 ft / 15 m / 8 fa (default) • 60 ft / 20 m / 10 fa

Menu item	Cartography type	Description	Options
Deep Water Color	Navionics	Determines the color of deep water.	<ul style="list-style-type: none"> • White (default) • Blue
Sonar Logs	Navionics	Allows logging of depth and position data to your Navionics chart card. This data will be sent to Navionics to improve the contour detail of Sonar Charts on your multifunction display. Refer to the Navionics website www.navionics.com for instructions on how to upload your sonar logs.	<ul style="list-style-type: none"> • On • Off

Depth soundings and contours

If supported by your cartography type, depth soundings and contours can be used in the Chart application to provide awareness of water depth.

When using vector based cartography you can adjust the depth at which the contours and soundings appear on-screen.

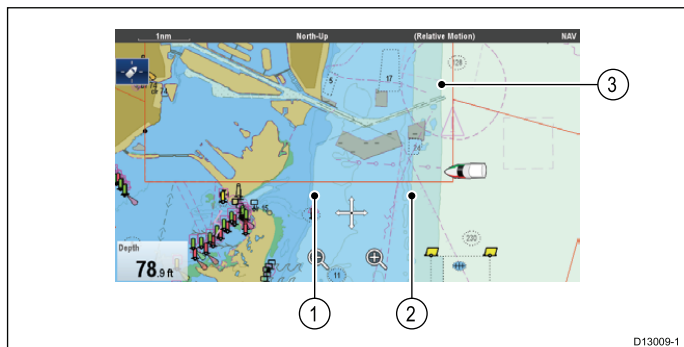

1. Shallow contour
2. Safety contour
3. Deep contour

The Depth & Contours menu can be accessed from:
Menu > Presentation > Depth & Contours.

18.16 My Data options

The My Data menu provides access to your user data.

The options are found in the **My Data** menu: **Menu > My Data**.

- **Waypoints** — View the waypoints group list.
- **Routes** — View the Routes list.
- **Tracks** — View the Tracks list.

Refer to [Chapter 17 Waypoints, Routes and Tracks](#) for further details.

18.17 Multiple chart synchronization

You can synchronize the heading, range, and position information across multiple chart views and networked displays.

When chart synchronization is enabled:

- It is indicated by “CHRT Sync” in the chart application title bar.
- Any changes made to the heading, range or position in any chart instance will be reflected in all other chart instances.

Note: When the 2D and 3D chart views are synchronized, the Motion Mode is always Relative Motion.

Synchronizing multiple chart instances

From the chart application:

1. Select **Menu**.
2. Select **Presentation**.
3. Select **Chart Sync**.
4. Select Chart from the list.
A tick is placed next to the selected option.
5. Repeat the steps above for each chart instance and if required on each networked multifunction display you want to sync the chart view.

Note: You cannot sync to another chart if radar sync is turned on.

18.18 Measuring distances and bearings

You can use the databar and context menu information you can use the measure function to measure distances in the chart application.

You can determine the distance and bearing:

- from your vessel to the position of the cursor;
- between two points on the chart.

Measuring from vessel position to cursor

From the chart application:

1. Select the location on screen that you want to measure the distance or bearing from your vessel.
The chart context menu will be displayed.
2. Select **Measure**.
The following will happen:
 - The measure menu will be displayed.
 - A line will be drawn from the cursor position to the center of the screen.
 - The cursor location will be moved at the center of the screen.
 - The bearing and distance will be displayed next to the new cursor location.
3. From the measure menu select **From** so that Ship is selected.
The ruler line is re-drawn from the cursor position to your vessel.
4. You can now adjust the ruler position by moving the cursor to the desired location.
5. If you want the ruler displayed after you have closed the measure menu, select **Ruler**: so that On is highlighted.
Selecting ruler will switch the ruler On and Off.
6. Select Back or Ok to close the measure menu leaving the current measurement on-screen.

Measuring from point to point

From the chart application:

1. Select the location on screen that you want to measure the distance or bearing from your vessel.
The chart context menu will be displayed.
2. Select **Measure**.
The following will happen:
 - The measure menu will be displayed.
 - A line will be drawn from the cursor position to the center of the screen.
 - The cursor location will be moved at the center of the screen.
 - The bearing and distance will be displayed next to the new cursor location.
3. Select **From** so that Cursor is selected.
Selecting measure from will switch between Ship and Cursor.

4. You can now adjust the end point by moving the cursor to the desired location.
5. You can also **Swap Direction** of the ruler so that the bearing becomes the bearing from end point to start point.
6. If you want the ruler displayed after you have closed the measure menu, select **Ruler** so that On is highlighted.
Selecting display ruler will switch the ruler On and Off.
7. Select **Back** or **Ok** to exit the measure menu leaving the current measurement on-screen.

Repositioning the ruler

You can reposition a ruler by following the steps below.

1. Select the current ruler.
The ruler context menu is displayed.
2. Select **Measure**.

You can now reposition the ruler as required.

Chapter 19: Fishfinder application

Chapter contents

- [19.1 Fishfinder overview and features on page 252](#)
- [19.2 Sonar technologies on page 254](#)
- [19.3 Raymarine sonar modules on page 257](#)
- [19.4 Multiple sonar module support on page 257](#)
- [19.5 Sonar crosstalk interference on page 259](#)
- [19.6 Custom channels on page 261](#)
- [19.7 The sonar image on page 262](#)
- [19.8 Depth Range on page 263](#)
- [19.9 **SideVision™** Range on page 264](#)
- [19.10 Fishfinder scrolling on page 264](#)
- [19.11 Fishfinder display modes on page 265](#)
- [19.12 **SideVision™** Views on page 267](#)
- [19.13 Presentation menu options on page 268](#)
- [19.14 Depth and distance on page 269](#)
- [19.15 Waypoints in the Fishfinder application on page 270](#)
- [19.16 Sensitivity settings on page 270](#)
- [19.17 Fishfinder alarms on page 275](#)
- [19.18 Frequency tuning on page 276](#)
- [19.19 Sounder set-up menu options on page 277](#)
- [19.20 Transducer set-up menu options on page 278](#)
- [19.21 Resetting the sonar on page 279](#)

19.1 Fishfinder overview and features

The Fishfinder application uses a sonar module and a suitable sonar transducer. The sonar module interprets signals from the transducer and builds up a detailed underwater view. Various sonar technologies are available, all of which work on the same basic principles.

The sonar transducer sends pulses of sound waves into the water and measures the time it takes for the sound waves to travel to the bottom and back. The returning echoes are affected by bottom structure and by any other objects in their path, for example reefs, wrecks, shoals or fish. The Sonar module interprets these signals and builds up a detailed underwater view which is displayed in the Fishfinder application.

The Fishfinder application uses colors and shading to indicate the strength of the returns. You can use this information to determine the bottom structure, the size of fish and other objects in the water, such as debris or air bubbles

Note:

- Some transducers include additional sensors to measure water temperature and/or speed.
- Not all Sonar modules can be used for a source of depth information.

Sonar technology

Traditional sonar technology	<ul style="list-style-type: none"> • Traditional sonar technology
CHIRP technology	<ul style="list-style-type: none"> • CHIRP technology
DownVision™ technology	<ul style="list-style-type: none"> • CHIRP DownVision™ overview
SideVision™ technology	<ul style="list-style-type: none"> • CHIRP SideVision™ overview

Fishfinder features

Supports multiple, active sonar modules.	<ul style="list-style-type: none"> • 19.4 Multiple sonar module support
Create custom channels.	<ul style="list-style-type: none"> • 19.6 Custom channels
Fishfinder application panes.	<ul style="list-style-type: none"> • Fishfinder application panes
Pausing and adjusting the speed of the scrolling image.	<ul style="list-style-type: none"> • 19.10 Fishfinder scrolling
Using waypoints to mark fishing spots or target locations.	<ul style="list-style-type: none"> • 19.15 Waypoints in the Fishfinder application
Determining target depths and distances.	<ul style="list-style-type: none"> • 19.14 Depth and distance
Setting Fishfinder alarms (fish, depth or water temperature).	<ul style="list-style-type: none"> • 19.17 Fishfinder alarms

Fishfinder display modes (Zoom, A-Scope or Bottom Lock).	<ul style="list-style-type: none"> • 19.11 Fishfinder display modes
Depth range controls (manual or automatic)	<ul style="list-style-type: none"> • 19.8 Depth Range
Distance range controls	<ul style="list-style-type: none"> • 19.9 SideVision™ Range
Sensitivity Settings to help optimize and simplify the displayed image.	<ul style="list-style-type: none"> • 19.16 Sensitivity settings

Fishfinder screen

The Fishfinder application displays a scrolling image across the screen of the water under your vessel. Each Fishfinder application pane can be independently configured to show a different sonar module / frequency.

Example CHIRP screen

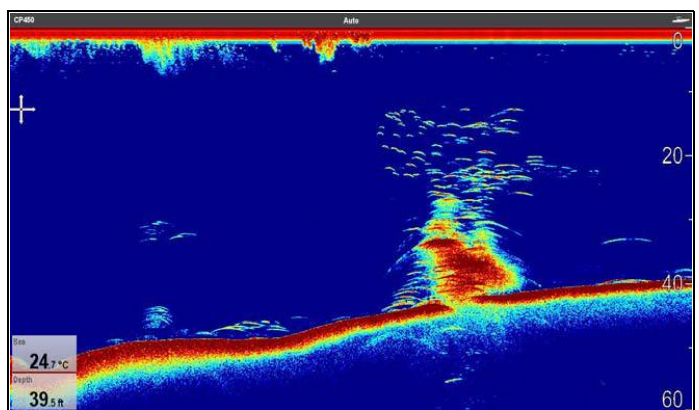

Example DownVision™ screen



Example SideVision™ screen

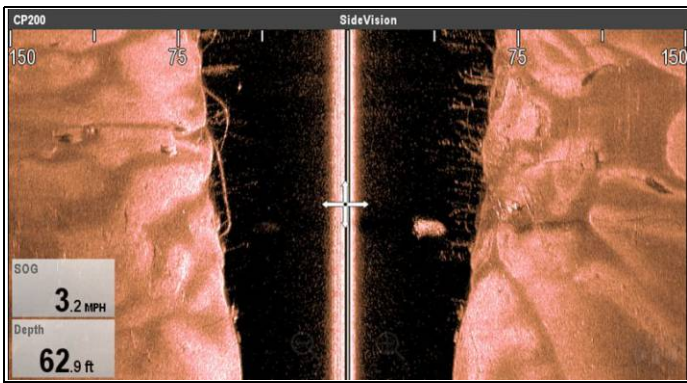

The Fishfinder window includes the following features:

- The bottom together with any bottom structure such as reefs and shipwrecks etc.
- Target images indicating fish.
- A status bar indicating the current sonar module and channel in use.
- Bottom depth.
- * On-Screen controls.

Note: * On-screen controls are only available on multifunction displays with a touchscreen and are dependent on the sonar module and channel that is being displayed.

Fishfinder application panes

All panes showing an instance of the Fishfinder application is independent and any changes made to the Channel selection or Display mode are automatically saved against that pane of the application.

Multiple pages can be set up on the Homescreen which can be used to display different combinations of Channel and Display mode.



Fishfinder context menu

The Fishfinder application context menu displays data and shortcuts to menu items.

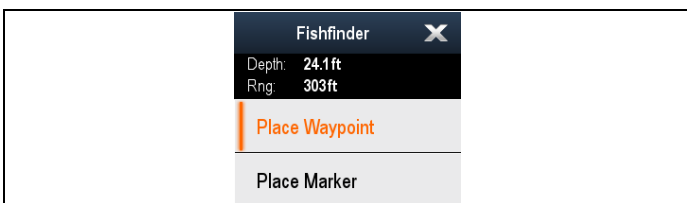

The context menu provides the data for the position of the cursor:

Fishfinder application

- Depth
- Range

The context menu also provide the following menu items:

- **Place Waypoint**
- * **Place Marker**
- * **Move Marker** (only available when a marker has been placed.)
- * **Erase Marker** (only available when a marker has been placed.)

Note: * Not available on **SideVision™**.

Accessing the context menu

You can access the context menu by following the steps below.

1. Non-touchscreen and HybridTouch displays:
 - i. Selecting a location, object or target on-screen and pressing the **Ok** button.
2. HybridTouch and Touch only displays:
 - i. Selecting an object or target on-screen.
 - ii. Selecting and holding on a location on-screen.

19.2 Sonar technologies

Traditional sonar technology

Traditional sonar uses a single carrier frequency or carrier wave for the sonar ping. The sonar works by measuring the time it takes the ping echo to return to the transducer to determine target depth.

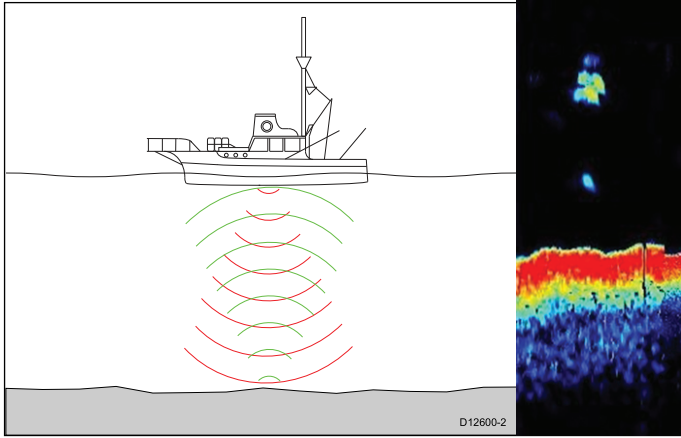

CHIRP technology

CHIRP sonars use a swept frequency 'CHIRP' signal which can distinguish between multiple close targets, this enables the sonar to display multiple targets instead of large combined targets that you would see when using traditional non-CHIRP sonar.

Benefits of CHIRP include improvements to target resolution, bottom detection even through bait balls and thermoclines and detection sensitivity.

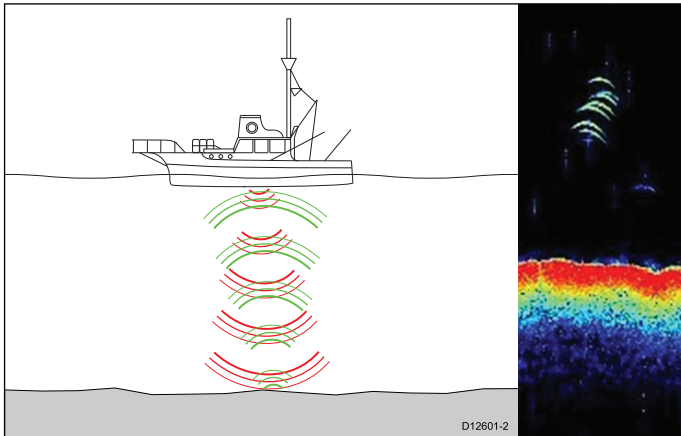

CHIRP Sonar overview

CHIRP sonar produces a conical shaped beam, the coverage of the conical beam is the water column directly beneath the vessel

Conical beam

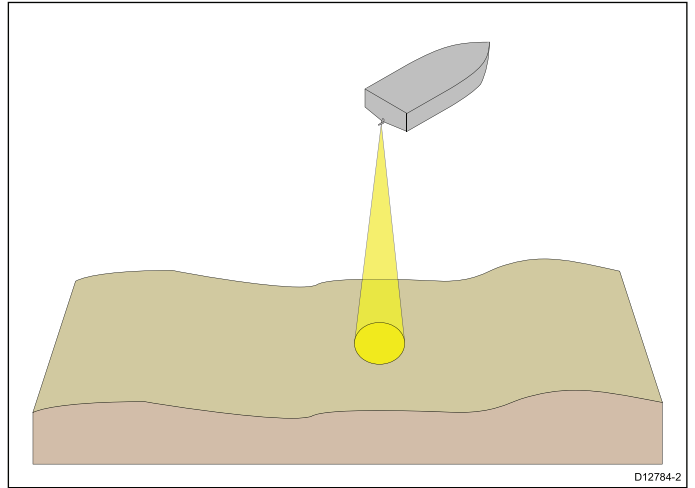

Sonar is effective at a range of speeds. In deeper waters the CHIRP bandwidth is automatically optimized to improve bottom lock and the detection of moving objects (e.g. fish) in the wider water column.

CHIRP sonar screen example

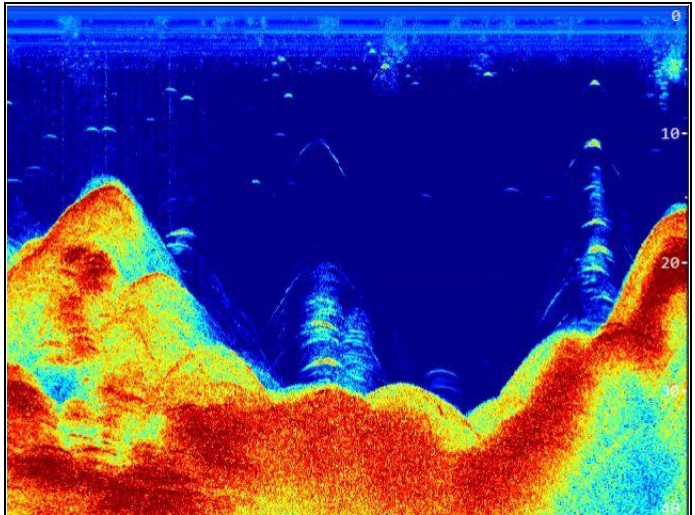

CHIRP DownVision™ overview

DownVision™ produces a wide-angle side-to-side beam and a thin fore-to-aft beam. The coverage of the DownVision™ beam is a water column directly beneath and to the sides of the vessel.

DownVision™ beam

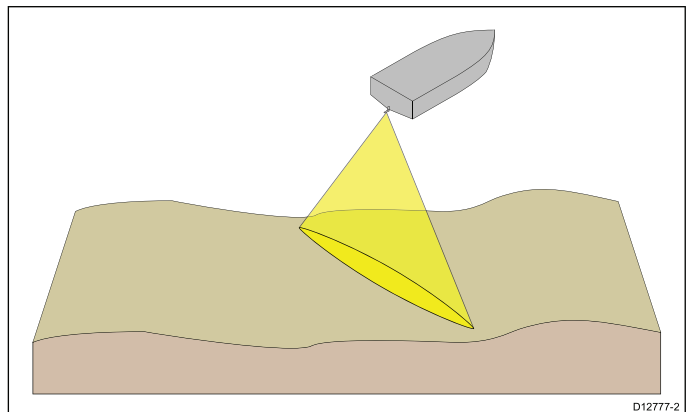

DownVision™ is effective at lower vessel speeds. In deeper waters the CHIRP bandwidth is automatically optimized to improve bottom lock and the detection of moving objects (e.g. fish) in the wider water column.

The wide, thin beam produces clear target returns. The use of CHIRP processing and a higher operating frequency provide a more detailed image, making it easier to identify bottom structures around which fish may reside.

CHIRP DownVision™ screen example

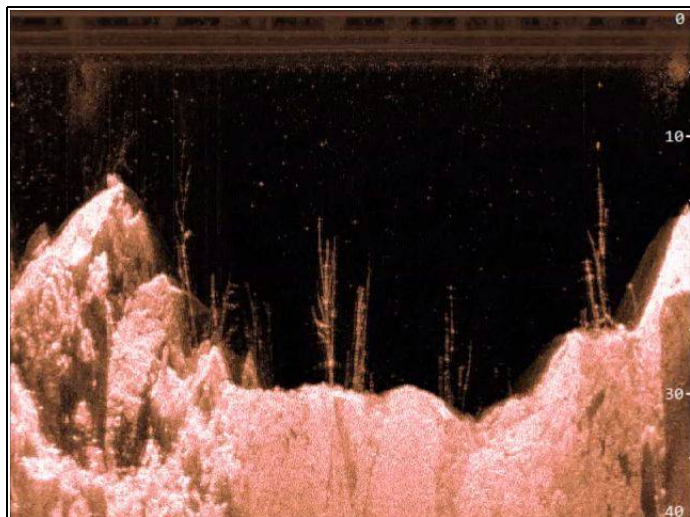

CHIRP SideVision™ overview

SideVision™ interprets signals from a pair of side-looking transducers and builds up a detailed underwater view as your vessel moves forward. The transducers send pulses of sound waves into the water on each side of your vessel, and record the sound waves that reflect off the bottom, and off objects on the bottom or suspended in the water column. The received echoes are affected by the bottom material (for example mud, gravel or rock), and by any other objects in their path (for example cables on the sea floor, bridge piers, wrecks, shoals or fish).

SideVision™ produces two wide-angle side-to-side beams, each with a thin fore-to-aft beam. The coverage of the **SideVision™** beams is a swath on each side of the vessel.

SideVision beams

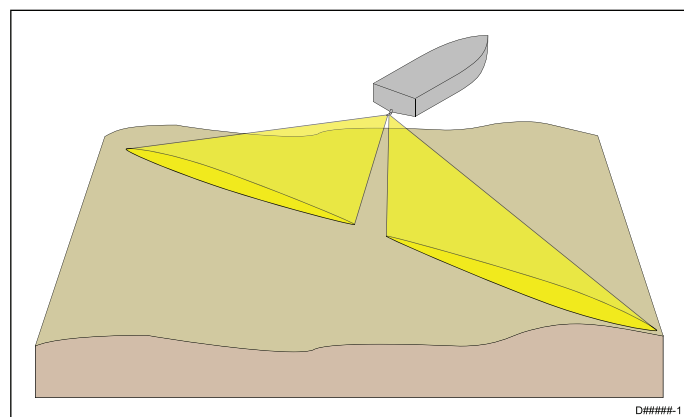

SideVision™ is effective at lower vessel speeds. The wide, thin beams produce clear target returns. As your vessel moves forward, subsequent returns build up to provide an image of the sea floor on each side of your vessel.

The use of CHIRP processing and a high operating frequency provide a detailed image, making it easier to identify bottom structures around which fish may reside. The narrow angle the beams make with the bottom at longer ranges can reveal the shadows of structures that protrude from the bottom.

CHIRP SideVision™ screen example



Note: The “Depth” figure shown in the illustration above assumes that you have a device in your system that provides depth data. Please be aware that not all transducers and / or sonar modules support depth sensing. For more information, refer to the latest specifications and documentation available for your particular products on the Raymarine website (www.raymarine.com).

Interpreting SideVision™ images

The following illustration shows how **SideVision™** images on your multifunction display are related to the water column and sea floor to the sides of your vessel.

Interpreting SideVision images

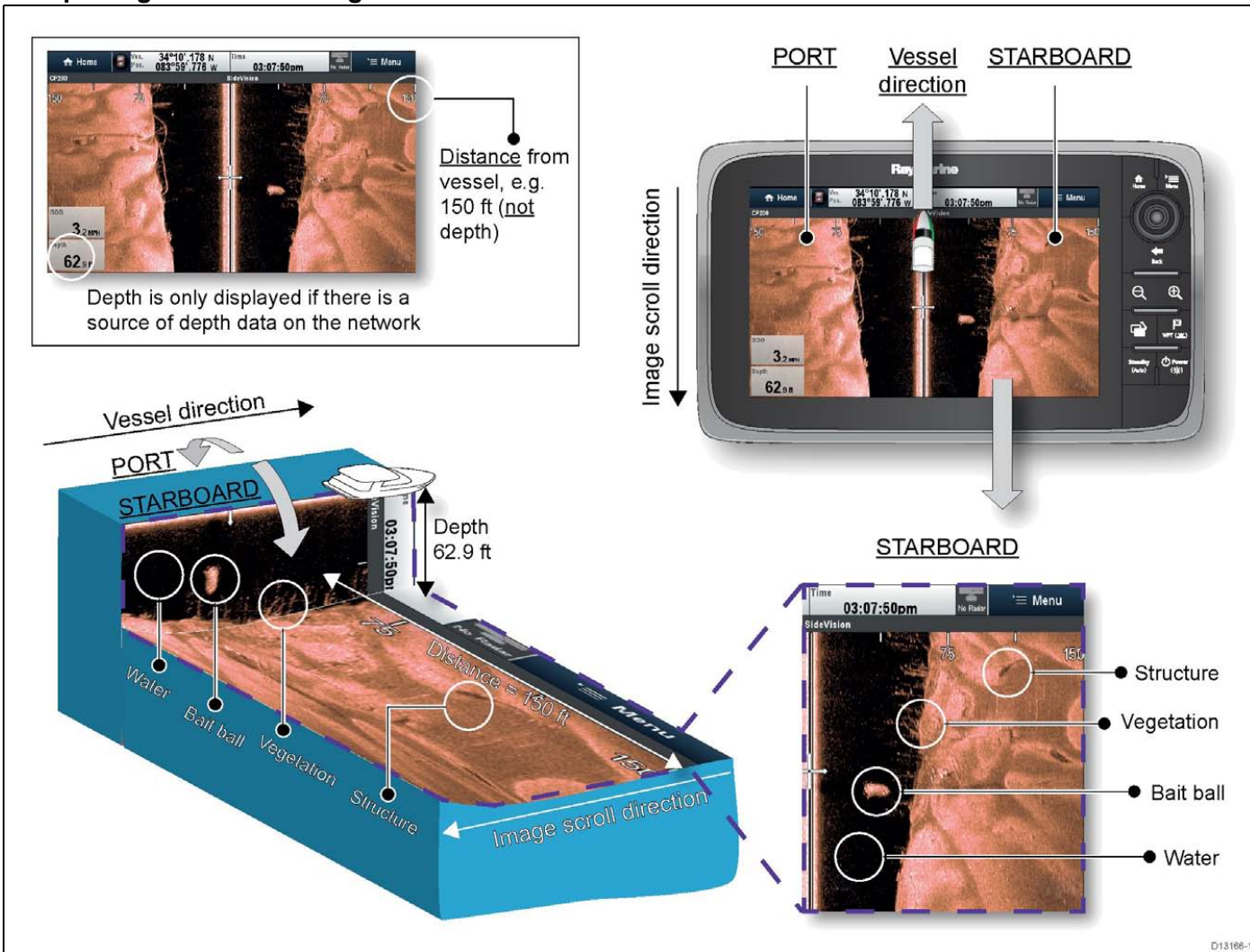

SideVision™ images are constructed line-by-line, similar to the way a television picture is composed of many horizontal lines. Each successive ping from the **SideVision™** transducer adds a new line of image data to the top of your display. Each new line shows sonar returns from both the port and starboard sides of your vessel.

As new lines are added with each successive ping, older data gradually scrolls down the display, building up a detailed image of the water column and sea floor to the sides of your vessel. If your vessel maintains the same bearing and speed for a period of time, you can interpret the image as a plan of the sea floor along your vessel's course.

The illustration also identifies examples of features that may be visible in **SideVision™** images:

- **Water:** close to your vessel, the **SideVision™** sonar beams may not interact with any solid objects in the water column until they hit the sea floor. The water column close to your vessel is displayed as a dark band in the image. The abrupt change to a lighter section in the image indicates where the sea floor is first detected with each ping.
- **Bait ball:** objects in the water column close to your vessel may be detected before the **SideVision™** beams hit the sea floor. In this example, a bait ball

is shown within the water column, at a distance of approximately 30 feet from the vessel.

- **Vegetation:** objects in contact with the sea floor that are close to your vessel may be clearly visible in the image at the point where the **SideVision™** beams hit the sea floor. In this example, the shapes in the image indicate vegetation attached to the sea floor.
- **Structure:** the lighter regions of the **SideVision™** image represent the sea floor. It may be possible to detect differences in the bottom material (for example, where an area of mud meets an area of gravel) as well as solid structures such as pipelines and piers. Larger solid structures, and sea floor relief, may reveal an area of shadow directed away from your vessel.

Note: Unlike **DownVision™**, **SideVision™** does not provide direct depth readings. The scale shown across the top of the image indicates the **distance** of features from your vessel.

19.3 Raymarine sonar modules

You can find details on Raymarine's sonar modules below.

The depth shown below for DownVision™ and the range for SideVision™ sonar modules are typical achievable depths / ranges, depending on the connected transducer in optimum water conditions. The depths shown for Traditional and CHIRP sonar modules are the maximum depths achievable depending on connected transducer in optimum water conditions.

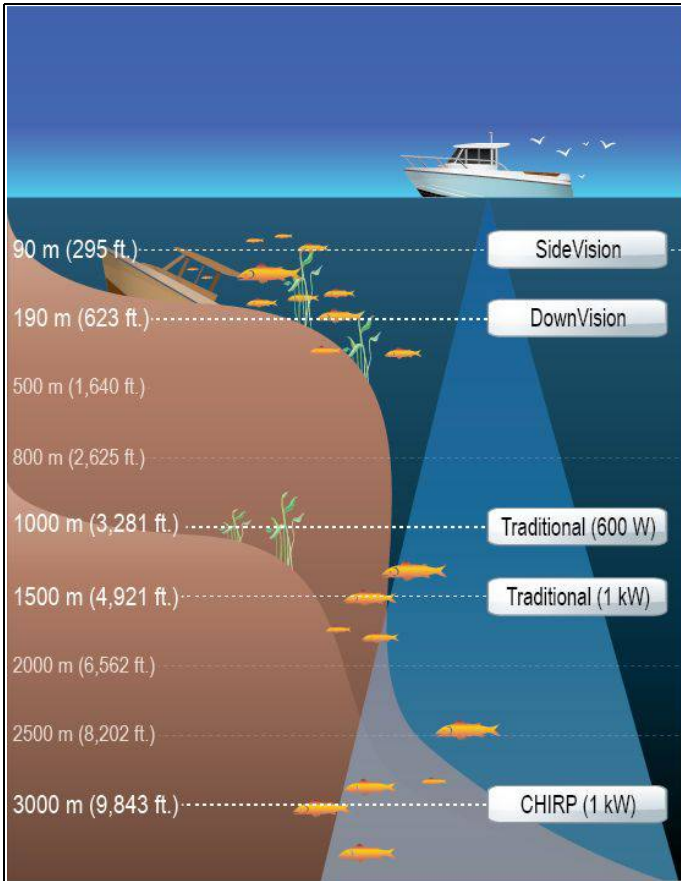

Sonar module	Technology / Description
CP100	DownVision™ external
CP200	SideVision™ external
CP300	Traditional external
CP450C	CHIRP external
Dragonfly	DownVision™ internal
a68 / a78 / a98 / a128	DownVision™ internal
a67 / a77 / a97 / a127	Traditional internal
c97 / c127	Traditional internal
e7D / e97 / e127	Traditional internal
DSM30 / DSM300	Legacy external

Note: SideVision™ cannot be used as a source of depth data.

19.4 Multiple sonar module support

Your multifunction display supports multiple active sonar modules on the same network.

You can select which sonar channel you want to be displayed on-screen. Only 1 channel can be displayed at a time in a single Fishfinder application pane. Multiple channels can be displayed at the same time using custom splitscreen pages. Alternatively multiple custom pages could be set up to suit individual requirements.

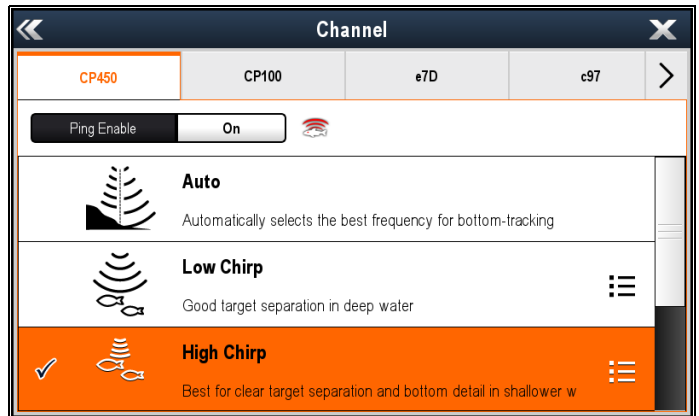

Channel	Description	Sonar module
Auto	Automatically selects the best frequency for bottom tracking	<ul style="list-style-type: none"> CP300 CP450C Sonar variant MFDs
50 kHz / 83 kHz	Good for deeper waters and for a wide sonar beam	<ul style="list-style-type: none"> CP300 CP450C Sonar variant MFDs
100 kHz	Good detail at most depths, with moderately wide sonar beam	<ul style="list-style-type: none"> CP450C
160 kHz	Gives good detail in shallow waters	<ul style="list-style-type: none"> CP450C
200 kHz	Gives the best detail in shallow waters	<ul style="list-style-type: none"> CP300 Sonar variant MFDs
Low CHIRP	Good target separation in deep water	<ul style="list-style-type: none"> CP450C
Medium CHIRP	Good all round performance, with great target separation	<ul style="list-style-type: none"> CP450C
High CHIRP	Best for clear target separation in shallow waters and bottom detail	<ul style="list-style-type: none"> CP450C
DownVision™	Gives photo like images of bottom structure	<ul style="list-style-type: none"> CP100 DownVision™ variant MFDs

Channel	Description	Sonar module
SideVision™	Gives a clear view of fish and structure either side of your vessel.	• CP200
Sonar (200 kHz CHIRP)	Targets bait and predator fish with wide sonar beam	• CP100 • DownVision™ variant MFDs

Note:

1. The channels available are dependent on the sonar module and its connected transducer.
2. **DownVision™** sonar modules include both a **DownVision™** channel and a traditional sonar channel.
3. **SideVision™** sonar modules include 1 **SideVision™** channel, the view icons can be used to switch between left and right views.

Important software requirements for multiple sonar systems

If your system includes more than one source of sonar data you must ensure that any CP300 or CP450C sonar modules are running software version **v4.04** or later.

This applies to systems which include:

- Any number of MFD(s) with an internal sonar module plus a CP300 and / or CP450C sonar module; or
- No MFD(s) with an internal sonar module, but more than one CP300 or CP450C sonar module.

This does NOT apply to any systems that do NOT include a CP300 or CP450C sonar module.

Note: For software downloads and instructions on how to update the software for your product(s), visit www.raymarine.com/software.

Selecting the sonar channel

To select the channel you want to display follow the steps below.

From the Fishfinder application:

1. Select **Menu**.
2. Select **Channel**.
The Channel selection page is displayed.
3. Select the tab for the sonar module you want to use.
A list of available channels for the selected sonar module is displayed.
4. Select a channel from the list.

The Channel selection page will close and the Fishfinder application will now show the selected channel.

Displaying multiple sonar channels

Up to 4 sonar channels can be viewed at the same time by creating a custom splitscreen page that includes multiple Fishfinder application instances.

Important: Your ping rate may be reduced if you display different channels from the same sonar module at the same time.

1. Create a new splitscreen page using multiple instances of the Fishfinder application.

Refer to the [Changing an existing page on the homescreen](#) section to find out how to create a page.

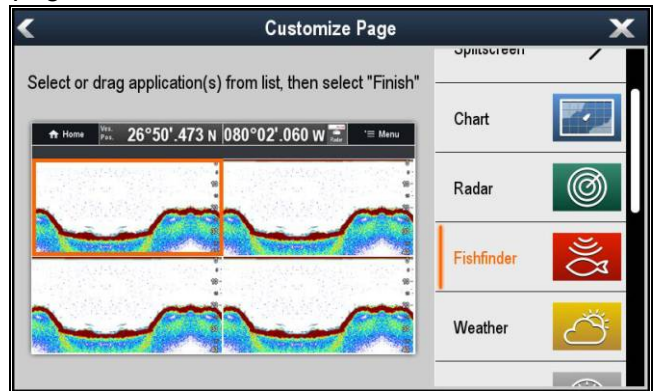

2. Open the newly created page.

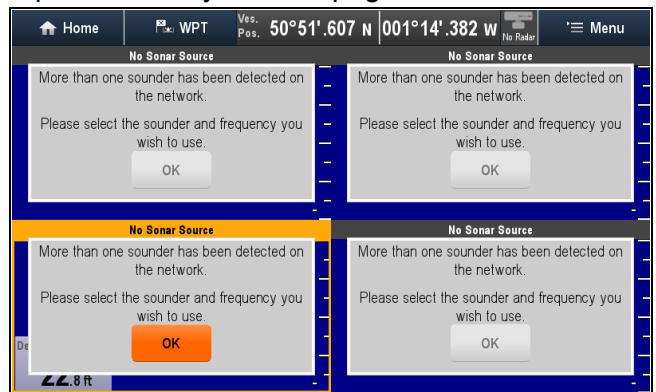

3. Select the **Ok** button in one of the Fishfinder panes.
4. Select to channel that you want to view in the selected pane.

Refer to the [Selecting the sonar channel](#) section for details on selecting a sonar channel.

5. Repeat steps 3 and 4 for each pane on the splitscreen page.

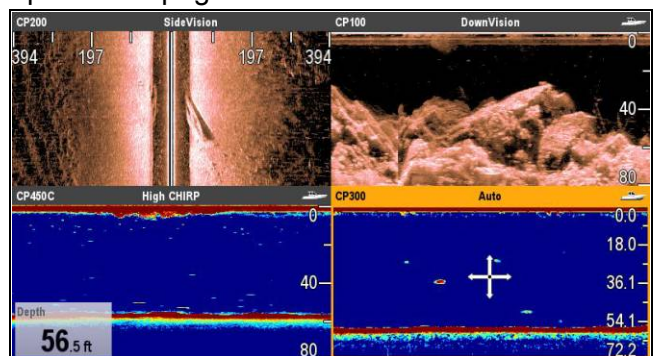

Depth data source

Where multiple sources of depth data exist on a system and the depth Data Source is set to Auto the system will automatically select the optimum source for depth data.

The system will set the data source for depth according to the priority table below:

1 st	CP450C	SeaTalk ^{hs}
2 nd	CP300	SeaTalk ^{hs}
3 rd	DSM300	SeaTalk ^{hs}
4 th	DSM30	SeaTalk ^{hs}
5 th	Traditional sonar variant multifunction displays	SeaTalk ^{hs} / internal
6 th	DownVision™ variant multifunction display	SeaTalk ^{hs} / internal
7 th	CP100	SeaTalk ^{hs}
8 th	Instrument / multifunction display	SeaTalk ^{ng}
9 th	Instrument	SeaTalk
10 th	Instrument / multifunction display	NMEA 0183

If multiple sonar modules of the same type are present on a SeaTalk^{hs} network then the unit with the highest serial number will be selected as the preferred data source. For SeaTalk^{ng} and NMEA 0183 networks the unit with the highest CAN address is selected.

If the preferred depth data source becomes unavailable then the system will automatically select the next highest priority data source.

Refer to the [Data Source menu](#) section for details on selecting preferred data sources.

Important: A depth offset must be set for all installed transducers to ensure consistent and accurate data is shown. Refer to the [Depth Offset](#) section for details.

Note: SideVision™ cannot be used as a source for depth data.

19.5 Sonar crosstalk interference

There are 2 types of potential sonar crosstalk interference in a Raymarine sonar system:

1. **SideVision** sonar crosstalk interference
2. Multiple sonar crosstalk interference

The types of crosstalk interference that you may experience in your system depend on the combination and type of sonar equipment installed, and the way in which the equipment has been installed.

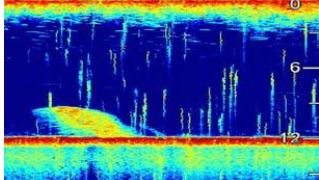
SideVision sonar crosstalk interference	Multiple sonar crosstalk interference
	
<p>Due to the high sensitivity of SideVision transducers, you may experience some minor crosstalk interference between the left and right receiving channels in areas of strong target returns. Examples of strong target returns include solid objects such as underwater bridge structure. This interference shows up in the Fishfinder application as subtle reflections from the right sonar image displayed in the left sonar image, or vice versa.</p>	<p>When using multiple sonar modules and transducers operating in overlapping frequency ranges, you may experience some crosstalk interference between the ranges. This interference is displayed in the Fishfinder application as vertical “rain drops” throughout the water column. These vertical “rain drops” indicate that 2 sonar modules are operating in close frequency proximity to one another.</p>

SideVision sonar crosstalk interference

Crosstalk interference is expected behavior in a high sensitivity device such as a **SideVision** transducer, and is not indicative of a fault with your transducer or sonar module.

Reducing multiple sonar crosstalk interference

Crosstalk interference in systems with multiple sonar modules and transducers is the result of a number of factors, including installation, operation, and environment.

- **Choose an equipment combination that minimizes overlapping frequencies.** Wherever possible, choose to use sonar modules and transducers that operate in different frequency ranges (“Channels”), for example CP100 and CP300 sonar modules and CPT-100 and B744V transducers. This will help to ensure that each component is operating in a distinct relative frequency range – for example, a “high” frequency range for the CP100 and a “low” frequency range for the CP300.
- **Only use the sonar channels that you really need.** Although it is possible to run multiple sonar

modules simultaneously in a Raymarine system, it may not always be necessary to do so. If you are in a scenario that requires only one sonar module to be active at a time, disable any other sonar modules by changing the Fishfinder application pane to a single one which only displays the output from one sonar module. Alternatively, disable the ping for any unused sonar modules by selecting **MENU > Channel > Ping > OFF** in the Fishfinder application.

- **Identify the sonar module and transducer that is causing the interference.** To do this, disable the ping or remove the power for one of the sonar modules in your system. If the interference in the Fishfinder application disappears immediately, you now know which device is causing the interference. If the interference doesn't disappear, repeat the exercise again with the other sonar module(s) in your system, one at a time. Once you know which device is causing the interference, proceed with the following methods to reduce the interference from the relevant device.
- **Adjust the Interference Rejection Filter.** The default setting for all Raymarine MFDs is "Auto". Changing this setting to "High" might help to reduce interference (**MENU > Setup > Sounder Setup > Interference Rejection**). Note that the Interference Rejection Filter setting is not available for all sonar modules.
- **Decrease the power output of the interfering transducer.** Adjusting the "Power Mode" in the Sensitivity Settings in the MFD's Fishfinder application can help to minimize the presence of crosstalk interference (**MENU > Sensitivity Settings > Power Mode**). Note that the Power Mode setting is not available for all transducers.
- **Ensure that you have a common RF ground point for all electrical equipment on your vessel.** On vessels without an RF ground system, ensure all product drain wires (where available) are connected directly to the negative battery terminal. Ineffective RF grounding can cause electrical interference which may in turn result in sonar crosstalk interference.
- **Increase the physical distance between your sonar modules.** Electrical interference may be occurring between a cable on one sonar module, and a cable on a different sonar module. Ensure that your sonar modules are physically located as far away from each other as possible.
- **Increase the physical distance between your sonar transducers.** Electrical and / or acoustic interference may be occurring between the different transducers in your system. Ensure that your transducers are physically located as far away from each other as possible.

Note: Due to physical size and other constraints that vary from vessel to vessel, it may not be possible to completely eliminate crosstalk interference from your system. However, this will not impede your ability to benefit from the full capabilities of your sonar system. Being able to easily identify the way in which interference is displayed in the Fishfinder application can sometimes be the best and easiest route to dealing with it.

Note: Given the effort and potential difficulties involved in relocating sonar equipment, it should only be considered as a last resort when you judge the interference to be a significant problem which cannot be resolved using the methods described above.

19.6 Custom channels

When connected to an **External Traditional** sonar module such as the CP300 or an **External CHIRP** sonar module such as the CP450C, custom channels can be created from the sonar module's default channels; excluding Auto channels. This enables some settings to be customized and saved as a separate channel. These channels can then be assigned to individual Fishfinder application panes. Up to 10 custom channels can be created for each compatible sonar module.

When changed the following settings are saved to the channel that is currently displayed:

- Sensitivity settings
- Range settings
- Frequency tuning — Only 2 frequency settings can be saved per transducer / sonar module combination.

Note: Performing a Sonar Reset will erase all custom channels for the current sonar module.

Creating a custom channel

To create a custom channel follow the steps below.

From the Fishfinder application menu:

1. Select **Channel**.
The Channel selection page is displayed.
2. Select the tab for the sonar module you want to create a custom channel for.
3. Select the **Channel options** icon located next to the channel that you want to use, or
4. using non-touch controls, select the channel and then press and hold the **Ok** button until the options screen is displayed.
5. Select **Copy Channel**.
The on-screen keyboard is displayed.
6. Enter the name you want to assign to your new channel.
7. Select **SAVE**.

The new channel is now available in the channel list for the relevant sonar module.

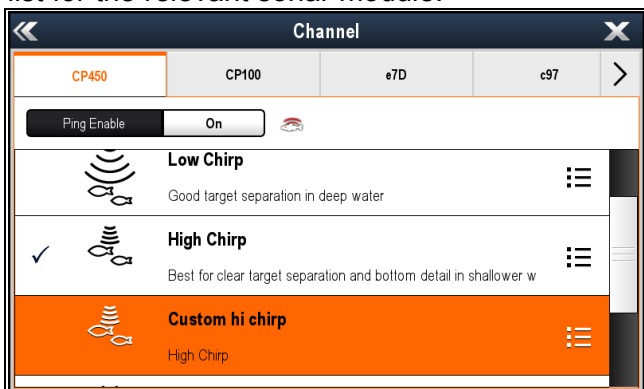

8. Select the new channel to display it in the Fishfinder application pane.
Changes made to the Sensitivity, Range or Frequency tuning settings are automatically saved to the channel displayed.

You can now assign the new channel to a Fishfinder application pane.

Renaming custom channels

With the Channel selection page displayed:

1. Select the tab for the sonar module that contains the channel you want to rename.
2. Select the **Channel options** icon next to the custom channel.

The custom channel options page is displayed

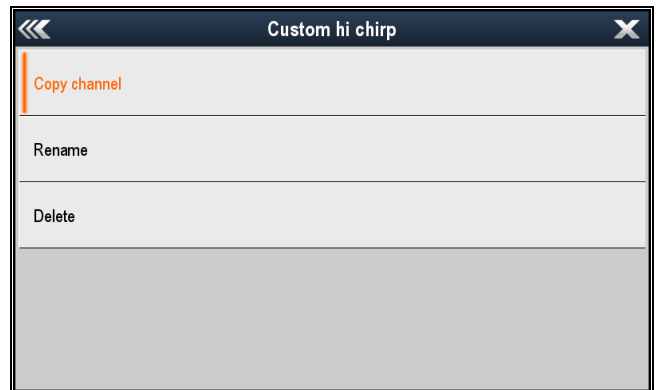

3. Select **Rename**.
The on-screen keyboard is displayed.
4. Enter the new name for the channel.
5. Select **SAVE**.

Deleting custom channels

With the Channel selection page displayed:

1. Select the tab for the sonar module that contains the channel you want to delete.
2. Select the **Channel options** icon next to the custom channel.
3. Select **Delete**.
A confirmation dialog is displayed.
4. Select **Yes**.

The custom channel has now been removed from your system.

19.7 The sonar image

Interpreting the bottom using sonar

It is important to understand how to correctly interpret the bottom structure represented on-screen.

The bottom usually produces a strong echo.

The following images show how different bottom conditions are represented on-screen:

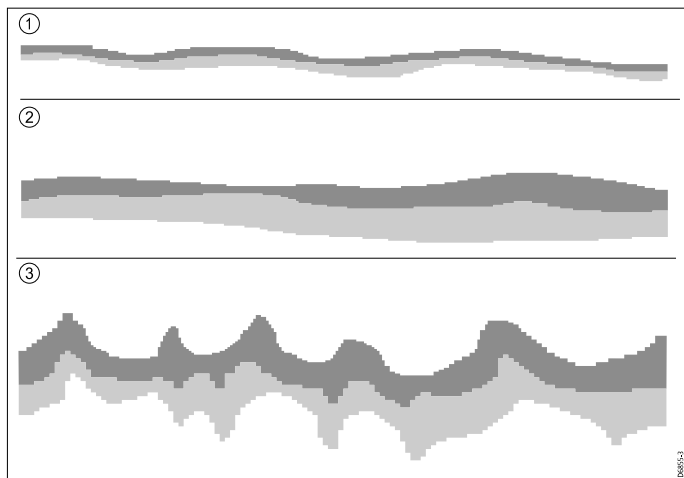

Item	Description
1	A hard bottom (sand) produces a thin line.
2	A soft bottom (mud or seaweed cover) produces a wide line.
3	A rocky or uneven bottom or a wreck produces an irregular image with peaks and troughs.

The dark layers indicate a good echo; the lighter areas indicate weaker echoes. This could mean that the upper layer is soft and therefore allowing sound waves to pass to the more solid layer below.

It is also possible that the sound waves are making two complete trips – hitting the bottom, bouncing off the vessel, then reflecting off the bottom again. This can happen if the water is shallow or the bottom is hard.

Factors influencing the sonar display

The quality and accuracy of the display can be influenced by a number of factors including vessel speed, depth, object size, background noise and transducer frequency.

Vessel speed

The shape of the target changes along with your speed. Slower speeds return flatter, more horizontal marks. Higher speeds cause the target to thicken and arch slightly, until at fast speeds the mark resembles a double vertical line.

Target depth

The closer the target to the surface, the larger the mark on screen.

Water depth

As water depth increases signal strength decreases, resulting in a lighter onscreen image of the bottom.

Size of the target

The larger the target, the larger the return on the fishfinder display. The size of a fish target is also dependent upon the size of the fish's swim bladder rather than its overall size. The swim bladder varies in size between different breeds of fish.

Clutter / Background noise

The fishfinder picture may be impaired by echoes received from floating or submerged debris, air bubbles or even the vessel's movement. This is known as 'Noise' or 'Clutter' and is controlled by the Sensitivity Settings. The system can automatically control some settings according to depth and water conditions. You can also adjust the settings manually if required.

Transducer frequency

The same target will appear differently when using different transducer frequencies. The lower the frequency the broader the mark.

Recovering lost bottom

If the seabed floor (bottom) is lost then follow the steps below to recover the bottom depth.

From the fishfinder application:

1. Ensure your vessel is in clear undisturbed water.
2. If range is set to Manual, adjust the range to the known, charted depth of your location. or
3. If range is set to Auto then switch the range to manual and adjust the range to the known, charted depth of your location.
4. Once bottom has been regained you can switch range mode back to Auto.

19.8 Depth Range

The Depth Range function enables you to define the range of depth that you see in the Fishfinder application. In Auto Range, the Fishfinder application automatically adjusts the range to ensure the water column and bottom are always displayed. In Manual Range, you can adjust the range displayed on-screen to suit your needs.

The table below shows examples of the Range function used with different sonar types.

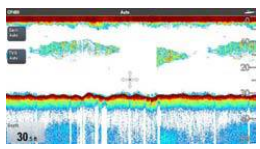
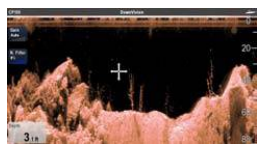
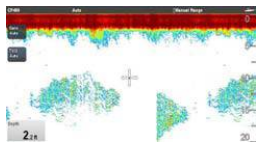
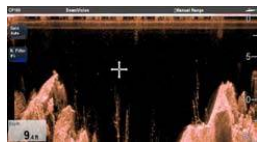
	Traditional and CHIRP channels	DownVision™ channel
Auto Range		
Manual Range		

Changing the depth range

You can choose from either:

- **Automatic** adjustment whereby the display automatically shows the shallowest required range.
- **Manual** adjustment of the depth range, up to the maximum depth allowed by the Fishfinder application.

From the Fishfinder application menu:



1. Select **Range**.
2. Select **Range** to switch between Auto and Man.
3. With manual mode selected you can now adjust the depth range shown on-screen.

Note: With the **Range** menu displayed you cannot use the **Rotary Control** to range in and out. To use the **Rotary control** to range in and out, first close the **Range** menu.

Range in and out

The method of ranging in and out of the Fishfinder application is dependent upon the multifunction display variant being used.

The table below shows the Range controls available for each display variant.

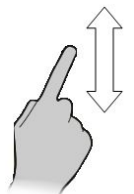
	Controls	Multifunction displays
	Rotary Control	<ul style="list-style-type: none"> • c Series • e Series • RMK-9 keypad
	Range in and Range out buttons	<ul style="list-style-type: none"> • c Series • e Series (excluding e7 and e7D) • RMK-9 keypad
	Slide the screen Up or Down	<ul style="list-style-type: none"> • a Series • e Series • gS Series

Range shift

The Range Shift function enables a specific area of the water column to be displayed on-screen.

In the below example the top 20 feet of the water column is not displayed

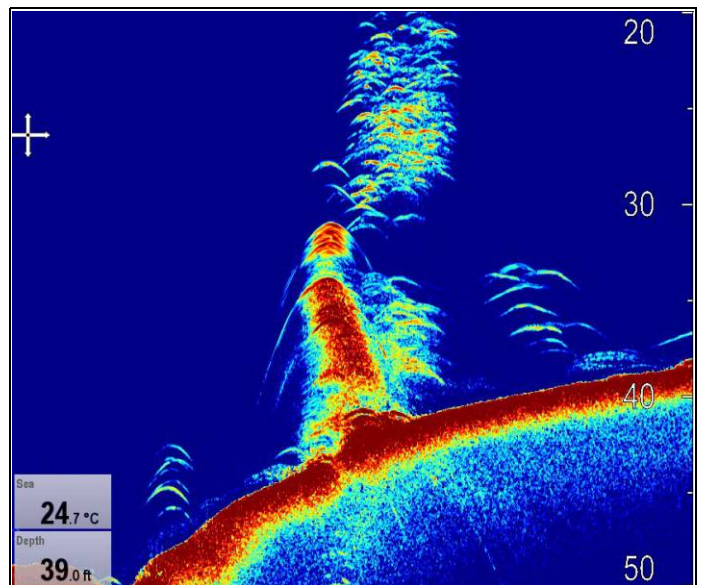

Using range shift

The default setting adjusts the display to keep the bottom in the lower half of the screen. Alternatively you can shift the image within the current range.

From the application menu, with **Range** set to Manual:

1. Select **Range**.
2. Select **Range Shift**.
The range shift dialog is displayed.
3. Adjust the setting to the required value.
You will see the range changing on the screen as you adjust the setting.
4. Select **Back** or press the **Ok** button to confirm the setting and close the range shift dialog.

19.9 SideVision™ Range

The **SideVision™** Range function enables you to define the distance to the left and right of the vessel that is displayed on-screen. The range displayed on-screen can be adjusted to suit your needs.

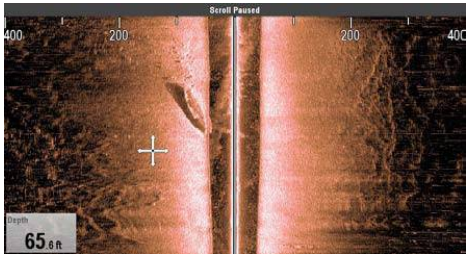
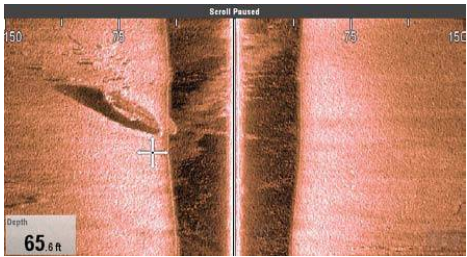

The table below shows examples of the **SideVision™** Range function.

	SideVision™ channel
Ranged Out	
Ranged In	

SideVision™ Range in and out

The method of ranging in and out of a Fishfinder application displaying **SideVision™** is shown below.

The table below shows the Range controls available for each display variant.

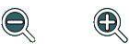
	Controls	Multifunction displays
	Rotary Control	<ul style="list-style-type: none"> • c Series • e Series • RMK-9 keypad
	Range in and Range out buttons	<ul style="list-style-type: none"> • c Series • e Series (excluding e7 and e7D) • RMK-9 keypad
	Range in and Range out on-screen icons	<ul style="list-style-type: none"> • a Series • e Series • gS Series

19.10 Fishfinder scrolling

The fishfinder image scrolls from right to left. You can pause the scrolling or adjust the scroll speed, to ease placing of waypoints or VRMs onscreen.

Scroll speed

You can adjust the speed at which the fishfinder image scrolls. A faster speed provides more detail which may be useful when you are looking for fish. If you select a slower speed the information remains on the display for longer.

Scroll pause

You can pause the display to see a 'snapshot' of the fishfinder image. When the image is paused scrolling stops but the depth indication continues to be updated.

Adjusting the scroll speed

The default scroll speed is 100%, the scroll speed can be adjusted following the steps below.

From the Fishfinder application menu:

1. Select **Presentation**.
2. Select **Scroll Speed**.
The Scroll speed numeric adjust control is displayed.
3. Adjust the scroll speed to the required setting.

Adjustment increments are as follows:

- 10% increments for values between 10% and 100%
 - 100% increments for values between 100% and 500%
4. Select **Back** or **Ok** to confirm and close the numeric adjust control.

Pausing the screen

The Fishfinder application can be paused.

From the Fishfinder application:

1. Select **Menu**.
2. Select **Scrolling** so that Pause is highlighted.
Selecting Scrolling again will resume the scrolling.

19.11 Fishfinder display modes

Selecting a display mode for the Fishfinder application

When using a Legacy, Traditional, **CHIRP** or **DownVision™** you can select which display mode you want to use.

From the Fishfinder application:

1. Select **Menu**.
2. Select **Display Mode**.
3. Select **Select Mode**.
4. Select the required display mode:
 - None
 - Zoom
 - * A-Scope
 - * Bottom Lock

Note: * Not available on the **DownVision™** channel of a **DownVision™** sonar module.

Note: Display modes are not applicable to **SideVision™**.

Fishfinder zoom mode

The zoom display mode magnifies a region of the fishfinder screen to display more detail.

This zoom option enables you to:

- Replace the standard fishfinder image with the zoomed image, or display the zoomed image alongside the standard fishfinder image.
- Set the zoom factor to a predefined level, or adjust it manually.
- Reposition the zoomed portion of the image to a different point in the display.

When the range increases, the area shown in the zoom window also increases.

Zoom split

With the zoom display mode you can split the screen and display the zoomed image alongside the standard fishfinder image (ZOOM SPLIT). The zoomed section is indicated on the standard fishfinder screen by a zoom box.

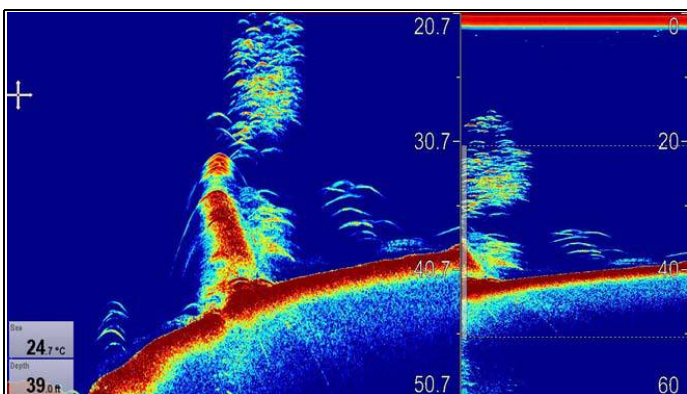

Selecting split screen in zoom mode

From the fishfinder application, with the zoom display mode selected:

Fishfinder application

1. Select **Menu**.
2. Select **Display Mode**.
3. Select **Zoom** so that Split is highlighted.
Selecting Zoom will switch between Split and Full.

Adjusting the fishfinder zoom factor

When the display mode is set to Zoom, you can select a zoom factor or adjust it manually.

From the Fishfinder application, with the display mode set to Zoom.

1. Select **Menu**.
2. Select **Display Mode**.
3. Select **Zoom Factor**.
4. Select a preset Zoom Factor (**x2**, **x3**, **x4**) or select **Manual**
Once selection is made you will be returned to the Display Mode menu.
5. If Manual is chosen select **Manual Zoom**
The manual zoom factor numeric adjust dialog is displayed.
6. Adjust the setting to the required value.
7. Select **Back** or use the **Ok** button to confirm the setting.

Adjusting the position of the fishfinder zoomed area

When the Zoom display mode is selected, the system automatically selects a zoom position so that the bottom details are always shown in the lower half of the screen. If required, you can reposition the portion of the image to be zoomed so that an alternative area is displayed.

From the Fishfinder application, with Zoom display mode selected:

1. Select **Menu**.
2. Select **Display Mode**.
3. Select **Zoom Position** so that Man is selected.
Selecting the zoom position will switch between Man and Auto.
4. Select **Man Zoom Pos**.
The Zoom position numeric adjust control is displayed.
5. Adjust the setting to the required value.
6. Select **Back** or **Ok** to close the menu.

Fishfinder A-Scope mode

The A-Scope mode enables you to view a live (rather than historical) image of the seabed and fish directly below your vessel.

The standard fishfinder display shows a historical record of fishfinder echoes. If required, you can display a live image of the bottom structure and the fish directly below the transducer by using the A-Scope feature. The width of the bottom covered by the A-Scope is indicated at the bottom of the window. A-Scope provides a more precise and easier to interpret indication of the target strength.

There are three A-Scope modes:

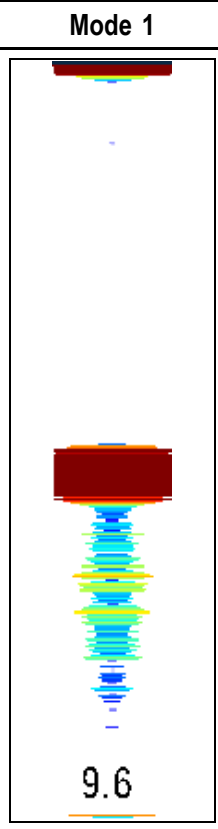
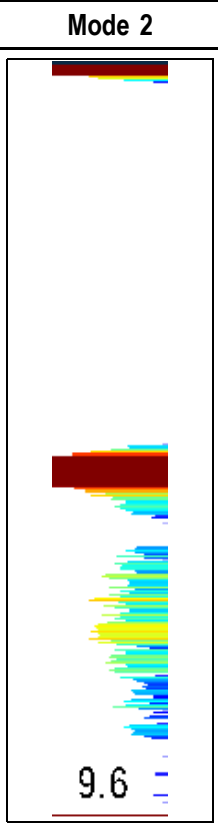
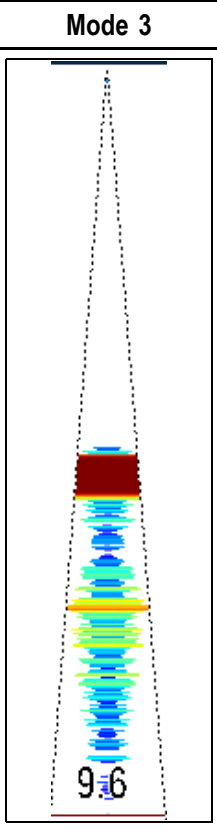
Mode 1	Mode 2	Mode 3
		
The A-scope image is centred in the window.	The left-hand side of the Mode 1 image is expanded to give a more detailed view.	The A-scope image angles outward as signal width increases with depth.

The numbers displayed at the bottom when in A-Scope mode indicate the approximate diameter (in selected depth units) of the conical beam's coverage of the bottom.

Selecting A-Scope mode

From the fishfinder application, with the A-Scope display mode selected:

1. Select **Menu**.
2. Select **Display Mode**.
3. Select **Select Mode**:
4. Select **A-Scope**.
5. Select **A-Scope**: to display the list of A-Scope modes.
6. Select the required mode.

Bottom Lock

The Bottom Lock display mode applies a filter which flattens the image of the bottom and makes any objects on or just above it easier to see. This feature is particularly useful for finding fish that feed close to the bottom.

Adjusting the range of the bottom lock image allows you to view more bottom details. You can also reposition the image on the screen to anywhere between the bottom of the window (0%) and the middle of the window (50%) using the Bottom Shift control.

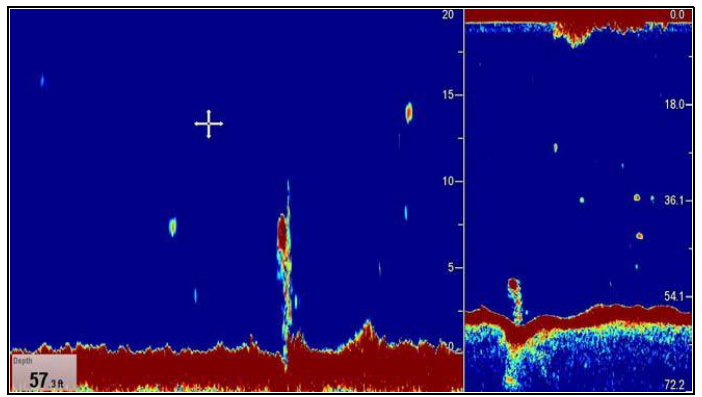

Adjusting the bottom lock range/position

From the fishfinder application, with bottom lock display mode selected:

1. Select **Menu**.
2. Select **Display Mode**.
3. Select **Bottom Lock** to switch between Full screen and Split screen
4. Select **B-Lock Range**.
Selecting Bottom Lock Range will display the B-Lock Range numeric adjust dialog.
5. Adjust the setting to the required value.
6. Select **Back** or use the **Ok** button to confirm the setting.
7. Select **B-Lock Shift** to reposition the image onscreen.
Selecting Bottom Lock Shift will display the B-Lock Shift numeric adjust dialog.
8. Adjust the setting to the required value.
9. Select **Back** or use the **Ok** button to confirm the setting.

19.12 SideVision™ Views

When connected to a **SideVision™** sonar module the default view displays both **Left** (port) and **Right** (starboard) views at the same time, the View icons and View menu can be used to switch between left and right views or both.

View: Both

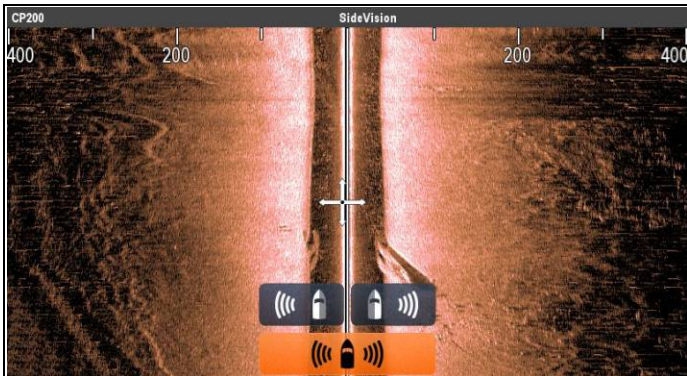

View: Left

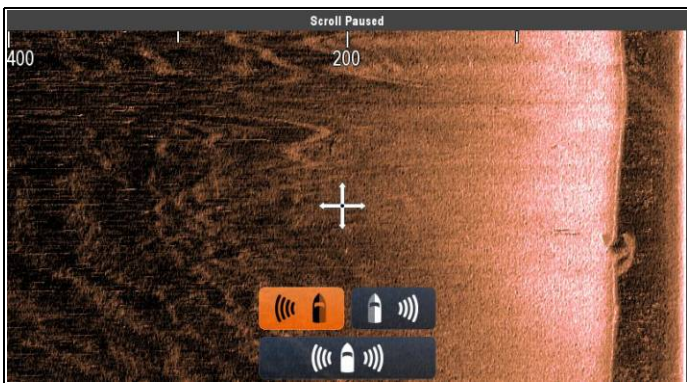

View: Right

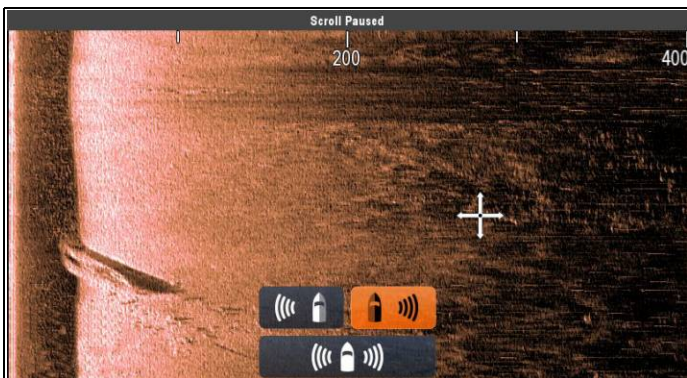

Selecting a SideVision™ view

When viewing a **SideVision™** channel on an MFD with a touchscreen, you can select which channel you want to display in the Fishfinder application using the View icons.

From the Default **SideVision™** view:

1. Select the on-screen view icon, located in the bottom right corner of the screen

The View icons are displayed in the bottom center area of the screen.

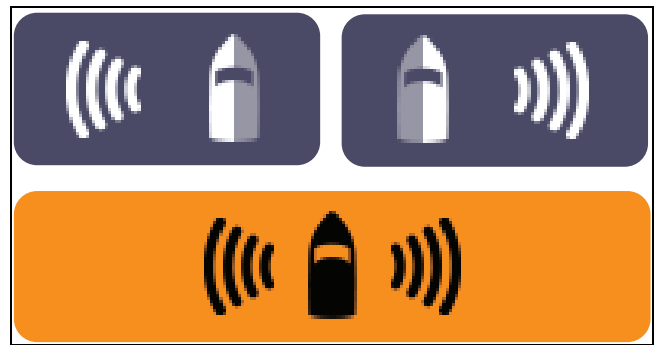

2. Select the **Left view icon** to display only the left channel.
3. Select the **Right view icon** to display only the right channel, or
4. Select the **Both view icon** to display both channel simultaneously.

Selecting a SideVision™ view using the menu.

When viewing a **SideVision™** channel on an MFD without a touchscreen or on a HybridTouch MFD, you can use the menu to select which channel you want to display in the Fishfinder application.

From the Default **SideVision™** view:

1. Select **Menu**.
2. Select **View**.
The View options are displayed.
3. Select **Left** to display only the left channel.
4. Select **Right** to display only the right channel, or
5. Select **Both** to display both channel simultaneously.

19.13 Presentation menu options

The **Presentation** menu provides access to features which provide additional on-screen detail.

The table below shows the available Presentation options.

Menu Item	Description	Options
* Target Depth ID	Controls whether the depth of identified targets are displayed. The level of targets displayed is directly linked to the level of Fish Alarm sensitivity.	<ul style="list-style-type: none"> • On • Off (default)
** Depth Lines	Controls whether horizontal lines indicating depth are displayed.	<ul style="list-style-type: none"> • On • Off (default)
*** Range Lines	Controls whether vertical lines indicating range are displayed.	<ul style="list-style-type: none"> • On • Off (default)
* White Line	When set to On, this option displays a white line along the contour of the seabed. This helps to distinguish objects close to the bottom.	<ul style="list-style-type: none"> • On • Off (default)
* Bottom Fill	When set to On, this option displays a solid color fill for the seabed.	<ul style="list-style-type: none"> • On • Off (default)

Menu Item	Description	Options
Color Palette	Various color palettes are available to suit different conditions and your personal preferences.	Traditional / CHIRP sonar channels <ul style="list-style-type: none"> • Classic Blue (default) • Classic Black • Classic White • Sunburst • Greyscale • Inverse Greyscale • Copper • Night Vision DownVision™ / SideVision™ channels <ul style="list-style-type: none"> • Copper (default) • Inv. Copper • Slate Grey • Inv. Slate Grey
Scroll Speed	Specify the fishfinder scroll speed.	<ul style="list-style-type: none"> • 100% (default) • 10% to 500%
** Gain controls	Controls whether or not the on-screen sensitivity settings are displayed.	<ul style="list-style-type: none"> • Show (default) • Hide
Databoxes Set-up	Allows you to set up and display/hide up to 2 databoxes in the bottom left corner of the screen: <ul style="list-style-type: none"> • Databox 1 • Select Data • Databox 2 • Select Data 	Databox 1 <ul style="list-style-type: none"> • On • Off Select Data Allows selection of a data type by category. Databox 2 <ul style="list-style-type: none"> • On • Off Select Data Allows selection of a data type by category.

Note:

- * Not available on **DownVision™** or **SideVision™** channels.
- ** Not available on **SideVision™**
- *** Only available on **SideVision™**

19.14 Depth and distance

Legacy, Traditional **CHIRP** and **DownVision™** sonar modules use their respective transducers to obtain depth readings. **SideVision™** can only display depth readings when a separate source for depth is available on the network.

The Fishfinder application provides a number of features to help you determine depth and distance.

Note: The VRM is only available in Bottom Lock mode when viewing the display mode in **Split** screen.

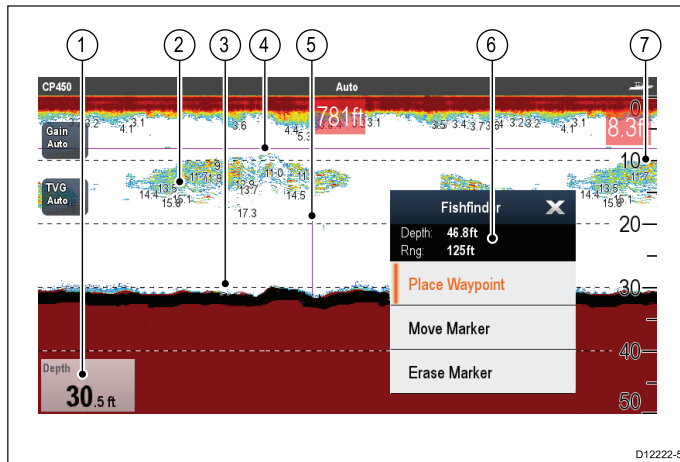

	Description
1	Depth reading — current depth of bottom.
2	Depth Target ID — depths are displayed against recognized targets. The sensitivity of these IDs is directly linked to the Fish Alarm sensitivity; the greater the fish alarm sensitivity, the greater the number of labelled targets.
3	Depth lines — horizontal dashed lines drawn at regular intervals to indicate the depth from the surface.
4	Horizontal VRM marker — indicates the depth of the target.
5	Vertical VRM marker — indicates the distance behind your vessel.
6	Cursor Depth — this is the depth of the cursor position. Cursor Range — this is the range from your vessel to the cursor position.
7	Depth markers — these numbers indicate depth.

Measuring depth and distance with VRM

You can use a Variable Range Marker (VRM) to determine an object's depth and distance behind your vessel. These markers consist of a horizontal (depth) line and a vertical (distance) line, each of which are labelled with the appropriate measurement.

From the Fishfinder application:

1. Select **Menu**
2. Select **Scroll** so that Pause is highlighted (This may make it easier to position the marker).
Selecting Scroll will switch the scroll between Pause and Resume.
3. Select the location you want to place the marker.
4. Open the **Fishfinder context menu**.
5. Select **Place Marker**.

Once placed you can move the marker by selecting **Move Marker** from the Fishfinder context menu.

19.15 Waypoints in the Fishfinder application

Placing a waypoint in the Fishfinder application enables you to mark a position so that you can return to it later.

When a waypoint is placed its details are added to the waypoint list and a vertical line showing the waypoint symbol is displayed on-screen. The waypoints can then be navigated from the Chart application.

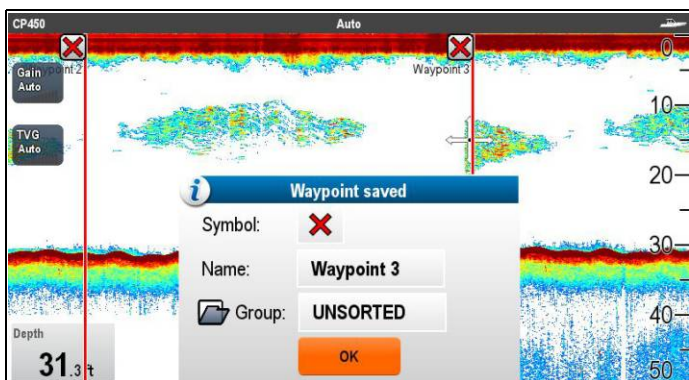

Placing a Waypoint in the fishfinder application

From the fishfinder application:

1. Select and hold the required location.
The fishfinder context menu is displayed.
2. Select **Place Waypoint**.

Placing a waypoint using the WPT button or icon

From the fishfinder application:

1. Select **WPT**.
The waypoint menu is displayed.
2. Whilst the waypoint menu is open:
 - Select **WPT** again to place a waypoint at your vessels position, or
 - Select the appropriate option: Place Waypoint At Vessel, Place Waypoint At Cursor or Place Waypoint At Lat/lon.

Placing a Waypoint using the context menu

You can place a waypoint in the fishfinder application using the context menu.

From the Fishfinder context menu:

1. Select **Place Waypoint**.
The Waypoint is placed at the cursors location, and the new waypoint dialog is displayed.
2. Select **Ok** to accept the default waypoint details, or
3. Select a field to edit the new waypoint's details.

19.16 Sensitivity settings

The **Sensitivity settings** menu provides access to features and functions that enhances what is displayed on-screen. In most situations default values should be adequate.

The tables below show the sensitivity settings available for each sonar module type.

Legacy, traditional and CHIRP sonar modules

	CHIRP external	Traditional external	Traditional internal	Legacy external
Gain	✓	✓	✓	✓
Auto Gain Modes	✗	✗	✓	✓
Color Gain	✓	✓	✓	✓
Contrast	✗	✗	✗	✗
TVG	✓	✓	✓	✓
Auto TVG Modes	✓	✓	✗	✗
Noise Filter	✗	✗	✗	✗
Color Threshold	✓	✓	✓	✓
Power Mode	✓	✓	✓	✓

Note: * Auto TVG modes are disabled when TVG is set to manual.

DownVision™ and SideVision™ sonar modules

	DownVision™	SideVision™
Gain	✓	✓
Auto Gain Modes	✗	✗
Color Gain	✗	✗
Contrast	✓	✓
TVG	✗	✗
Auto TVG Modes	✗	✗
Noise Filter	✓	✗
Color Threshold	✓	✗
Power Mode	✗	✗

Gain

The gain settings alter the way the sonar module processes background noise. Adjusting the gain settings can improve the sonar image, however for optimum performance in most conditions, we recommend that you use the auto settings.

The gain control determines the strength above which echoes are displayed on-screen.

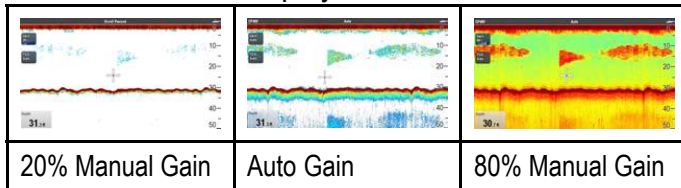

Auto

In Auto mode the sonar module automatically adjusts the gain setting to suit current conditions.

When connected to a Legacy sonar module or a Traditional internal sonar module 3 Auto Gain modes are available:

- Cruising (Low)
- Trolling (Med)
- Fishing (Fast)

Manual

If necessary you can set the gain controls manually, between a value of 0% to 100%. This value should be set high enough to see fish and bottom detail but without too much background noise. Generally a high gain is used in deep and/or clear water; a low gain in shallow and/or murky water.

The new values remain set even when you switch off the display.



On-screen gain controls

Touch only and HybridTouch multifunction displays have on-screen gain controls.

Selecting the on-screen gain control will display the gain settings:

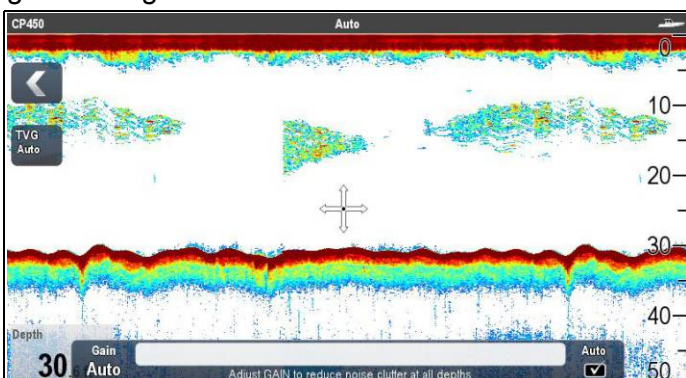

When connected to a Legacy sonar module or a traditional internal sonar module the automatic gain has 3 modes.



When connected to external CHIRP, external Traditional or DownVision™ sonar modules gain modes are not required.

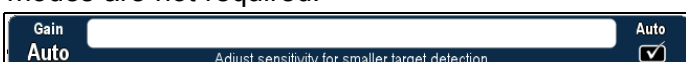

Fishfinder application

When in manual mode the slider bar control is shown.



Note: SideVision™ channels do not use on-screen Gain controls. The Gain setting can be found in the **Sensitivity Settings** menu.



Enabling and disabling on-screen gain controls

You can enable and disable the on-screen gain controls by following the steps below.

On a touchscreen multifunction display, with the relevant application displayed.

1. Select **Menu**.
2. Select **Presentation**.
3. Select **Gain Controls**.

Selecting Gain Controls will switch between showing and hiding the on-screen controls.

Note: When the on-screen Gain controls are set to Hidden then the Gain settings can be accessed directly from the application menu: **Menu > Gain**.



Adjusting gain manually using on-screen controls

1. Select the on-screen **Gain** control located on the left hand side of the fishfinder application.
2. Select the **Auto** box to switch between Auto and Manual gain.
3. With **Auto** deselected, select and hold the **Slider** and move **Left** to decrease value or **Right** to increase value.



Setting the auto gain mode using the on-screen controls

1. Select the on-screen **Gain** control located on the left hand side of the fishfinder application.
2. Select the **Auto** box so that a tick is displayed in the box.
3. Select the required **Auto Gain Mode**.

Adjusting fishfinder gain using the menu

The fishfinder gain setting can be accessed from the fishfinder menu.

From the fishfinder application:

1. Select **Menu**.
2. Select **Sensitivity Settings**.
3. Select **Gain**.

The Gain adjust dialog is displayed

4. Adjust the gain control to the required setting, or
5. Select **Auto**.

A tick is displayed in the **Auto** box to signify automatic gain is enabled.

Setting auto gain mode using the menu

When using a Legacy sonar module or a Traditional internal sonar module 3 Auto Gain modes are available. The Auto Gain mode can be set by following the steps below.

From the Fishfinder application menu:

1. Select **Sensitivity Settings**.
2. Select **Auto Gain Mode**.
3. Select the required auto gain mode.

Color gain

Traditional, CHIRP and Legacy sonar channels use different colors to determine the strength of an echo. You can adjust the color gain manually between 0% and 100% or set it to automatic.

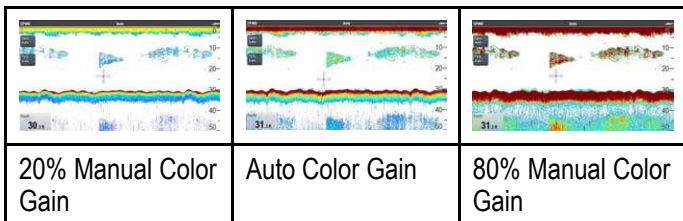

Color gain sets the lower limit for the strongest echo color. All echoes with a signal strength above this value are displayed in the strongest color. Those with a weaker value are divided equally between the remaining colors.

- Setting a low value produces a wide band for the weakest color, but a small signal band for the other colors.
- Setting a high value gives a wide band for the strongest color, but a small signal band for the other colors.

Adjusting the color gain

To adjust the color gain on Legacy and Traditional and CHIRP sonar channels follow the steps below.

From the Fishfinder application:

1. Select **Menu**.
2. Select **Sensitivity settings**.
3. Select **Color Gain**.

The color gain slider bar control is displayed.

4. Adjust the control to the required value.
5. Select **Back** to confirm setting and close slider bar, or
6. Select **Auto** to enable automatic color gain.

Contrast

DownVision™ and **SideVision™** use monochrome shading to determine the strength of echoes. You can adjust the contrast manually between 0% and 100% or set it to automatic.

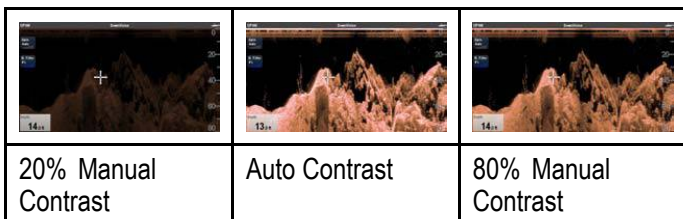

Contrast sets the lower limit for the strongest echo shade. All echoes with a signal strength above this value are displayed in the lightest shade. Those with a weaker value are divided equally between the remaining shades.

- Setting a low value produces a wide band for the darkest shade, but a small signal band for the other shades.

- Setting a high value gives a wide band for the lightest shade, but a small signal band for the other shades.

Adjusting the contrast

To adjust the contrast setting follow the steps below.

From the Fishfinder application:

1. Select **Menu**.
2. Select **Sensitivity settings**.
3. Select **Contrast**.
The Contrast slider bar control is displayed.
4. Adjust the control to the required value.
5. Select **Back** to confirm setting and close slider bar, or
6. Select **Auto** to enable automatic contrast.

Time Varied Gain (TVG)

The Time Varied Gain (TVG) setting controls the amount of attenuation applied throughout the water column, which provides a balance of shallow water returns (where echoes are strong) against deep water returns (where echoes are weak) so that targets of the same size produce echoes of the similar size regardless of target depth. The TVG setting can be manually set from 0% to 100% or set to automatic.

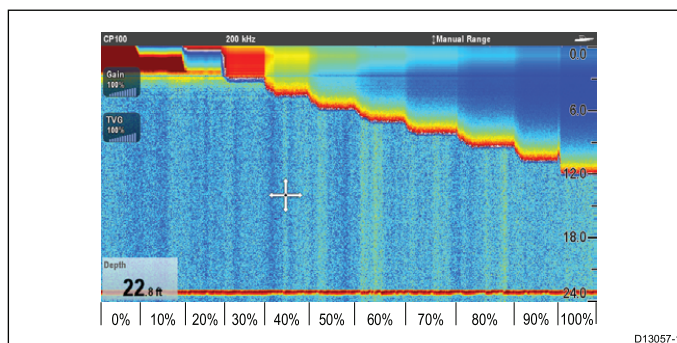

- A higher TVG setting will produce weaker targets / less clutter on-screen.
- A lower TVG setting will produce stronger targets / more clutter on-screen.

Note: TVG values between 0% and 30% represent top out mode control, values between 31% and 100% represent TVG control.

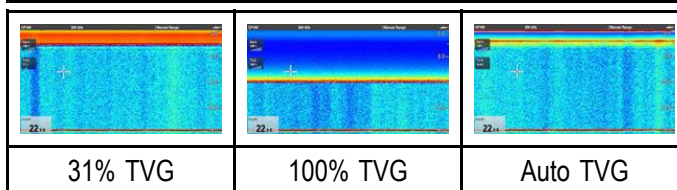

Note: TVG has no effect in simulator mode however top out mode (0% to 30%) does.

Top out mode

Top out mode is a digital filter that is combined with the TVG control. The top out mode filter reduces noise and clutter from the top portion of the sonar beam.

Top out mode is active when TVG values are between 0% and 30%. TVG values between 31% and 100% represent actual TVG control.

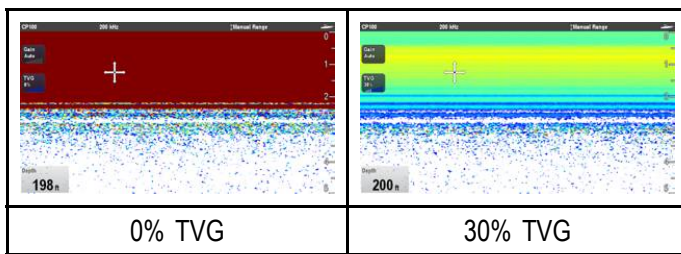

Setting TVG to Automatic

The TVG setting can be set to automatic by following the steps below.

From the Fishfinder application:

1. Select **Menu**.
2. Select **Sensitivity Settings**.
3. Select **TVG**.
The TVG slider bar control is displayed.
4. Select **Auto** so that a tick is placed in the auto box.

Auto TVG mode

When TVG is set to automatic 3 auto TVG modes are available, depending on sonar module in use.

The auto TVG modes available are as follows:

- Low
- Medium
- High

Auto TVG modes are only available on Legacy sonar modules and Traditional internal sonar modules.

Selecting an auto TVG mode

Follow the steps below to select an Auto TVG mode.

From the Fishfinder application, with TVG set to Auto:

1. Select **Menu**.
2. Select **Sensitivity Settings**.
3. Select **Auto TVG**.
4. Select the required setting: Low, Medium or High.

Manually adjusting TVG

From the Fishfinder application menu:

1. Select **Sensitivity Settings**.
2. Select **TVG**.
The TVG slider bar control is displayed.
3. Adjust the slider bar control to the required setting.
Values between 31% and 100% represent TVG control.
4. Select **Back** or **OK** to close slider bar control.



On-screen TVG controls

Touch only and HybridTouch multifunction displays have on-screen TVG controls.

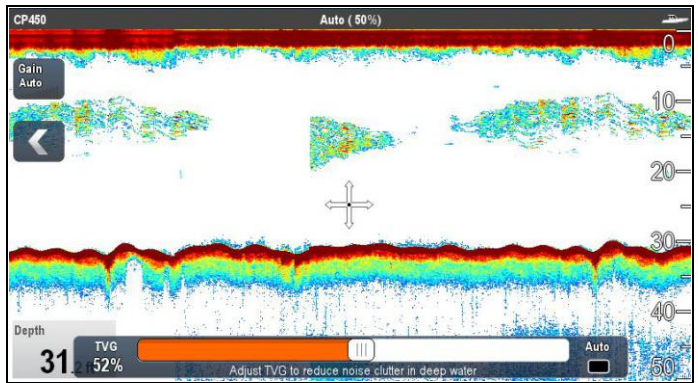

Selecting the on-screen TVG control will display the TVG settings.

When connected to an external CHIRP sonar modules (excluding DownVision™) and external Traditional sonar modules (excluding legacy) the automatic TVG has 3 modes.



When in manual mode the slider bar control is shown.



Enabling and disabling on-screen gain controls

You can enable and disable the on-screen gain controls by following the steps below.

On a touchscreen multifunction display, with the relevant application displayed.

1. Select **Menu**.
2. Select **Presentation**.
3. Select **Gain Controls**.

Selecting Gain Controls will switch between showing and hiding the on-screen controls.

Note: When the on-screen Gain controls are set to Hidden then the Gain settings can be accessed directly from the application menu: **Menu > Gain**.



Adjusting TVG manually using on-screen controls

Touch only and HybridTouch multifunction displays have on-screen TVG controls.

1. Select the on-screen **TVG** control located on the left hand side of the Fishfinder application.
2. Select the **Auto** box to switch between Auto and Manual TVG.
3. Adjust the setting to the required value.



Setting auto TVG using the on-screen controls

Touch only and HybridTouch multifunction displays have on-screen TVG controls.

1. Select the on-screen **TVG** control located on the left hand side of the fishfinder application.
2. Select the **Auto** box to select Auto TVG mode.

- When connected to external CHIRP sonar modules (excluding DownVision™) and external traditional sonar modules (excluding legacy) you can select an auto TVG mode,

A low setting would result in only the strongest colors or lightest shades being displayed.

Adjusting the color threshold

The color threshold's default value is 100%, you can adjust this setting so that less colors / shades are displayed.

From the Fishfinder application menu:

- Select **Sensitivity Settings**.
- Select **Color Threshold**.
- Adjust the color threshold to the required value.
- Select **Ok** to confirm setting and close the numeric adjust control.

Noise Filter

The Noise Filter is available on DownVision™ sonar modules. The Noise Filter reduces the amount of clutter displayed on-screen by varying the gain throughout the column of water.

The Noise Filter can be set to automatic or adjusted manually:

- Automatic** — In Auto mode the Noise Filter is set to 20%.
- Manual** — You can adjust the Noise Filter manually, between a value of 0% to 100%.
 - A low value decreases the depth at which the filter is applied.
 - A high value increases the depth at which the filter is applied.

The new values remain set even when you switch off the display.

Adjusting the Noise Filter

Follow the steps below to adjust the Noise Filter.

From the Fishfinder application:

- Select **Menu**.
- Select **Sensitivity Settings**.
- Select **Noise Filter**.

The Noise filter slider bar control is displayed.

- Adjust the Noise Filter to the required value, or
- Select the **Auto** check box to switch to Auto mode.

Note: The Noise filter can also be adjusted by selecting the on-screen **N. Filter** control.

Power mode

Power mode controls the power level of the transducer. Power mode can be set to automatic or adjusted manually between 0% and 100%. Power mode is only available on CHIRP, Traditional and Legacy sonar modules.

- Auto** — This is the default setting. When auto is selected the sonar module automatically determines the optimum setting based on the current depth, speed, and (bottom) signal strength.
- Manual** — You can adjust the power level between in 1% increments. Lower power levels are normally used in depth ranges less than 2.4 m (8 ft.) and higher power levels are typically selected for depths greater than 3.7 m (12 ft.).

Adjusting the transducer power level

From the Fishfinder application menu:

- Select **Sensitivity settings**.
- Select **Power Mode**.

The power mode slider bar control is displayed.

- Adjust the slider bar to the required setting, or
- Select **Auto** to set automatic power mode.

Color threshold

Color threshold determines the signal strength below which targets are not shown. Traditional and CHIRP sonar use different colors to determine signal strengths whilst DownVision™ uses monochrome shading.

The Color Threshold setting is a global setting. When the color threshold value is changed all Fishfinder application panes on all networked multifunction displays will share the same color threshold value.

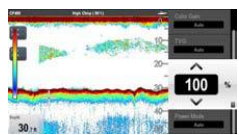
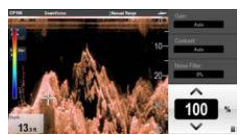
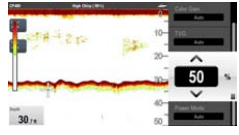
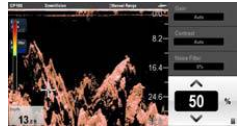
Color threshold	Traditional / CHIRP channels	DownVision™ channel
100% (default)		
50%		

19.17 Fishfinder alarms

The following Fishfinder alarms can be set when a depth data source is available.

- **Fish** — alarm sounds when a target meets the specified sensitivity level and, is within the depth limits (if enabled).
- **Fishfinder Deep** — alarm sounds when the detected depth is greater than the deep limit.
- **Fishfinder Shallow** — alarm sounds when the detected depth is less than the shallow limit.

Setting up fish alarms

From the Alarms menu **homescreen > Set-up > Alarms:**

1. Select **Fish**.
The Fish alarms menu is displayed.
2. Select **Fish** so that On is highlighted.
3. Select **Fish Sensitivity**.
The fish sensitivity numeric adjust control is displayed.
4. Adjust the fish sensitivity to the require value.
The greater the fish alarm sensitivity, the greater the number of target image depths displayed.
5. Select **Fish Depth Limits** so that **On** is highlighted.
The shallow and deep fish limit settings will be activated in the menu.
6. Select **Shallow Fish Limit**.
The shallow fish limit numeric adjust control is displayed.
7. Adjust the value to the require setting.
8. Select **Ok** to confirm the new value and close the numeric adjust control.
9. Select **Deep Fish Limit**.
The deep fish limit numeric adjust control is displayed.
10. Adjust the value to the require setting.
11. Select **Ok** to confirm the new value and close the numeric adjust control.

Setting up fishfinder deep alarm

From the Alarms menu **homescreen > Set-up > Alarms:**

1. Select **Fishfinder Deep**.
2. Select Deep so that On is highlighted.
Selecting Deep will switch between On and Off.
3. Select **Deep Limit**.
The deep limit numeric adjust control is displayed.
4. Adjust the setting to the required value.
5. Select **Ok** to confirm the new value and close the numeric adjust control.

Note: The Deep Limit cannot be set to less than the Shallow Limit.

Setting up fishfinder shallow alarm

From the Alarms menu **homescreen > Set-up > Alarms:**

1. Select **Fishfinder Shallow**.
2. Select Shallow so that On is highlighted.
Selecting Shallow will switch between On and Off.
3. Select **Shallow Limit**.
The shallow limit numeric adjust control is displayed.
4. Adjust the setting to the required value.
5. Select **Ok** to confirm the new value and close the numeric adjust control.

Note: The Shallow Limit cannot be set to greater than the Deep Limit.

19.18 Frequency tuning

The frequency is dependent on the sonar module and transducer in use. When using a non-CHIRP sonar module or a CHIRP sonar module that is operating in non-CHIRP mode then the transducer's frequency can be manually fine-tuned.

The advantages of being able to tune the frequency include:

- Optimization for particular species of fish and water conditions.
- Avoiding interference from other sonar operating nearby (at the same frequency).
- Use of wide or narrow beam on a particular transducer.

Traditional and Legacy frequency tuning

The following frequency types are available on Legacy and Traditional sonar modules:

- **Auto** — When operating in automatic no fine-tuning is needed as the system will set the frequency automatically to suit your transducer's operating conditions.
- **Lower frequencies** — (e.g. 50 kHz) — Produces a wide sonar beam and penetrate the water well. Lower frequencies provide a lower resolution image that may not be as good at detecting small fish. Use lower frequencies if you require a large coverage beneath your vessel or if you are in deep water.
- **Higher frequencies** — (e.g. 200 kHz) — Produces a narrow beam and produce a high resolution image. They are most useful in shallower water (up to 1000 ft) and at higher speeds.

The graph below depicts fine-tuning of a Traditional or Legacy sonar frequency (from -50% to +50%).

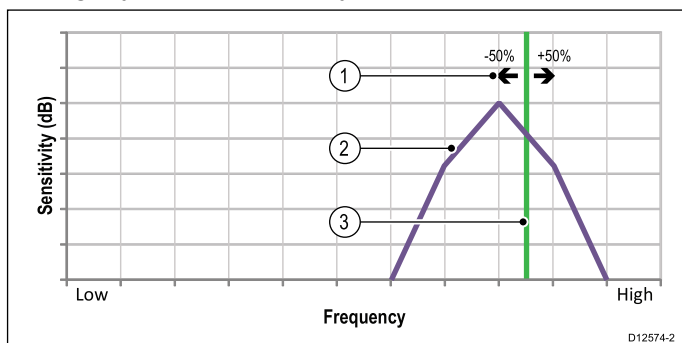

1. Tuning range
2. Transducer characteristics
3. Operating frequency

CHIRP frequency tuning

The list below provides details of the frequency types available when using a CHIRP sonar module.

- **Auto** — When operating in automatic no fine-tuning is needed as the system will set the frequency automatically to suit your transducer's operating conditions.
- **Low frequency** — non-CHIRP mode (e.g. 50 kHz) — Produces a wide sonar beam and penetrate the water well. Lower frequencies provide a lower resolution image that may not be as good at

detecting small fish. Use lower frequencies if you require a large coverage beneath your vessel or if you are in deep water.

- **Medium frequency** — non-CHIRP mode (e.g. 90 kHz) — Produces good detail at most depths, with moderately wide sonar beam.
- **High frequency** — non-CHIRP mode (e.g. 160 kHz) — Produces a narrow beam and produce a high resolution image. They are most useful in shallower water (up to 1000 ft) and at higher speeds.
- **Low Chirp** — CHIRP mode (e.g. 42 to 65 kHz) — No fine-tuning is not needed as the CHIRP sonar module will sweep the transducer's available frequency range in each ping.
- **Med Chirp** — CHIRP mode (e.g. 85 to 135 kHz) — No fine-tuning is not needed as the CHIRP sonar module will sweep the transducer's available frequency range in each ping.
- **High Chirp** — CHIRP mode (e.g. 130 to 210 kHz) — No fine-tuning is not needed as the CHIRP sonar module will sweep the transducer's available frequency range in each ping.

With the CHIRP sonar module set to a non-CHIRP mode the frequency can be fine tuned to adjust the frequency at which the transducer is transmitting.

The graph below depicts fine-tuning of a CHIRP broadband sonar frequency (from -50% to +50%).

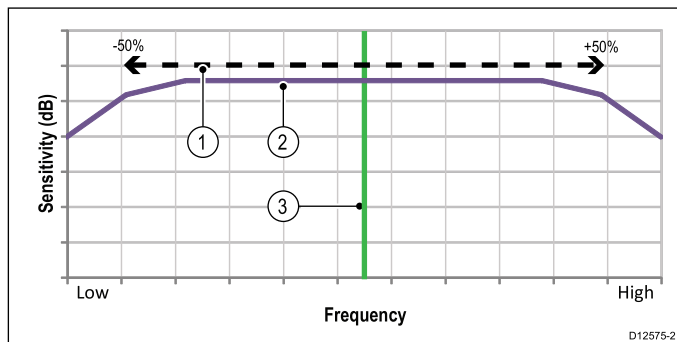

1. Tuning range
2. Transducer characteristics
3. Operating (center) frequency

Fine-tuning the sonar frequency

When connected to a Traditional or Legacy sonar module or when operating a CHIRP sonar module in non-CHIRP mode the transmit frequency can be fine-tuned.

From the Fishfinder application:

1. Ensure that the channel frequency that you want to fine-tune is displayed in the active Fishfinder pane.
2. Select **Menu**.
3. Select **Set-up**.
4. Select **Sounder Set-up**.
5. Select **Tune Frequency**.
The frequency adjust control is displayed.
6. Adjust the frequency until optimum results are achieved.

19.19 Sounder set-up menu options

This section details the options available in the Sounder set-up menu: (**Menu > Set-up > Sounder Set-up**).

Menu Item	Description	Options
* Ping Rate	Hyper Ping is a setting only available on Traditional internal and Legacy sonar modules, for use in shallow waters (depth range set to 6 meters (20 feet) or less. In depths of over 6 meters (20 feet) the ping rate will revert to normal until depth conditions are met. When set to Hyper the display will provide an accurate, undistorted image of the bottom at speeds of up to 40 kts.	<ul style="list-style-type: none"> • Normal (default) • Hyper
* Ping Rate Limit	Provides a speed limiter; it is useful to adjust the ping rate limit to suit local conditions. For example, the ping rate may be too fast when there is a hard bottom in shallow water. Note: Ping rate limit is disabled if Ping Rate is set to Hyper.	<ul style="list-style-type: none"> • DownVision™ sonar: 5 to 80 pings per second. • Legacy and Traditional Internal sonars: 5 to 50 pings per second. • CHIRP and traditional external sonars: 5 to 30 pings per second.
Ping Enable	The sonar ping can be disabled. This is useful when other equipment is being tested, or if someone is diving beneath the boat. This setting reverts to Enabled when the sonar module is powered off.	<ul style="list-style-type: none"> • On • Off
* Tune Frequency	Enables non-CHIRP channel frequencies to be manually tuned.	<ul style="list-style-type: none"> • -50% to +50%
* Interference rejection	Removes spikes caused by other fishfinder-equipped vessels. Note: Interference rejection is disabled if Ring Rate is set to Hyper.	<ul style="list-style-type: none"> • Auto • Low • Medium • High • Off
* 2nd Echo IR	Adjusts the ping rate in small increments, according to the 2nd echo level. This results in better sensitivity of the image. Note: 2nd Echo IR is disabled if Ring Rate is set to Hyper.	<ul style="list-style-type: none"> • Off • Low • High
Sonar reset	Restore all settings on the sonar module to factory default. When performing a sonar Reset, it is normal to briefly lose connection with the sonar module. Transducer selection is not affected by the Sonar Reset operation.	<ul style="list-style-type: none"> • Yes • No
Trip Reset	Resets the Trip Counter of the sonar module	<ul style="list-style-type: none"> • Yes • No

Note: * Not applicable to **SideVision™**.

19.20 Transducer set-up menu options

The **Transducer Set-up** menu should be used when setting up your multifunction display for the first time or when installing a depth transducer.

Note: The settings listed below will only be available if the connected transducer supports the data type.

Menu Item	Description	Options
Transducer	Select the appropriate transducer type from those displayed. Some transducers may be detected by the system automatically.	Options available are dependent on the sonar module connected.
Speed Transducer	Select the appropriate speed transducer from those available. This option is only available if you are not using a combined Depth/Speed or Depth/Speed/Temperature transducer.	Options available are dependent on the sonar module connected.
Depth Offset	Offset represents the depth of the transducer relative to: <ul style="list-style-type: none"> • Waterline = 0.0 ft and above. • Keel = 0.1 ft and below. 	<ul style="list-style-type: none"> • -9.8 to +9.8 feet — or equivalent units
Speed Offset	Offset applied to the speed log.	<ul style="list-style-type: none"> • 0 to 100%
Temperature Offset	Offset applied to the temperature transducer value.	<ul style="list-style-type: none"> • -9.9 to +9.9 °F — or equivalent units

19.21 Resetting the sonar

The reset function restores the unit to its factory default values.



Note: Performing a factory reset will clear speed and temperature calibration settings and the depth offset.

1. Using a compatible Raymarine multifunction display go to the Fishfinder application page.
2. Select **Menu** from the side menu.
3. Select **Set-up**.
4. Select **Sounder Set-up**.
5. Select **Sonar reset**.
6. Select **Yes** to confirm.

The unit will now be reset to factory default settings.

Chapter 20: Data application

Chapter contents

- 20.1 Data application overview on page 282
- 20.2  Selecting datapages using touch on page 284
- 20.3  Selecting datapages on page 285
- 20.4 Customizing the data application on page 285
- 20.5 List of data items on page 287
- 20.6 Engine identification on page 294
- 20.7 Setting boat details on page 296
- 20.8 Setting maximum engine RPM on page 296
- 20.9 Color theme on page 297
- 20.10 Units set-up on page 298
- 20.11 Resetting minimum and maximum readings on page 299
- 20.12 Resetting all datapages on page 299

20.1 Data application overview

The Data application enables you to view data generated by the multifunction display or data that is available on your system.

Data can be obtained from devices connected using SeaTalk^{hs}, SeaTalk^{ng} or NMEA protocols.



Pre-configured datapages

The default datapage configuration is dependant upon the boat type selected during the initial set-up wizard.

Each datapage consists of a number of 'cells', that display the information.

Default datapage configuration is shown below:

Motor vessel		Sailing vessel	
Page number	Page	Page number	Page
1/6	Engine	1/5	Engine
2/6	Navigation	2/5	Navigation
3/6	Environment	3/5	Sailing
4/6	Fishing	4/5	Environment
5/6	Fuel	5/5	Rolling road
6/6	Rolling road		

Note: Datapage selection is a local setting, and therefore only affects the individual display that you are currently using. It does not affect any networked displays.

Engine page

The Engine page is available for all boat types. The dials and type of data displayed is dependent on the **Number of engines** set in the Boat Details settings.

Important: The relevant engine data must be available on your network for the Engine page to show engine data.

Example — engine page for 2 engine vessel.

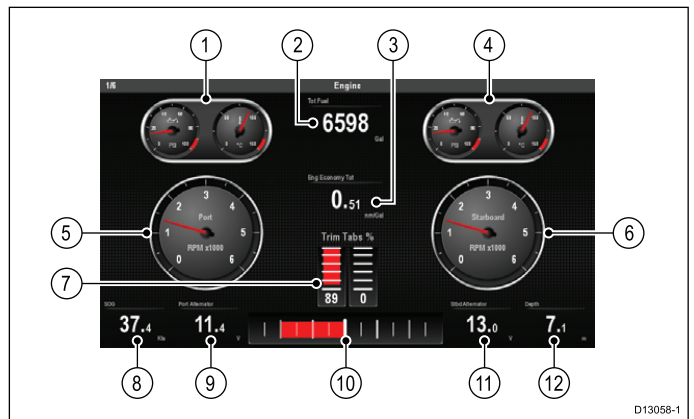

1. Port engine combined oil pressure and coolant temperature dial
2. Total fuel
3. Engine Economy total
4. Starboard engine combined oil pressure and coolant temperature dial
5. Port engine RPM dial
6. Starboard engine RPM dial
7. Trim tabs
8. SOG
9. Port alternator
10. Rudder bar
11. Starboard alternator
12. Depth

Navigation page

The Navigation page is available for all boat types.

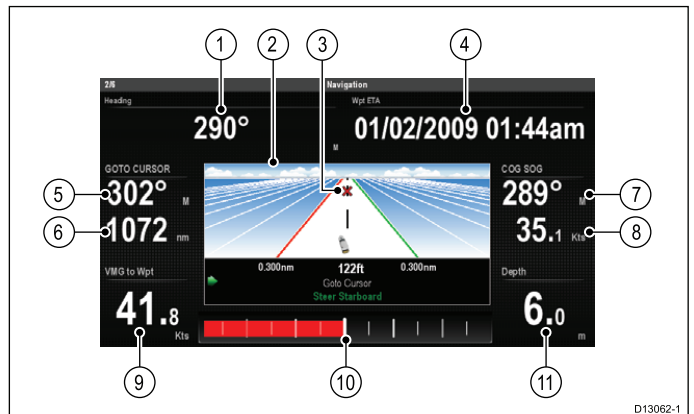

1. Heading
2. Rolling road
3. Target waypoint
4. Waypoint ETA (Estimated time of arrival)
5. Heading to target waypoint
6. Distance to target waypoint
7. COG
8. SOG
9. VMG to waypoint
10. Rudder bar
11. Depth

Sailing page

When the boat type has been configured as a sailing vessel, the Sailing page is available in the Data application.

The Sailing page includes compass and wind dials that displays various data designed specifically for sailing vessel.

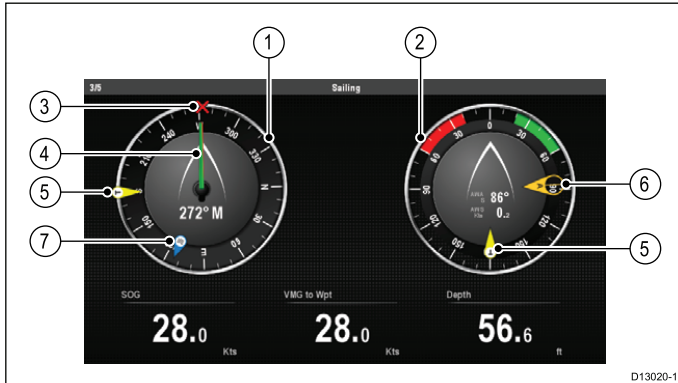

1. **Compass dial**
2. **Wind dial**
3. **Waypoint icon** — Only displayed during active navigation.
4. **Heading** (red) and **COG** (green) arrows
5. **True wind arrow** (yellow)
6. **Apparent wind arrow** (yellow)
7. **Tide arrow** (blue)

Environment page

The Environment page is available for all boat types.

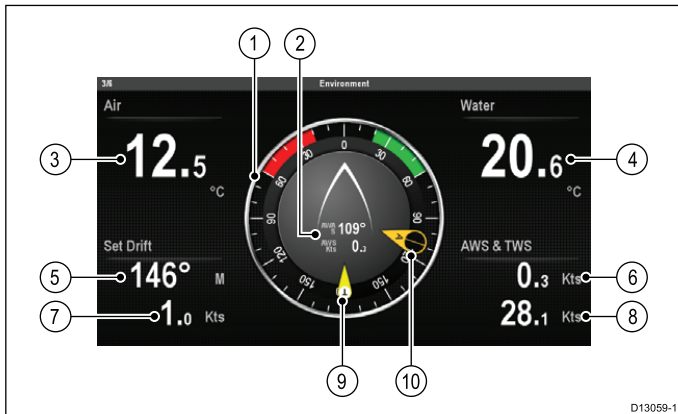

1. Wind dial
2. AWAS and AWS
3. Air temperature
4. Water temperature
5. Set
6. AWS
7. Drift
8. TWS
9. True wind arrow
10. Apparent wind arrow

Fishing page

The Fishing page is available when the boat type is set to a motor vessel.

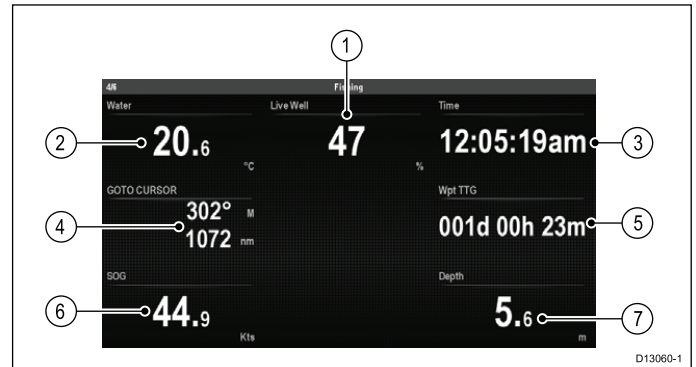

1. Water temperature
2. Live well
3. Time
4. Target waypoint range and bearing
5. Waypoint TTT
6. SOG
7. Depth

Fuel page

The Fuel page is available when the boat type is set to a motor vessel.

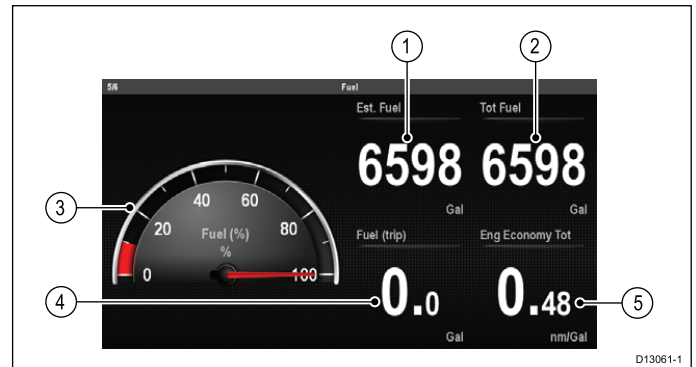

1. Estimated fuel
2. Total fuel
3. Fuel gauge
4. Fuel (trip)
5. Engine economy total

Rolling road

The Rolling road page is available for all boat types.

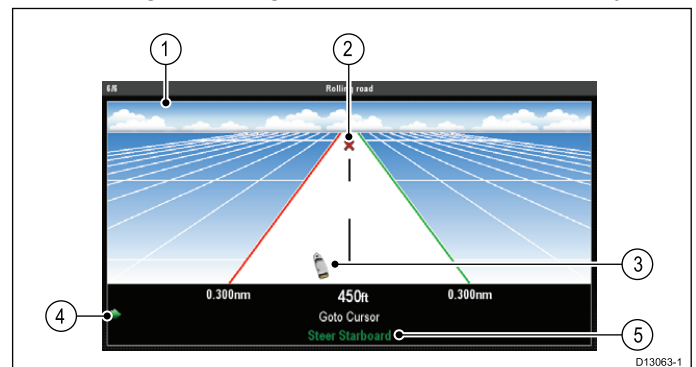

1. Rolling road
2. Target waypoint
3. Vessel icon

- 4. Course correction indicator
- 5. Course correction details

20.2 Selecting datapages using touch

You can scroll through all available pages using the touchscreen.

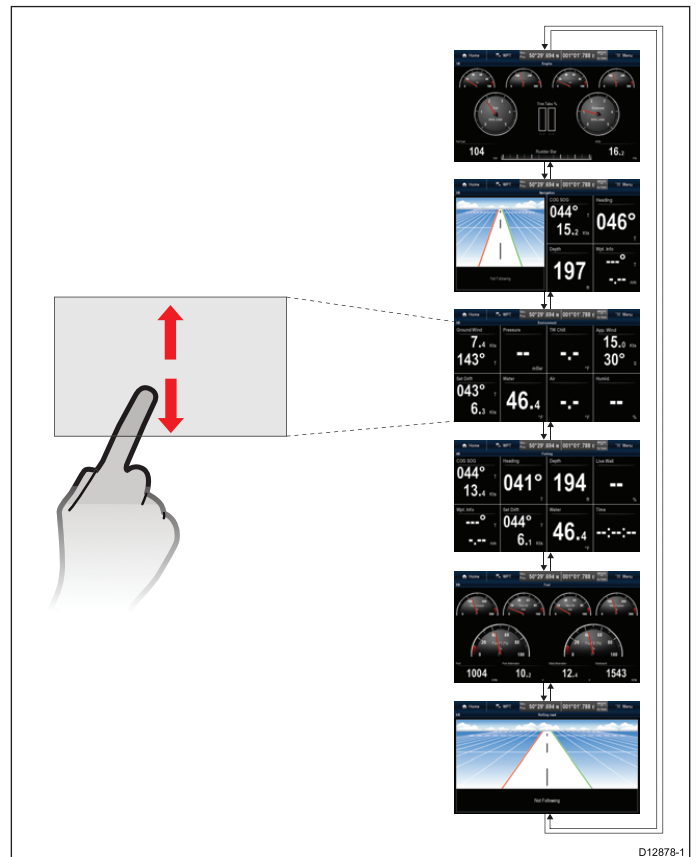

From the Data application:

1. Touch the screen.
2. Slide your finger up and let go of the screen to go to the next datapage.
3. Slide your finger down and let go of the screen to go to the previous datapage.

20.3 Selecting datapages

To select datapages using a non-touch multifunction display follow the steps below.

From the data application:

1. Move the **Joystick Down** to goto the next page, or
2. Move the **Joystick Up** to goto the previous page.

20.4 Customizing the data application

You can customize the data application to show the system and instrument data that you require.

In addition to displaying the default, pre-configured datapages in the data application, you can also:

- Change the order datapages appear.
- Customize datapages content to your specific requirements.
- Rename the datapages.
- Add new custom datapages.
- Delete existing datapages.
- Set boat details such as number of engines, fuel tanks, and batteries.
- Set the maximum engine RPM range.
- Change color theme.
- Change the units of measurement.
- Reset minimum and maximum readings.
- Reset all pages to default.

Changing datapage order

You can change the order that datapages appear.

From the data application:

1. Scroll to the datapage you want to move.
2. Select **Menu**.
3. Select **Edit Page**.
The edit page menu is displayed.
4. Select **Move Page Up** or **Move Page Down**.
Each time move page up or move page down is selected the datapage will be moved 1 space up or down in the data application.



Customizing datapage content using touch

On touchscreen multifunction displays you can customize a data item by pressing and holding on the item onscreen.

From the Data application:

1. Display the datapage that contains the data item you want to change.
2. Touch and hold your finger on the data item.
After approximately 3 seconds the data item is highlighted and the **Select Data Category** menu is displayed.
3. Navigate the menu to locate the data item you want to use.
4. Select the data item.
The selected data item is now displayed in place of the original data item.

Customizing datapage content

From the data application:

1. Select **Menu**.
2. Select **Edit Page**.
3. Select the cell you want to change.
4. Select **Select Data Category**.

5. Select a data category.
Selecting a data category will display a list of data items for that category.
6. Select the data item you want to display.
Once selected a tick will be placed next to the data item in the menu and the cell on screen will display the new data item
7. Repeat steps 3 to 6 for all the data items you want to change.

Renaming a datapage

From the data application:

1. Select **Menu**.
2. Select **Edit Page**.
3. Select **Rename Page**.
The on screen keyboard is displayed.
4. Enter the new name for the datapage.
5. Select **SAVE**.

Adding a new datapage

You can add your own customized datapages to the data application. The total number of datapages including pre-configured pages is 10.

From the data application:

1. Select **Menu**.
2. Select **Create New Page**.
A list of available page layouts is displayed.
3. Select the required page layout.
The new page is displayed on screen.

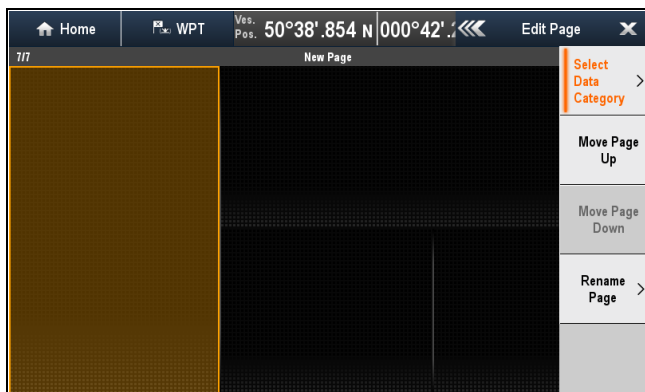

4. Select the blank cell on the new page layout that you want to add a data item to.
5. Select **Select Data Category**.
6. Select a data category.
Selecting a data category will display a list of data items for that category.
7. Select the data item you want to display.
Once selected a tick will be placed next to the data item in the menu and the cell on screen will display the selected data item.
8. Repeat steps 3 to 6 for all the data items you want to change.
9. Select **Rename Page**.
The on screen keyboard is displayed.
10. Enter the new name for the datapage.
11. Select **SAVE**.

Deleting a datapage

You can delete custom or pre-configured datapages from the data application. The minimum number of datapages allowed is 1.

From the data application:

1. Scroll to the datapage you want to delete.
2. Select **Menu**.
3. Select **Delete Page**.
The confirm delete pop up message is displayed.
4. Select **Yes** to delete the datapage, or **No** to cancel the action.















































Note: You cannot create a new engine page with the same layout as the pre-configured engine datapages.



































20.5 List of data items





























Categories of data available to display in the data application, databoxes, databar, and expanded databar are shown below. Dial graphics are not available in databoxes or databars.





































The following table shows the data items available by category.



































Data Category	Description	Data Item	Data application Graphics			
Battery**	Battery status	Battery Amps				
		Battery Temperature				
		Battery Voltage				
		Battery Charge				
Boat	Types of data generated by your vessel. For example, tank levels.	Rate of Turn				
		Heel Angle				
		Trim Tabs (Data application only.)				
Depth	Depth data.	Depth				
		Maximum Depth				
		Minimum Depth				
Distance	Types of data related to distance travelled by your vessel. For example, trip distance.	Log & Trip				
		Log				
		Trip				
		Ground Log and Trip				
		Ground Log				
		Ground Trip 1				
		Ground Trip 2				
		Ground Trip 3				
Ground Trip 4						

















Data Category	Description	Data Item	Data application Graphics			
Engine**	Types of data generated by engines. For example, oil pressure.	RPM				
		RPM & SOG				
		Coolant Temperature				
		Coolant Pressure				
		Oil Temperature				
		Oil Pressure				
		Oil Pressure & Coolant Temperature				
		Transmission Oil Temperature				
		Transmission Oil Pressure				
		Transmission Gear				
		Boost Pressure				
		Fuel Pressure				
		Fuel Flow Rate				
		Fuel Flow (Inst)				
		Fuel Flow (Avg)				
		Engine Hours				
		Engine Trim				
		Alternator				
Engine Load						

Data Category	Description	Data Item	Data application Graphics			
Fuel**	Types of data related to the fuel system. For example, fuel levels.	Fuel Level (%)				
		Total Fuel (%)				
		Total Fuel (vol)				
		Fuel Flow Total				
		Economy				
		Estimated Fuel Remaining				
		Distance to Empty				
		Time to Empty				
		Fuel Used (Trip)				
		Fuel Used (Season)				
Environment	Environmental-related data. For example, air temperature.	Pressure				
		Air Temperature				
		Minimum Air Temperature				
		Maximum Air Temperature				
		Drift				
		Set				
		Set & Drift				
		Apparent Wind Chill				
		True Wind Chill				
		Humidity				
		Dew Point				
		Sunset / Sunrise				
Water Temperature						

Data Category	Description	Data Item	Data application Graphics			
		Minimum Water Temperature				
		Maximum Water Temperature				
GPS	GPS-related data. For example, vessel position.	Vessel Position				
		COG & SOG				
		COG				
		SOG				
		Maximum SOG				
		Average SOG				
Heading	Heading-related data. For example, locked heading.	Heading				
		Heading and Speed (Data application only.)				
		Locked Heading				
		Locked Heading Error				
		LH Error and LH (Data application only.)				
		Tack Heading				
		Compass (Data application only.)				
Navigation	Types of data related to navigation. For example, bearing to waypoint.	Cursor Position (Only available in the Databar and data overlay.)				
		Cursor info (Only available in the Databar and data overlay.)				
		Cross Track Error				
		Rolling Road (Data application only.)				

Data Category	Description	Data Item	Data application Graphics			
		Waypoint Info				
		Active Waypoint Name				
		Target Position				
		Bearing to Waypoint				
		BTW & DTW (Data application only.)				
		Course Made Good				
		CMG & DMG				
		CMG & VMG (Data application only.)				
		Distance to Waypoint				
		Distance Made Good				
		Waypoint ETA				
		Waypoint TTG				
		Route ETA				
		Route TTG				
Pilot	Pilot-related data. For example, rudder.	Rudder Angle				
Speed	Speed-related data. For example, VMG (Velocity Made Good) to Waypoint.	Speed				
		Maximum Speed				
		Average Speed				
		Speed and SOG				
		VMG to Windward				
		VMG to Waypoint				

Data Category	Description	Data Item	Data application Graphics			
Tanks**	Data related to water tanks	Fresh Water (%)				
		Grey Water (%)				
		Black Water (%)				
		Live Well (%)				
Time	Time-related data. For example, local time.	Local Time				
		Local Date				
Wind	Wind-related data. For example, VMG (Velocity Made Good) to Windward.	AWA				
		Maximum AWA				
		Minimum AWA				
		AWS				
		Maximum AWS				
		Minimum AWS				
		TWA				
		Maximum TWA				
		Minimum TWA				
		TWS				
		Maximum TWS				
		Minimum TWS				
		TWD				
		Cardinal Wind				
		Ground Wind				
Beaufort						
AWA and TWA						

Data Category	Description	Data Item	Data application Graphics			
		AWA & AWS				
		AWA (CH) and AWS				
		AWA and VMG				
		TWA & TWS				
		TWA (CH) and TWS				
		TWA and VMG				
		GWD and Beaufort				
		GWD & GWS				
None						

Note: *Dials and graphical representations are only available from the Data application. Databar and data cell overlays can only display digital items.

Note: **The Battery, Engine, Fuel and Tanks menus will display 1 set of data items per configured device (e.g. if the system has been configured with 3 engines then 3 sets of engine data items will be displayed).

20.6 Engine identification

Engine data can be displayed on your MFD using the Data application, which provides some preset Engine pages for displaying some of the most common types of engine data.

Important: Before you can display Engine data on your MFD, you must:

- Ensure that your MFD is running LightHouse software version 8 or later.
- **Refer to the important “Engine setup with an ECI interface” and “Using the engine identification wizard” information.**
- Make the data connections, according to the instructions provided in the **87202 ECI Installation instructions**.
- Ensure all data buses are powered up (including engine data CAN buses, gateways, and also the SeaTalk^{ng} bus).
- Start the engine. It is important that only one engine is running at a time, to ensure that the system can isolate the correct engine data message.
- Run the **Engine identification wizard** to ensure that your engines are displayed in the correct order in the Data application.



Engine setup with an ECI interface

Before you can display engine data on your MFD, you may need to use the "Engine Identification wizard" on the MFD to setup the engines.

Important: When setting up on a multiple engine system, engines should always be turned on in sequence from port to starboard.

The following table details the different types of engine supported by the ECI interface unit, and the setup requirements for each:

Engine CAN bus protocol	Number of engines	Engine CAN bus configuration	Number of ECI units	Setup via wizard on MFD required
NMEA 2000	1	Single CAN bus	1	✗
NMEA 2000	2+	Single shared CAN bus	1	✗
NMEA 2000	2+	Separate CAN bus for each engine	1 for each CAN bus	✓
J1939	1	Single CAN bus	1	✗
J1939	2+	Single shared CAN bus	1	✗
J1939	2+	Separate CAN bus for each engine	1 for each CAN bus	✓

Engine interfacing without an ECI unit

For engines with a NMEA 2000 CAN bus it may be possible to connect to a Raymarine MFD via a SeaTalk^{ng} system without the use of a Raymarine ECI unit.

Refer to your engine dealer and also your local Raymarine dealer for advice on any engine instancing requirements and suitable connection cables.

Using the engine identification wizard

If your engine data appears in the wrong order on the engine data pages you can correct this by running the engine identification wizard.

From the Homescreen:

1. Select **Set-up > System Settings > External Devices > Engines Set-up**.
2. If required change the number of engines your vessel has by selecting **Num. of Engines:** and entering the correct number of engines.

You can select up to 5 engines.

3. Select **Identify engines**.

Important: It is important that only one engine is running at a time, to ensure that the system can isolate the correct engine data message.

4. Follow the onscreen prompts to complete the engine identification wizard.

The engines that will be included in the identification wizard are determined by the Number of engines set during step 2 above.

- i. Switch Off ALL vessel engines and select **Next**.

The wizard will run through all engines (max of 5 as defined in step 2 above) from port to starboard in sequence.

- ii. Turn On the **port engine** and select **OK**.
The wizard will now listen for data and assign the engine instance as the port engine.
 - iii. Turn On the **center port engine** and select **OK**.
The wizard will now listen for data and assign the engine instance as the center port engine.
 - iv. Turn On the **center engine** and select **OK**.
The wizard will now listen for data and assign the engine instance as the center engine.
 - v. Turn On the **center starboard engine** and select **OK**.
The wizard will now listen for data and assign the engine instance as the center starboard engine.
 - vi. Turn On the **starboard engine** and select **OK**.
The wizard will now listen for data and assign the engine instance as the starboard engine.
5. Select **OK** on the Identify Engines confirmation dialog.

The engines will now appear in the correct location on the engine data page.

20.7 Setting boat details

You can change vessel settings from the Data application menu.

From the Data application:

1. Select **Menu**.
2. Select **Boat Details**.
3. Select **Num. of Engines, Num. of Fuel Tanks, or Num. of Batteries**.
4. Select either 1, 2, 3, 4 or 5.

If the number of engines has been changed then the Engine datapage will be reset to display the correct number of engines.

20.8 Setting maximum engine RPM

You can set the maximum RPM range to display on the RPM data item.

From the data application:

1. Select **Menu**.
2. Select **Max RPM Range**.
A list of available RPM settings is displayed.
3. Select the required RPM range.
A tick will be placed next to the selected RPM range in the menu and the RPM range on the engine datapage will be changed to your new setting.

Examples

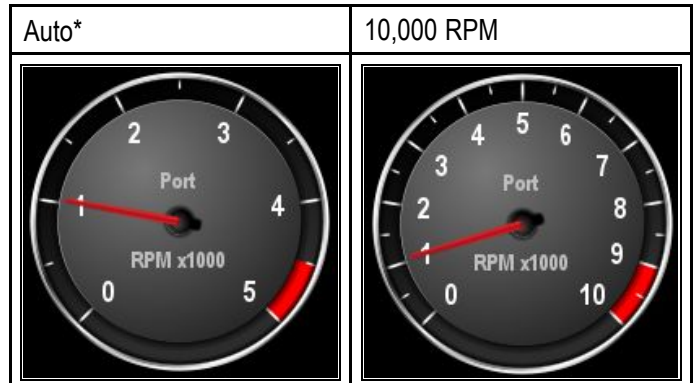

Note: *The maximum RPM when in auto mode is set by the engine.

20.9 Color theme

The color theme in the Data application can be switched between light and dark.

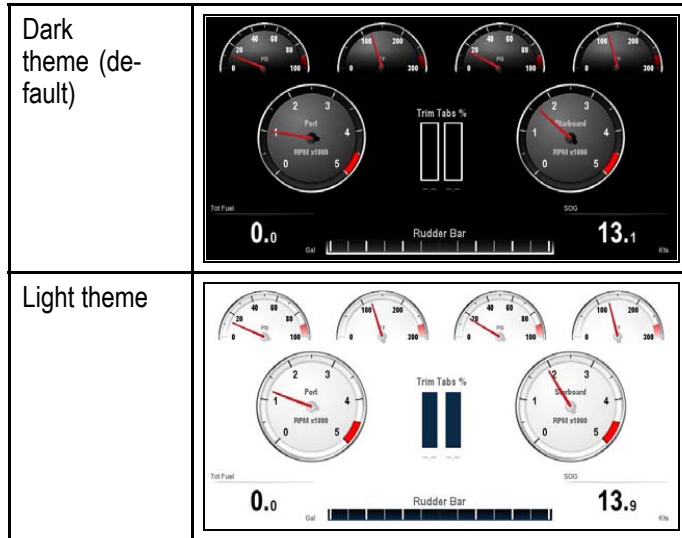

Changing the color theme

You can change the color theme by following the steps below.

From the Data application:

1. Select **Menu**.
2. Select **Presentation**.
3. Select **Color Theme**.

Selecting color theme will switch color between Light and Dark.

20.10 Units set-up

You can specify your preference for the units of measurement that will be used in all applications.

Menu item	Description	Options
Distance Units	The units of measure that will be used in all applications for the display of all values related to distance.	<ul style="list-style-type: none">• Nautical Miles• NM & m (major units = Nautical Miles, minor units = meters)• Statute Miles• Kilometers
Speed Units	The units of measure that will be used in all applications for the display of all values related to speed.	<ul style="list-style-type: none">• Knots• MPH (Miles Per Hour)• KPH (Kilometers Per Hour)
Depth Units	The units of measure that will be used in all applications for the display of all values related to depth.	<ul style="list-style-type: none">• Feet• Meters• Fathoms
Temperature Units	The units of measure that will be used in all applications for the display of all values related to temperature.	<ul style="list-style-type: none">• Fahrenheit• Celsius
Pressure Units	The units of measure that will be used in all applications for the display of all values related to pressure.	<ul style="list-style-type: none">• Bar• PSI• Kilopascals
Volume Units	The units of measure that will be used in all applications for the display of all values related to volume.	<ul style="list-style-type: none">• US Gallons• Imperial Gallons• Liters
Economy Units	The units of measure that will be used in all applications for the display of all values related to fuel usage.	<ul style="list-style-type: none">• Distance per Volume• Volume per Distance• Liters per 100 km
Wind Speed Units	The units of measure that will be used in all applications for the display of all values related to wind speed.	<ul style="list-style-type: none">• Knots• Metres per second

Changing units of measure

You can change the units of measure used by the multifunction display.

From the Data application:

1. Select **Menu**.
2. Select **Units Set-up**.
3. Select the type of measurement you want to change.
4. Select the new unit of measure.

20.11 Resetting minimum and maximum readings

Minimum and maximum readings sorted on the display can be reset from the Data application.

From the Data application, with the data you want to reset displayed onscreen:

1. Select **Menu**.
2. Select **Data Resets**.
3. Select the data item you want to reset.

The reading is reset.

Note: Resets will only be available for data items that are currently displayed onscreen.

20.12 Resetting all datapages

You can reset the datapages in the data application to the factory defaults.

1. Select **Menu**.
2. Select **Reset All Pages**.
The confirm reset pop up message is displayed.
3. Select **Yes** to reset or **No** to cancel the action.

Note: Resetting all pages will restore your pre-configured pages to default settings and remove any custom pages that have been created. Number of engines and maximum RPM settings will not be changed during the reset.

Chapter 21: Radar application

Chapter contents

- 21.1 Radar application overview and features on page 302
- 21.2 Multiple radar scanners on page 304
- 21.3 Radar scanner status symbols on page 304
- 21.4 Radar context menu on page 306
- 21.5 Radar range and image quality on page 306
- 21.6 Target tracking on page 309
- 21.7 Distances, range, and bearing on page 312
- 21.8 Radar mode and orientation on page 315
- 21.9 Radar presentation menu options on page 317
- 21.10  Radar tuning: On-screen gain controls on page 320
- 21.11 HD and SuperHD radar adjustments on page 321
- 21.12 Non-HD digital radomes adjustments on page 323
- 21.13 Dual range radar operation on page 325
- 21.14 Radar scan speed on page 326
- 21.15 Radar Set-up menu on page 327
- 21.16 Resetting the radar on page 329

21.1 Radar application overview and features

Radio Detection And Ranging (RADAR) is used to detect the presence, distance and speed of objects (known as 'targets'). Radar works by transmitting radio pulses, then detecting reflections of these pulses (echoes) from objects in the area and displaying the reflections as targets on your display.

Important: Until you are familiar with interpreting the radar display; every opportunity should be taken to compare the radar screen patterns with visual targets such as other vessels, buoys and coastal structures. You should practise harbor and coastal navigation during daylight hours and in clear weather conditions.

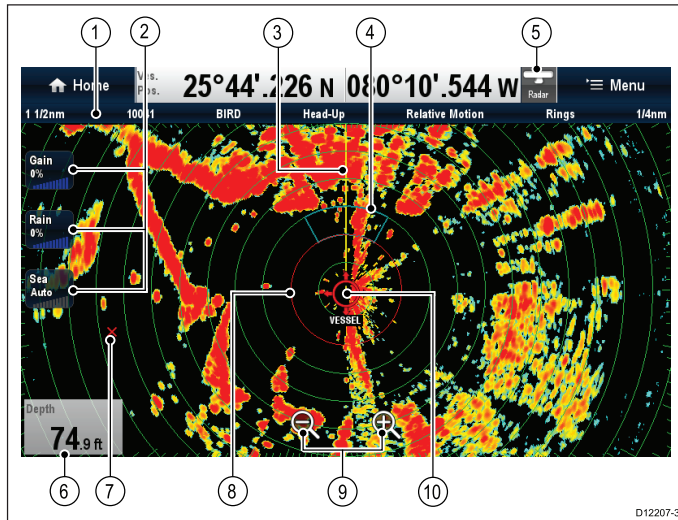

	Description
1	Radar status bar. The status bar displays the following information: <ul style="list-style-type: none"> • Range • Radar scanner serial number • Gain mode • Orientation • Motion mode • Range ring spacing
2	Onscreen controls (Touchscreen multifunction displays only.)
3	Ship's Heading Marker (SHM)
4	Guard Zone
5	Radar status
6	Databox overlay
7	Waypoint
8	Safe zone ring
9	Range controls (Touchscreen multifunction displays only.)
10	Ship's position

Additional functionality of the Radar application includes:

- Color palettes.
- Adding AIS overlay.
- MARPA targets.
- VRM/EBL markers

Typically, your vessel's position is at the center of the display, and its dead ahead bearing is indicated by a vertical heading line, known as the Ship's Heading Marker (SHM).

Note: If the cursor is placed over the SHM, the SHM will temporarily be removed to help placing markers or acquiring targets etc.

Onscreen targets may be large, small, bright or faint, depending on the size of the object, its orientation and surface. If using a non-HD digital radome scanner, strongest target returns are displayed in yellow with weaker returns in 2 shades of blue. If using a HD or SuperHD radar scanner, stronger target returns show as different colors from a range of 256 colors, providing better clarity.

Note: Colors stated above refer to the default color palette.

Be aware that the size of a target on screen is dependent on many factors and may not necessarily be proportional to its physical size. Nearby objects may appear to be the same size as distant larger objects.

With experience, the approximate size of different objects can be determined by the relative size and brightness of the echoes.

You should bear in mind that the size of each onscreen target is affected by:

- The physical size of the reflecting object.
- The material from which the object is made. Metallic surfaces reflect signals better than non-metallic surfaces.
- Vertical objects such as cliffs reflect signals better than sloping objects such as sandbanks.
- High coastlines and mountainous coastal regions can be observed at longer radar ranges. Therefore, the first sight of land may be a mountain several miles inland from the coastline. Although the coastline may be much nearer, it may not appear on the radar until the vessel is closer to shore.
- Some targets, such as buoys and small vessels difficult to discern, because they do not present a consistent reflecting surface as they bob and toss about in the waves. Consequently these echoes tend to fade and brighten, and at times disappear momentarily.
- Buoys and small vessels resemble each other, but vessels can often be distinguished by their motion.

Note: A GPS receiver and a fast heading sensor are required for MARPA operation, and to enable radar/chart overlay.

Radar application Features

Depending on the connected radar scanner different options will be available.	<ul style="list-style-type: none"> • Radar Features
Supports up to 2 radar scanners connected simultaneously.	<ul style="list-style-type: none"> • 21.2 Multiple radar scanners
Tracking targets.	<ul style="list-style-type: none"> • 21.6 Target tracking
Determining target distance, range and bearing.	<ul style="list-style-type: none"> • 21.7 Distances, range, and bearing
Using waypoints to mark the location of targets.	<ul style="list-style-type: none"> • Waypoints in the radar application
Changing the radar display mode and orientation.	<ul style="list-style-type: none"> • 21.8 Radar mode and orientation

HD and SuperHD radar

Your multifunction display can be used with radar scanners.

HD and SuperHD radar scanners provide a range of advantages, making it easier to discern objects around your vessel.

HD and SuperHD radar scanners provide:

- Improved target detection.
- Full-color image.
- Dual Range operation.
- SuperHD option. This effectively increases the transmitter power by a factor of at least 2, and reduces the beamwidth by a similar amount.

Note: You must connect a SuperHD radar scanner in order to use the SuperHD option.

Radar Features

Depending on the type of Raymarine radar you have different features will be available to you, the table below shows which features and settings are supported by radar type:

Feature	Non-HD Digital Radome	HD Radome	HD Open Array	SuperHD Open Array
Color Gain	✗	Auto / Manual (0-100%)	Auto / Manual (0-100%)	Auto / Manual (0-100%)
FTC	Off/On (0-100%)	✗	✗	✗
Sea	Harbour / Coastal / Offshore / Manual (0-100%)	Auto / Manual (0-100%)	Auto / Manual (0-100%)	Auto / Manual (0-100%)
Auto Mode: Buoy	✗	✓	✓	✓
Auto Mode: Harbor	✗	✓	✓	✓

Feature	Non-HD Digital Radome	HD Radome	HD Open Array	SuperHD Open Array
Auto Mode: Offshore	✗	✓	✓	✓
Auto Mode: Coastal	✗	✓	✓	✓
Auto Mode: Bird	✗	✓	✗	✓
Power Boost	✗	✗	✗	✓
Antenna Boost	✗	✗	✗	✓
Interference Rejection	Off / Normal / High	Off / On	Off / On	Off / On
Target Expansion	Off / Low / High	Off / On	Off / On	Off / On
MARPA Targets	10	25	25	25
Dual Range	✗	✓	✓	✓
Dual Range Restrictions	N/A	✗	✗	✗
Scanner Speed	24 RPM	24 RPM / Auto	24 RPM / Auto	24 RPM / Auto
Parking Offset	✗	✗	0-360 degrees	0-360 degrees
Antenna Size	✗	✗	4ft / 6ft	4ft / 6ft
Display Timing	0-153.6m	0-767m (range dependant)	0-767m (range dependant)	0-767m (range dependant)
STC Preset	0-100%	✗	✗	✗
Gain Preset	0-100	✗	✗	✗
Tune Correction	✗	✓	✓	✓

Note: Features not listed are supported by all types of Raymarine Non-HD Digital, HD and SuperHD radars.

21.2 Multiple radar scanners

The multifunction display supports the use of up to 2 radar scanners on the same network.

For each radar application you can select which radar scanner is displayed. 2 radar scanners can be displayed simultaneously by creating a dual splitscreen radar page on the Homescreen.

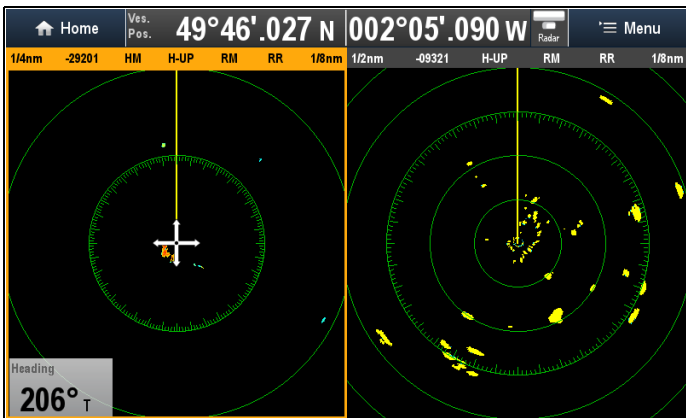

Selecting a radar scanner

On systems with 2 radar scanners, you can select which radar scanner is displayed in each radar application.

From the Radar application:

1. Select **Menu**.
2. Select **Select Radar** option.
3. Select the radar scanner that you want to display in the current radar application.

The radar selection will be remembered by the application and will be displayed automatically the next time that application page is displayed.

21.3 Radar scanner status symbols

The radar scanner power mode status is indicated in the databar.

Symbol	Radar power mode	Description
	Transmit (TX)	Rotating icon, signifying that the scanner is on and transmitting. When SCANNER is set to ON, select this mode to activate the scanner. This is the usual mode of operation.
	Standby (STBY)	Static icon, indicating that the scanner is on but not transmitting, and the antenna is not rotating. The scanner does not transmit and the radar data is removed from the screen. This is a power-save mode used when the radar is not needed for short time periods. When you return to transmit mode, the magnetron does not need to warm up again. This is the default mode.
	Off	Scanner powered off when radar not required, but display is in use for other applications, such as the chart. When selected, the system counts down. During this time you cannot re-power the scanner.
 	Timed Transmit	Scanner switches between on/transmitting, and standby mode. Scanner goes into power save mode when constant use of radar is not required.

Powering on the radar scanner

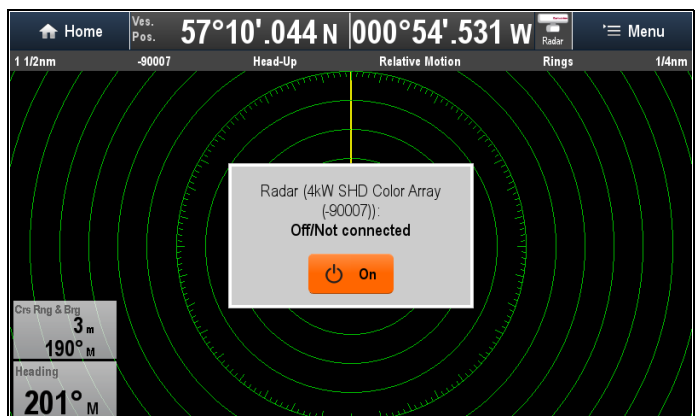

From the Radar application, with the Radar scanner powered off:

1. Select **On** from the onscreen .
The Radar scanner will power up in Standby mode.

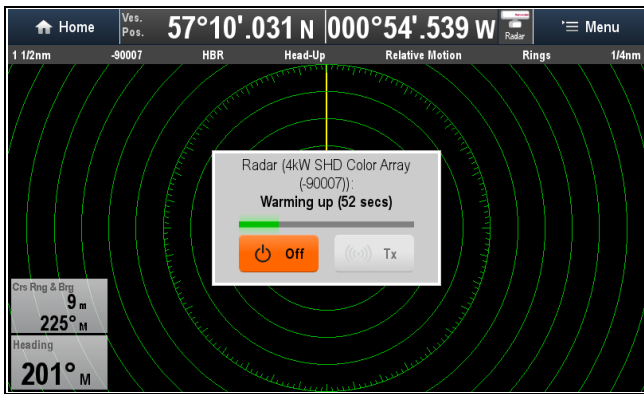

3. Select **Transmit** to start the radar transmitting, or **Standby** to stop the radar transmitting.

2. Once the Radar has powered up, select **Tx** to start the Radar transmitting.

Putting the Radar into Standby

The Radar can be placed into Standby mode, which allows the Radar to remain powered up but not transmitting.

With the Radar transmitting, from the Radar application:

1. Select **Menu**.
2. Select **Radar**: so that Standby is selected.

Powering down the Radar scanner

When the Radar is powered up it can be powered down using the Radar application menu.

With the Radar powered up, from the Radar application

1. Select **Menu**.
2. Select **Power down radar**.

Using the power button to switch operating modes

The radar operating modes can also be set using the multifunction displays shortcut page.

1. Press and release the **Power** button.

If you have 2 radar scanners connected; options for each radar scanner will be shown.

The shortcuts page is displayed:



2. Select **Power up radar(s)** to turn on connected radars, or **Power down Radar** to turn off the selected radar.

Selecting **Power up radar(s)** will power up all radars connected to the network.

21.4 Radar context menu

The radar application includes a context menu which provides positional data and menu items.



The context menu provides the following positional data for the cursor location in relation to your vessel:

- Latitude
- Longitude
- Range
- Bearing

The context menu also provide the following menu items:

- **Acquire Target**
- **Place VRM/EBL**
- **Place Waypoint At Cursor**
- **Slew thermal camera** (Only available when thermal camera is connected and operating.)

Accessing the context menu

You can access the context menu by following the steps below.

1. Non-touchscreen and HybridTouch displays:
 - i. Selecting a location, object or target on-screen and pressing the **Ok** button.
2. HybridTouch and Touch only displays:
 - i. Selecting an object or target on-screen.
 - ii. Selecting and holding on a location on-screen.

21.5 Radar range and image quality

Radar image quality

A number of factors can affect the quality of a radar image, including echoes, sea clutter, and other interference.

Not all radar echoes are produced by valid targets. Spurious or missing echoes may be caused by:

- Side lobes.
- Indirect echoes.
- Multiple echoes.
- Blind sectors.
- Sea, rain, or snow clutter.
- Interference.

Through observation, practice, and experience, you can generally detect these conditions very quickly and use the radar controls to minimize them.

Side Lobes

Side lobe patterns are produced by small amounts of energy from the transmitted pulses that are radiated outside the narrow main beam. The effects of side lobes are most noticeable with targets at short ranges (normally below 3 nm), and in particular with larger objects. Side lobe echoes form either arcs on the radar screen similar to range rings, or a series of echoes forming a broken arc.

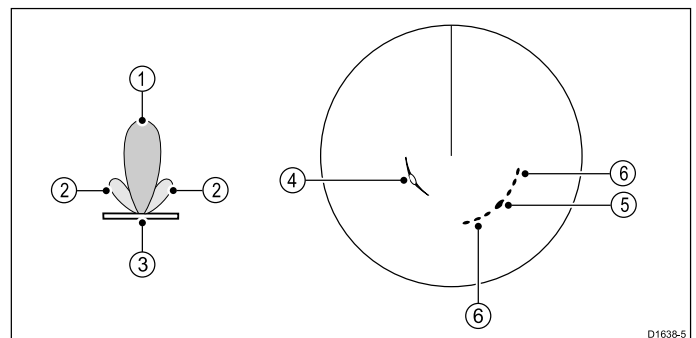

Item	Description
1	Main lobe
2	Side lobes
3	Antenna
4	Arc
5	True echo
6	Side echoes

Indirect Echoes

There are several types of indirect echoes or ghost images. These sometimes have the appearance of true echoes, but in general they are intermittent and poorly defined.

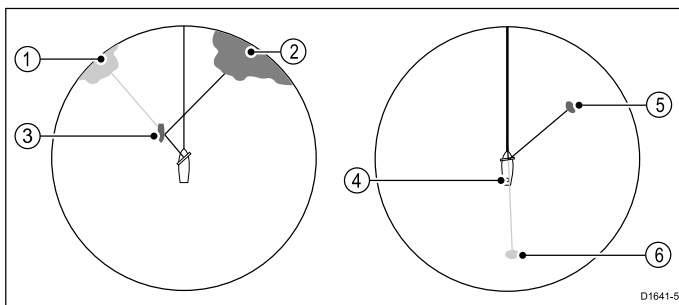

Item	Description
1	False echo
2	True echo
3	Passing ship
4	Mast or funnel
5	True echo
6	False echo

Multiple Echoes

Multiple echoes are not very common but can occur if there is a large target with a wide vertical surface at a comparatively short range. The transmitted signal will be reflected back and forth between the target and your own ship, resulting in multiple echoes, displayed beyond the range of the true target echo, but on the same bearing.

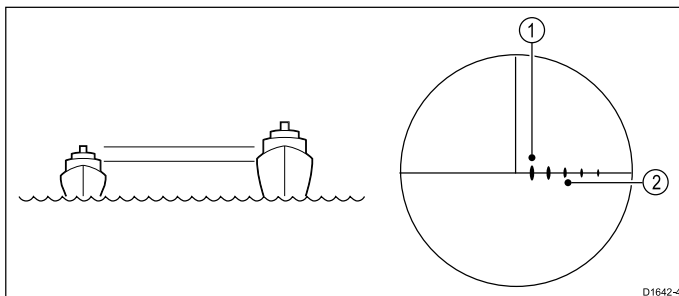

Item	Description
1	True echo
2	Multiple echoes

Blind Sectors

Obstructions such as funnels and masts near the radar antenna may obstruct the radar beam and cause radar shadows or 'blind sectors'. If the obstruction is relatively narrow, there will be a reduction of the beam intensity, though not necessarily a complete cut-off. However, for wider obstructions there may be a total loss of signal in the shadow area. There may also be multiple echoes which extend behind the obstruction. Blind sector effects can normally be minimized by careful selection of the scanner site prior to installation.

Rain or Snow Clutter

The radar can see echoes from rain or snow. Returns from storm areas and rain squalls consist of countless small echoes that continuously change size, intensity and position. These returns sometimes appear as large hazy areas, depending

on the intensity of the rainfall or snow in the storm cell. The images in the table below show how the Rain control can clear up this clutter:

Rain clutter off	
Rain clutter on	

Sea Clutter

Radar returns from waves around the vessel can clutter the centre of the radar picture, making it difficult to detect real targets. Such 'sea clutter' usually appears as multiple echoes on the display at short range scales, and the echoes are not repetitive or consistent in position. With high winds and extreme conditions, echoes from sea clutter may cause dense background clutter in the shape of an almost solid disc. Sea clutter can be suppressed using the sea clutter settings. The images in the table below show how the sea clutter settings can clear up some of this clutter:

Sea clutter off	
Sea clutter in auto	

Interference

When two or more radar-equipped vessels are operating within range of each other mutual radar interference can occur. This usually appears as a spiral of small dots from the display centre. This type of interference is most noticeable at long ranges. This interference can be suppressed using the interference rejection settings. The images in the table below show how the Interference rejection settings can clear up some of this interference:

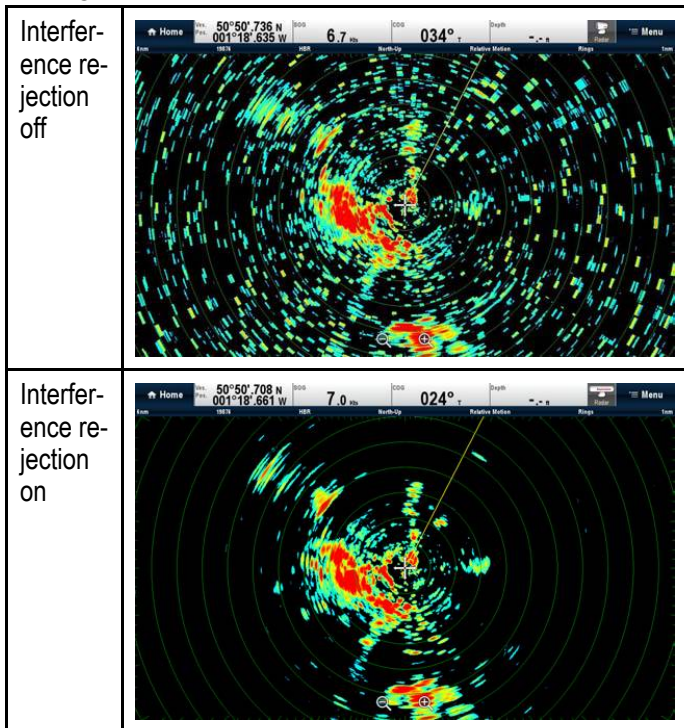

The table below shows typical maximum radar ranges for various radar antenna heights and target heights. Remember that although the radar horizon is greater than the optical horizon, the radar can only detect targets if a large enough target is above the radar horizon.

Antenna height (meters)	Target height (meters)	Maximum range (Nautical miles)
3	3	7.7
3	10	10.9
5	3	8.8
5	10	12

Maximum radar range

The usable range of the radar is limited by factors such as the height of the scanner, and height of the target.

Maximum radar range is essentially line-of-sight, so is limited by the height of the scanner and the height of the target as illustrated below:

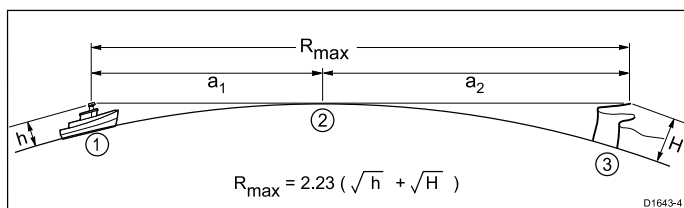

Item	Description
1	Radar equipped vessel.
2	Curvature of the earth.
3	Target (Cliff).
a_1	Radar horizon of antenna.
a_2	Radar horizon of target.
R_{\max}	Maximum radar range in nautical miles. $R_{\max} = a_1 + a_2$
h	Radar antenna height in metres.
H	Target height in metres.

21.6 Target tracking

The **Guard Zone**, **VRM/EBL** and **MARPA** functions will help you track targets and avoid collisions.

With a radar connected to your multifunction display, you can:

- Assess how far away a target is and its bearing (VRM/EBL).
- Set an alarm to trigger when a target is within a specified zone (Guard Zone).
- Display detailed information on tracked targets (MARPA).
- Display the range and bearing of a target.

Setting up a radar guard zone

From the radar application:

1. Select **Menu**.
2. Select **Zones**.
3. Select **Guard Zone** so that On is highlighted. Selecting Guard Zone will switch the zone On and Off.
4. Select **Guard Zone Set-up**.
5. Select **Shape**: to switch between Sector or Circle.
6. Select **Outer**: . The Outer numeric adjust control is displayed.
7. Adjust the outer edge of the guard zone to the required distance.
8. Select **Ok** to close the numeric adjust control.
9. Select **Inner**: . The Inner numeric adjust control is displayed.
10. Adjust the inner edge of the guard zone to the required distance.
11. Select **Ok** to close the numeric adjust control.
12. Select **Width**: . The Width numeric adjust control is displayed.
13. Adjust the width of the guard zone in degrees.
14. Select **Ok** to close the numeric adjust control.
15. Select **Bearing**: . The Bearing numeric adjust control is displayed.
16. Adjust the bearing of the guard zone in degrees port or degrees starboard.
17. Select **Ok** to close the numeric adjust control.

Note: Guard zone width and bearing can only be adjusted when the **Shape**: is set to Sector.

Guard zone context menu

The guard zone function includes a context menu which provides additional menu items.

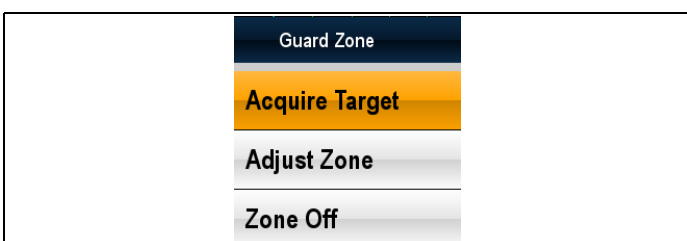

Radar application

The context menu provides the following menu items:

- **Acquire Target**.
- **Adjust Zone**
- **Zone Off**

Accessing the context menu

You can access the context menu by following the steps below.

1. Non-touchscreen and HybridTouch displays:
 - i. Selecting a location, object or target on-screen and pressing the **Ok** button.
2. HybridTouch and Touch only displays:
 - i. Selecting an object or target on-screen.
 - ii. Selecting and holding on a location on-screen.

Adjusting guard zone sensitivity

You can adjust the threshold at which the alarm is triggered by a target entering the guard zone.

From the Radar application menu:

1. Select **Zones**.
2. Select **Sensitivity**. The sensitivity numeric adjust control is displayed.
3. Adjust the sensitivity to the required value.
4. Select **Ok** or **Back** to confirm setting and close the numeric adjust control.

MARPA overview

MARPA is used for target tracking and risk analysis in the radar application.

With an accurate heading sensor connected to your multifunction display, you can use the Mini Automatic Radar Plotting Aid (MARPA) functions for target tracking and risk analysis. MARPA improves collision avoidance by calculating information for tracked targets, and provides continuous, accurate, and rapid situation evaluation. The number of targets that you can track at any one time is dependent on the model of radar scanner that you are using.

MARPA tracks acquired targets, and calculates the target's speed and course.

Each target tracked can be displayed with a graphic indicating the Closest Point of Approach (CPA), and Time to Closest Point of Approach (TCPA). The calculated target data can also be shown on your screen. Each target is continually assessed and an audible alarm is sounded if a target becomes dangerous, or is lost.

For effective MARPA operation, your multifunction display must have accurate heading and speed data for your vessel. The better the quality of the heading and speed data, the better MARPA will perform. For the best heading data, a Raymarine SMART heading sensor or a gyro-stabilized autopilot is required.

In True Motion mode, Speed Over Ground (SOG) and Course Over Ground (COG) information is required to show true target course and speed.

In Relative Motion mode, heading and speed information is required.

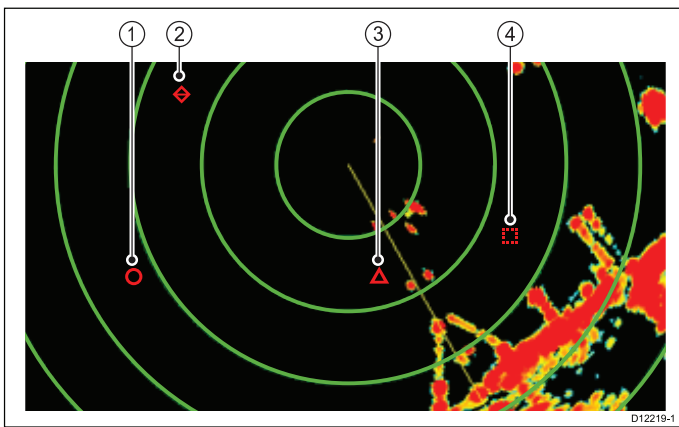

Item	Description
1	Safe target
2	Lost target
3	Dangerous target
4	Target being acquired

Safety notices

MARPA can improve collision avoidance when used wisely. It is your responsibility to exercise common prudence and navigational judgement.

There are conditions where acquiring a target may become difficult. These same conditions may be a factor in successfully tracking a target. Some of the conditions are:

- The target echo is weak. The target is very close to land, buoys or other large targets.
- The target or your own vessel is making rapid manoeuvres.
- Choppy sea state conditions exist and the target is buried in excessive sea clutter or in deep swells.
- Choppy sea state conditions exist yielding poor stability; own vessel's heading data is very unstable.
- Inadequate heading data.

Symptoms of such conditions include:

- target acquisition is difficult and the MARPA vectors are unstable;
- the symbol wanders away from the target, locks-on to another target, or changes to a lost symbol target.

In these circumstances, target acquisition and tracking may need to be re-initiated and in some cases might be impossible to maintain. Better quality heading data might improve performance in these circumstances.

How a MARPA risk is assessed

Each target is monitored to ascertain whether it will be within a certain distance from your vessel within a certain time. If so, the target is designated as dangerous, and an audible warning is sounded and a warning displayed. The target symbol changes to the dangerous target symbol and flashes to indicate that it is a dangerous target. Acknowledging the alarm will remove the warning.

If a target is lost, either because the MARPA software has lost contact with it, or because it has moved out of range, an audible alarm is sounded and an on-screen warning appears. The on-screen symbol will change to the target lost symbol. Acknowledging the warning will silence the alarm and remove the on-screen warning and the target lost symbol.

Effective range for MARPA targets

MARPA target acquisition is only available at radar range scales of up to 12 nm, although tracking continues at all ranges.

If you change to a smaller range scale, targets may be beyond the range of your radar scanner and will be lost. In such cases, an on-screen warning indicates that the target is off-screen.

MARPA context menu

The MARPA function includes a context menu which provides positional data and menu items.

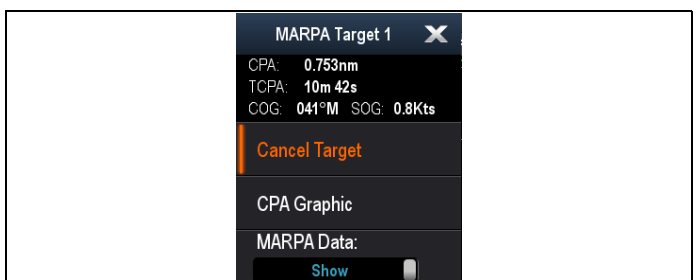

The context menu provides the following target information:

- CPA
- TCPA
- COG
- SOG

The context menu also provide the following menu items:

- **Cancel target**
- **CPA Graphic**
- **MARPA Data**
- **Slew thermal camera** (Only available when thermal camera is connected and operating.)

Accessing the context menu

You can access the context menu by following the steps below.

1. Non-touchscreen and HybridTouch displays:
 - i. Selecting a location, object or target on-screen and pressing the **Ok** button.
2. HybridTouch and Touch only displays:
 - i. Selecting an object or target on-screen.
 - ii. Selecting and holding on a location on-screen.

Configuring target options

From the radar application:

1. Select **Menu**.
2. Select **Targets**.
3. Select **Target Options**.

4. Select **Vector Length**.
5. Select an appropriate time period.
The distance that your vessel travels in the time period you specify here determines the length of the vector lines.
6. Select **Target History**.
7. Select an appropriate time period.
The target's previous position will be plotted on the radar display as a target icon with lighter shading than the actual target.

Note: MARPA and AIS functions share **Safe Zone** and **Vector Length** settings.

Setting up the Safe Zone Ring

You can adjust the Safe Zone Ring radius, the time to Safe Zone and choose whether AIS targets trigger the Safe Zone alarm from the Safe Zone Ring Set-up menu.

The Safe Zone Set-up menu can be accessed as follows:

- From the Radar application: **Menu > Zones > Safe Zone Set-up**.
- From the Chart application with only the AIS overlay enabled: **Menu > AIS Options > Safe Zone > Safe Zone Set-up**.
- From the Chart application with only the Radar overlay enabled: **Menu > Radar Options > Safe Zone > Safe Zone Set-up**.
- From the Chart application with the AIS and Radar overlays enabled: **Menu > Radar & AIS Options > Safe Zone > Safe Zone Set-up**.

From the Safe Zone Set-up menu:

1. Select **Safe Zone Radius**.
 - i. Select the required radius for the safe zone.
2. Select **Time to Safe Zone**.
 - i. Select the required time period.
3. Select **Safezone (AIS targets)** so that On is highlighted.
Selecting Safezone (AIS targets) will switch the dangerous target alarm between On and Off.

Using MARPA

Acquiring a MARPA target to track

From the radar application:

1. Select the target to be acquired.
The MARPA context menu is displayed.
2. Select **Acquire Target**.

The “target being acquired” symbol is displayed. If the target is present for several scans, the radar locks-on to the target, and the symbol changes to “safe target” status.

Cancelling a MARPA target using the MARPA context menu

From the radar application:

1. Select the relevant target.
The MARPA context menu is displayed.
2. Select **Cancel Target** or **Cancel All Targets**.

Cancelling a MARPA target using the menu

1. Select **Menu**.
2. Select **Targets**.
3. Select **View Target Lists**.
4. Select **View MARPA List**.
5. Select the relevant MARPA target from the list.
6. Select **Cancel Target** or **Cancel All Targets**.

Vessel vectors (CPA graphics) overview

CPA graphics show vectors for your vessel and a selected target.

A vector is a line on-screen showing the predicted courses of your vessel and the selected target if you both remain on your present course. These vectors vary in length due to vessel speed and vector length set in the MARPA Set-up menu.

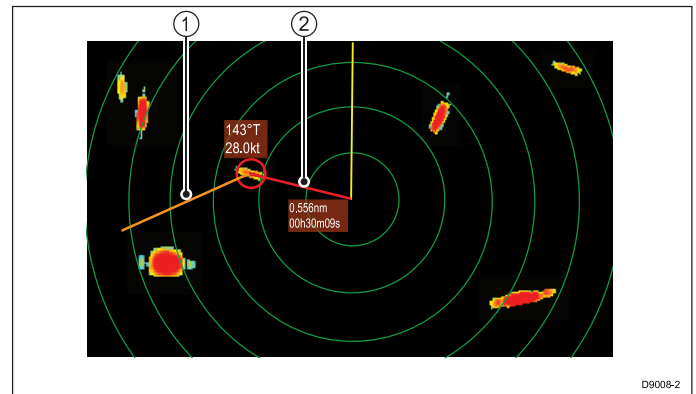

Item	Description
1	Target vector
2	CPA graphic

True motion

With the display set in true motion mode, the vectors of your vessel and the target are shown extended to their intersection point. The CPA is shown as a line that is placed on your vessel's vector at the point of the CPA. The length and direction of the line indicates the distance and bearing of the target at CPA. The text indicates CPA and TCPA. The text next to the target symbol indicates its true course and speed.

Relative motion

With the display set in relative motion mode, no vector extension of your vessel is shown. The CPA line emerges from your own vessel, with the target vector extension being shown as relative, not true. The text next to the target indicates its course and speed.

Displaying MARPA target data

1. Select the target.
The MARPA context menu is displayed which provides the following data:
 - Closest Point of Approach (CPA).
 - Time to Closest Point of Approach (TCPA).
 - COG (if available).
 - SOG (if available).

2. To display CPA graphics select **CPA Graphic** from the context menu:
 - i. Select **Auto** to display the CPA graphic when the target is selected.
 - ii. Select **On** to display the CPA graphic while the target is being tracked.
 - iii. Select **Off** to hide the CPA graphic.
3. To display course and bearing information alongside to the target select **MARPA Data** so that Show is highlighted.
 - i. Selecting MARPA Data will switch between Show and Hide.

Viewing full MARPA target information

From the radar application:

1. Select **Menu**.
2. Select **Targets**.
3. Select **View Target Lists**.
4. Select **View MARPA List**.
5. Select the relevant target.

21.7 Distances, range, and bearing

When you are using the radar application, you can measure distances, ranges and bearings in a variety of ways.

These options are detailed in the table below:

Functions	Distances Between Points	Range From Your Vessel	Bearings
Range Rings	Yes (approximate distance)	Yes (approximate range)	No
Cursor	No	Yes	Yes
Variable Range Markers / Electronic Bearing Lines (VRM/EBL)	No	Yes	Yes
Floating VRM/EBL	Yes	No	Yes

Measuring using the range rings

Use the range rings to gauge the approximate distances between points. Range rings are concentric circles displayed on the screen and centred from your vessel at pre-set distances. The number and spacing of the rings changes as you range in and out.

Examples:

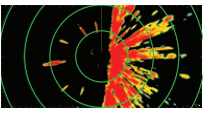
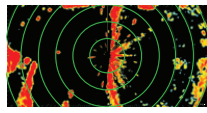
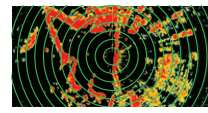
		
Range — 1/4 nm Range Rings — 760ft apart	Range — 3/4 nm Range Rings — 1/4 nm apart	Range — 1 1/2 nm Range Rings — 1/4 nm apart

Measuring using the cursor

To measure the bearing and range from your vessel to a specified target, move the cursor to the appropriate position on the screen and press **Ok**, the radar context menu will be displayed which shall provide:

- Latitude
- Longitude
- Range
- Bearing

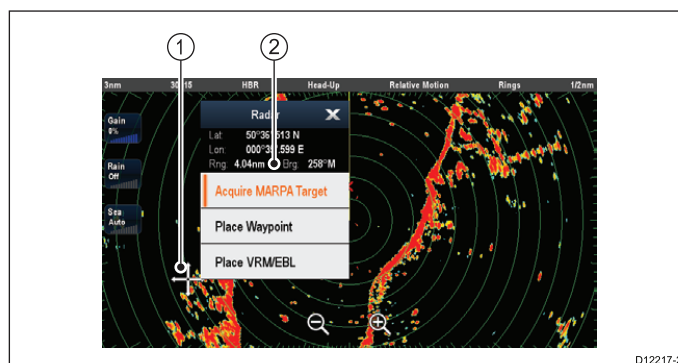

Item	Description
1.	Cursor
2.	Bearing and range from your vessel to the cursor position

You can also display the cursor position in the databar, from the homescreen select: **Customize > Databar Set-up > Edit Databar**, now select the data box where you want the cursor position to be displayed. Select **Navigation > Cursor Position**.

Measuring using VRM/EBL

Variable Range Markers (VRM)

A Variable Range Marker (VRM) is a circle centred on your vessel's position and fixed with respect to the heading mode. When this circle is adjusted to align with a target, its range from your vessel is measured and displayed on the Radar context menu when you select the VRM with the cursor.

Electronic Bearing Lines (EBL)

An Electronic Bearing Line (EBL) is a line drawn from your vessel to the edge of the window. When this line is rotated to align with a target, its bearing relative to your vessel's heading is measured and displayed on the Radar context menu when you select the VRM with the cursor.

The VRM/EBL are combined to measure both the range and the bearing of the specified target.

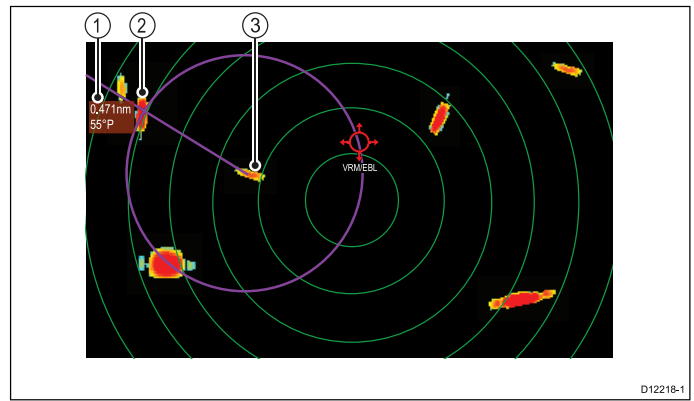

D12218-1

Item	Description
1	Range and bearing
2	Target 1
3	Target 2

VRM/EBL context menu

The VRM/EBL function includes a context menu which provides positional data and menu items.

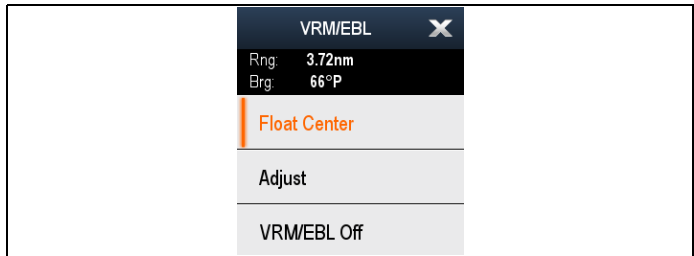

The context menu provides positional data of the VRM/EBL in relation to your vessel:

- Range
- Bearing

The context menu also provide the following menu items:

- **Float Centre**
- **Adjust**
- **VRM/EBL Off**

Accessing the context menu

You can access the context menu by following the steps below.

1. Non-touchscreen and HybridTouch displays:
 - i. Selecting a location, object or target on-screen and pressing the **Ok** button.
2. HybridTouch and Touch only displays:
 - i. Selecting an object or target on-screen.
 - ii. Selecting and holding on a location on-screen.



Creating a VRM/EBL on the radar display

To create a VRM/EBL on a touchscreen multifunction display follow the steps below:

From the radar application:

1. Select and hold on the screen.
The radar context menu is displayed.
2. Select **Place VRM/EBL**.
3. Select the required location / target.
The VRM/EBL is now set at the selected location.

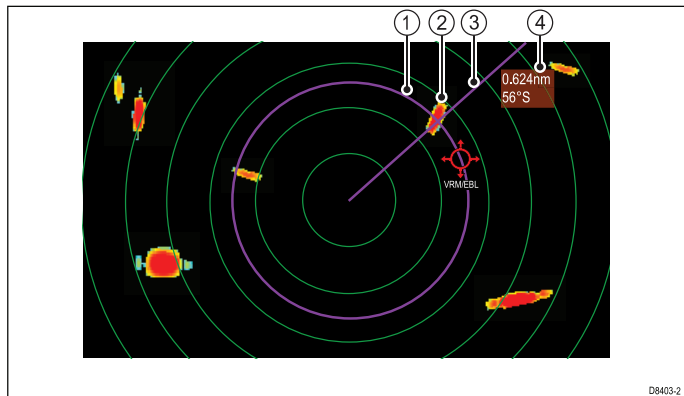

D8403-2

Item	Description
1	VRM
2	Target
3	EBL
4	Range and bearing

Measuring using floating VRM/EBL

You can use the VRM/EBL float function to measure the range and bearing between any two points on the radar screen. This function allows you to move the VRM/EBL centre away from your vessel's position and onto a target. You can then change the radius of the VRM to determine the distance between two points and change the angle of the EBL, relative to its new origin, to obtain the bearing.

Creating a VRM/EBL on the radar display

From the radar application:

1. Select a target or location on screen.
2. Press the **Ok** button.
The radar context menu is displayed.
3. Select **Place VRM/EBL**.
4. Using the **Joystick** adjust the VRM/EBL to the required bearing and range.
5. Press the **Ok** button to save the setting.

Creating a floating VRM/EBL on the radar display

To float a VRM/EBL on a touchscreen multifunction display follow the steps below:

From the radar application with a VRM/EBL already created:

1. Press and hold on the VRM/EBL.
The VRM/EBL context menu is displayed.
2. Select **Float Center**.
3. Select the desired location for the center position.
The VRM/EBL is placed at the new location.

Creating a floating VRM/EBL on the radar display

From the radar application with a VRM/EBL already created:

1. Position the cursor over the VRM/EBL.
2. Press the **Ok** button.
The radar context menu is displayed.
3. Use the **Rotary Control** to select **Float Center**.
4. Press the **Ok** button.
5. Using the **Joystick**, move the center position of the circle to the desired position.
6. Press the **Ok** button to confirm the new position.

Unfloating a VRM/EBL on the radar display

To re-center a VRM/EBL on a touchscreen multifunction display follow the steps below:

From the radar application:

1. Position the cursor over the VRM/EBL.
The Radar context menu is displayed.
2. Select **Center**.

Unfloating a VRM/EBL on the radar display

From the radar application:

1. Position the cursor over the VRM/EBL.
2. Press the **Ok** button.
The VRM/EBL context menu is displayed.
3. Select **Center**.

Using the radar range rings

Radar range rings enable you to measure the distance between two points on the radar display.

Use the range rings to gauge the approximate distances between points. Range rings are concentric circles displayed on the screen and centred from your vessel at pre-set distances. The number and spacing of the rings changes as you range in and out.

Examples:

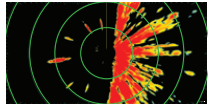
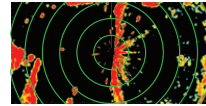
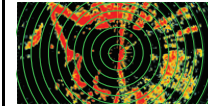
		
Range — 1/4 nm Range Rings — 760ft apart	Range — 3/4 nm Range Rings — 1/4 nm apart	Range — 1 1/2 nm Range Rings — 1/4 nm apart

Enabling and disabling radar range rings

From the radar application:

1. Select **MENU**.
2. Select **Presentation**.
3. Select **Range Rings**.

Selecting Range rings will switch the range rings On and Off.

21.8 Radar mode and orientation

Radar orientation modes

The radar can operate in a number of orientation modes to suit different types of navigation.

The orientation of the radar refers to the relationship between the radar and the direction that you are travelling in. There are three orientation modes to choose from:

- Head-Up
- North-Up
- Course-Up

These orientation modes are used in conjunction with motion mode to control how your boat and radar relate to one another and how they are displayed on screen. Any changes that you make to the orientation of the radar are retained when you switch off your multifunction display.

Head-Up

This is the default mode for the radar application.

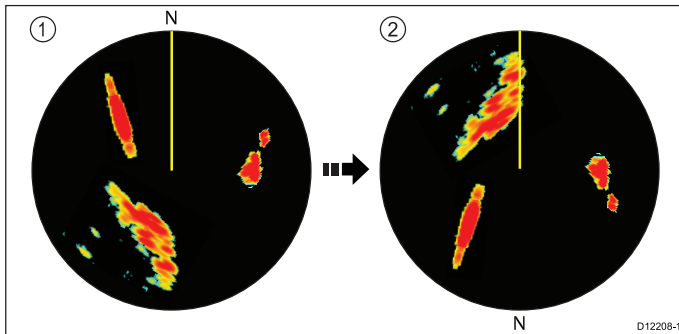

Item	Description
1	Ship's Heading Marker (SHM) (indicating the vessel's current heading is upwards).
2	As the vessel's heading changes: <ul style="list-style-type: none"> • SHM is fixed upwards • Radar picture rotates accordingly

North-Up

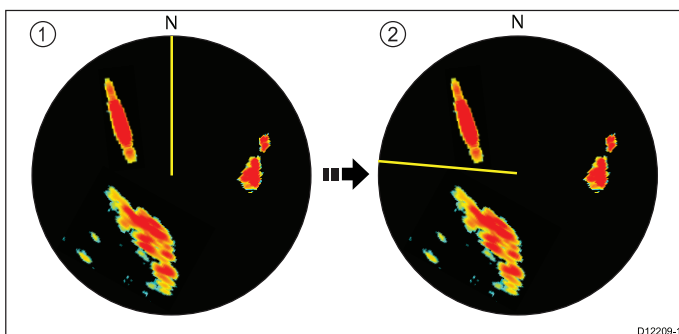

Item	Description
1	True north at top.
2	As your vessel's heading changes: <ul style="list-style-type: none"> • Radar picture is fixed (north up) • SHM rotates accordingly

Note: If heading data becomes unavailable whilst in this mode, a warning message will be shown, the status bar indicates North-Up in brackets and the radar uses 0° heading in relative motion. When heading data becomes available once more, North-Up mode is reinstated.

Note: It is not possible to select Head Up mode when the motion mode is set to True.

Course-Up

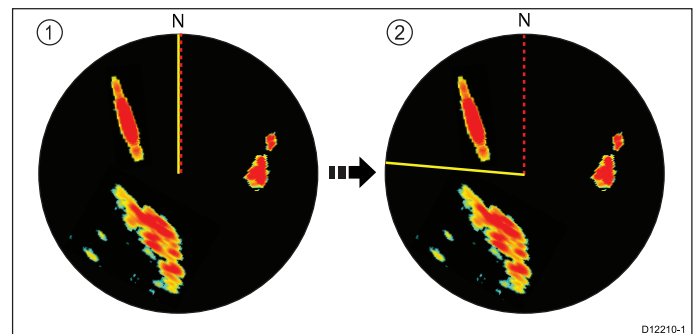

Item	Description
1	Current course upwards.
2	As your vessel's heading changes: <ul style="list-style-type: none"> • Radar picture is fixed • SHM rotates accordingly

If you select a new course, the picture will reset to display the new course upwards.

The reference used for Course-Up depends upon the information available at a given time. The system always prioritizes this information in the following order:

1. Bearing from origin to destination, that is, intended course.
2. Locked heading from an Autopilot.
3. Bearing to waypoint.
4. Instantaneous heading (when course-up is selected).

Note: If heading data becomes unavailable whilst in this mode, a warning message will be shown, the status bar indicates the Course Up in brackets and the radar uses 0° heading in relative motion. When heading data becomes available once more, Course-Up mode is reinstated.

Selecting the radar orientation mode

From the radar application:

1. Select **Menu**.

2. Select **Presentation**.
3. Select **Orientation & Motion Mode**.
4. Select **Orientation**.
5. Select the required orientation.

Radar motion modes overview

The motion mode controls the relationship between the radar and your vessel. There are two modes:

- Relative motion.
- True motion.

The selected motion mode is displayed in the status bar. The default setting is Relative Motion with no offset.

Relative Motion (RM) with optional Vessel Offset

When the motion mode is set to Relative, the position of your vessel is fixed on the screen and all the targets move relative to the vessel. You can specify whether the vessel is fixed in the center of the window, partially offset or fully offset to increase the view ahead, as shown below:

Examples:

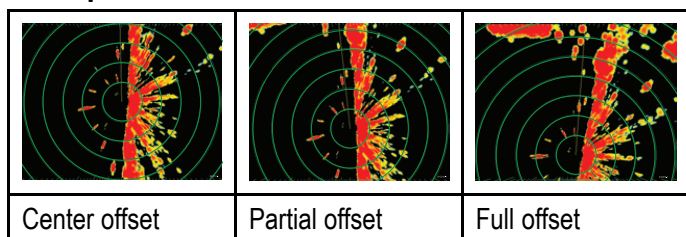

The default motion mode is “Relative”, with center offset.

True Motion (TM)

When the motion mode is set to True, fixed radar targets maintain a constant position and moving vessels (including your vessel) travel in true perspective to each other and to fixed landmasses on the screen. As the vessel’s position approaches the edge of the screen, the radar picture is automatically reset to reveal the area ahead.

Note: If heading and position data become unavailable when True motion is selected, a warning message will be shown, the mode will revert to relative motion and be noted in the status bar in brackets, for example, (TM).

Note: It is not possible to select True Motion when the orientation is set to Head Up.

Selecting the radar motion mode

From the radar application:

1. Select **Menu**.
2. Select **Presentation**.
3. Select **Orientation & Motion Mode**.
4. Select **Motion Mode**.

Selecting Motion Mode will switch between True and Relative.

Changing the radar vessel offset

Radar offset is only available in Relative motion mode.

From the radar application:

1. Select **Menu**.
2. Select **Presentation**.
3. Select **Orientation & Motion Mode**.
4. Select **Boat Offset**.
5. Select the required offset value.

21.9 Radar presentation menu options

Function	Description	Options
Dual Range	This menu item allows you to turn Dual range mode On and Off.	<ul style="list-style-type: none"> • On • Off
Dual Range Channel	This menu item allows you to choose long or short channel for dual range.	<ul style="list-style-type: none"> • 1 • 2
Orientation & Motion Mode	<p>This menu item contains a sub-menu which enables you to adjust the orientation and motion mode:</p> <ul style="list-style-type: none"> • Orientation • Motion Mode • Boat Offset 	<p>Orientation</p> <ul style="list-style-type: none"> • Head Up • North Up • Course Up <p>Motion Mode</p> <ul style="list-style-type: none"> • True • Relative <p>Boat Offset</p> <ul style="list-style-type: none"> • Center (default) • Partial Offset • Full Offset
Select Waypoints to Display	This menu item takes you to the Display Waypoints dialog where you can choose which waypoint icons to Show/Hide in the radar application.	<p>Display Waypoint</p> <ul style="list-style-type: none"> • Show • Hide
Waypoint Name	This menu item allows you to show or hide waypoint names in the radar application.	<ul style="list-style-type: none"> • Show • Hide
Enhance Echoes	<p>This menu item contains a sub-menu which enable you to adjust the follow options:</p> <ul style="list-style-type: none"> • Interference Rejection • IR Level — only available on non-HD digital radomes. • Expansion • Expansion Level — only available on non-HD digital radomes. • Wakes • Wakes Period 	<p>Interference Rejection</p> <ul style="list-style-type: none"> • On • Off <p>IR Level — only available on non-HD digital radomes.</p> <ul style="list-style-type: none"> • Normal • High <p>Expansion</p> <ul style="list-style-type: none"> • On • Off <p>Expansion Level — only available on non-HD digital radomes.</p> <ul style="list-style-type: none"> • Low • High <p>Wakes</p> <ul style="list-style-type: none"> • On • Off <p>Wakes Time Period</p> <ul style="list-style-type: none"> • 10 Secs • 30 Secs • 1 Min

Function	Description	Options
		<ul style="list-style-type: none"> • 5 Min • 10 Min
Color Palette	This menu item allows you to select a Color Palette for the radar application.	<ul style="list-style-type: none"> • Bold • Professional 1 • Professional 2 • Classic • Night Vision
Range Rings	This menu item allows you to turn the range rings On and Off.	<ul style="list-style-type: none"> • On • Off
Safe Zone Ring	This item allows you to show or hid the safe zone ring in the radar application.	<ul style="list-style-type: none"> • Show • Hide
Gain Controls	This item allows you to show or hide the onscreen gain controls on multifunction displays with a touchscreen.	<ul style="list-style-type: none"> • Show • Hide
Databoxes	<p>This menu item contains a sub-menu which enables you to turn on and select information to display in data cells located on the bottom left of the radar application (Data cells will be displayed in all radar windows).</p> <ul style="list-style-type: none"> • Databox 1 • Select Data • Databox 2 • Select Data 	<p>Databox 1 & 2</p> <ul style="list-style-type: none"> • On • Off <p>Select Data</p> <ul style="list-style-type: none"> • List of available data by category

Enhance echoes functions

Enabling radar interference rejection

From the radar application:

1. Select **Menu**.
2. Select **Presentation**.
3. Select **Enhance Echoes**.
4. Select **Interference Rejection** so that On is highlighted.
Selecting Interference Rejection will switch the function between On and Off.
5. For non-HD digital radomes you can also select an interference rejection level:
 - i. Select **IR Level**.
Selecting IR Level will switch between Normal and High.

Enabling radar expansion

From the radar application:

1. Select **Menu**.
2. Select **Presentation**.
3. Select **Enhance Echoes**.
4. Select **Expansion** so that On is highlighted.
Selecting expansion will switch the function between On and Off.
5. For non-HD digital radomes you can also select an interference rejection level
 - i. Select **Expansion Level**.
Selecting Expansion Level will switch between Low and High.

Radar wakes (Trails)

Radar wakes enable you to see target history. Wakes will appear differently depending on whether your radar is set to True motion or Relative motion mode.

Relative motion mode

In relative motion mode radar wakes appear on targets that are moving relative to the sea (Sea stabilized) this includes targets that are fixed to the ground, such as piles.

Wakes do not appear if a target is moving at the same speed and in the same direction as your vessel.

Relative motion mode example

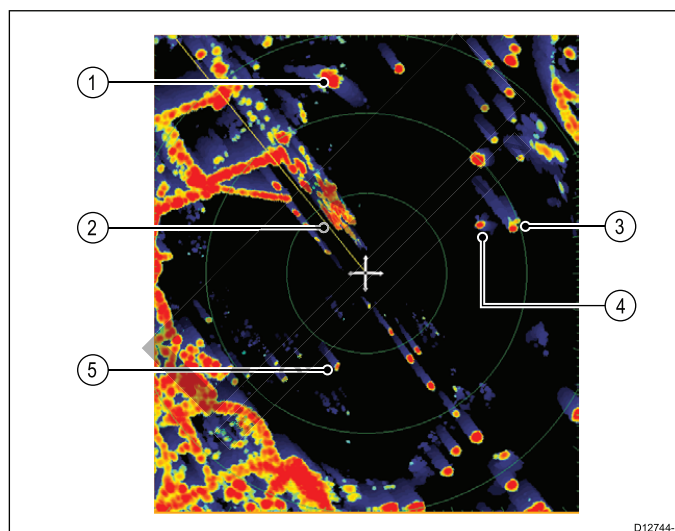

1	Target moving faster and in the same direction as vessel (Wake appears towards your vessel's heading).
2	Ships heading marker.
3	Target moving in opposite direction to vessel (Wake appears opposite to your vessel's heading).
4	Target moving at approximately the same speed and direction as vessel (Minimal to no wake).
5	Fixed target (Wake in opposite direction to your vessel's heading).

- 10 sec
 - 30 sec
 - 1 min
 - 5 min
 - 10 min
6. Select the required time period.

True motion mode

In true motion mode radar wakes appear on targets that are moving relative to the ground.

Wakes do not appear on targets that are fixed to the ground.

True motion mode example

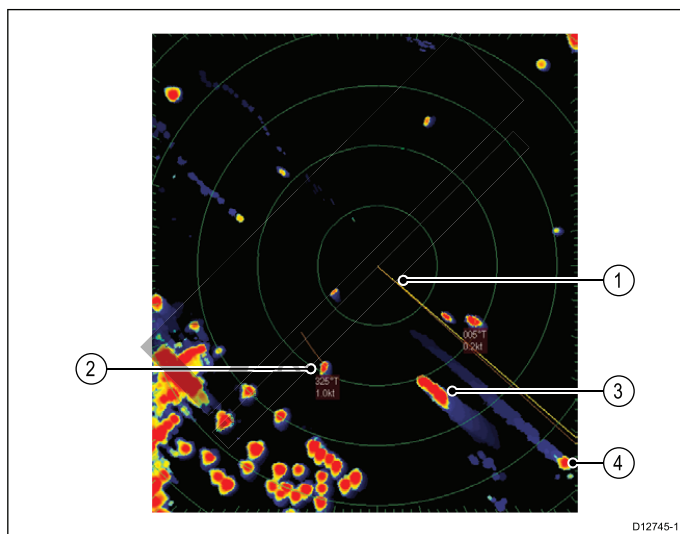

1	Ships heading marker.
2	Target travelling at between 0 kt to 1 kt (Minimal to no wake).
3	Target moving in opposite direction to vessel (Wake appears in opposite direction to your vessel's heading).
4	Target moving in same direction as vessel (Wake appears towards your vessel's heading).

Note: You may see a wake 'ring' around fixed targets due to small error factors such as rotation time delays. This is normal operation.

Enabling radar wakes

From the radar application:

1. Select **Menu**.
2. Select **Presentation**.
3. Select **Enhance Echoes**.
4. Select **Wakes** so that On is highlighted.
Selecting Wakes will switch the function between On and Off.
5. Select **Wakes time period**.
A list of wake time periods is displayed:

21.10 Radar tuning: On-screen gain controls

Touchscreen multifunction displays provide on-screen access to controls for Gain, Rain and Sea clutter.

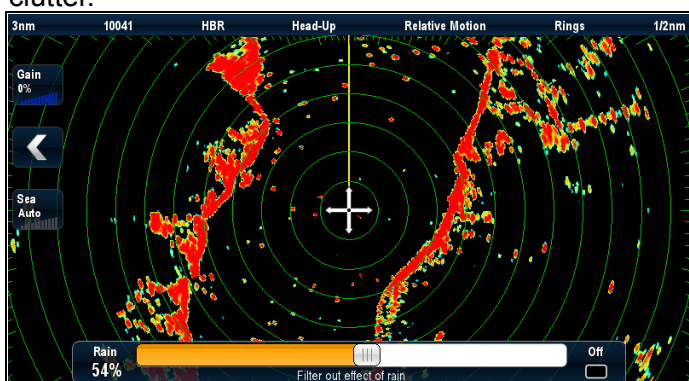

Gain control



Rain control

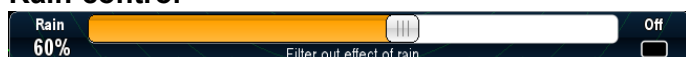

Sea control



Note: non-touchscreen controls are accessed by the menu options: **Menu > Rain** and **Menu > Adjust Gain**.

Enabling and disabling on-screen gain controls

You can enable and disable the on-screen gain controls by following the steps below.

On a touchscreen multifunction display, with the relevant application displayed.

1. Select **Menu**.
2. Select **Presentation**.
3. Select **Gain Controls**.

Selecting Gain Controls will switch between showing and hiding the on-screen controls.

Note: When the on-screen Gain controls are set to Hidden then the Gain settings can be accessed directly from the application menu: **Menu > Gain**.

Using the on-screen gain controls

To adjust settings using the on-screen controls follow the steps below.

On a touchscreen multifunction display, with the radar application displayed:

1. Select either the **Gain**, **Rain** or **Sea** on-screen icon.
The on-screen slider bar control is displayed.
2. Select the **Auto** box (Gain and Sea) or **Off** box (Rain) so that a tick is **placed** in the box to switch to automatic control or switch the control off, or
3. Select the **Auto** box (Gain and Sea) or **Off** box (Rain) so that a tick is **removed** placed in the box to switch to manual control.

4. Adjust the slider bar to the required setting.
5. The slider bar will auto dismiss, or you can select the on-screen icon again to close the slider bar.

21.11 HD and SuperHD radar adjustments

You can use the presets and other functions to improve the quality of the radar picture.

The following settings are available from the Radar menu and apply to HD radomes, HD and SuperHD open array scanners:

Menu Item	Description	Options
Preset Mode	The radar gain presets enable you to quickly select pre-configured settings to achieve the best picture in different situations. Raymarine strongly recommends the use of these presets to achieve optimum results.	<ul style="list-style-type: none"> • Buoy — a special mode that enhances the detection of small objects like mooring buoys. It is useful at ranges up to 0.75 nm. • Harbor — this is the default mode. This setting takes account of land clutter so that smaller targets, like navigation buoys, are not lost. • Coastal — accounts for the slightly higher levels of sea clutter you might encounter out of harbor and adjusts the radar display accordingly. • Offshore — automatically adjusts for high levels of sea clutter. • Bird Mode — a special mode that helps you to identify flocks of birds, useful when identifying suitable fishing locations, for example. <div style="border: 1px solid black; padding: 5px; margin-top: 10px;"> <p>Note: Bird Mode requires a SuperHD open array with software version 3.23 or above or an HD radome.</p> </div>
Rain	The radar scanner detects echoes from rain or snow. These echoes appear on screen as countless small echoes continuously changing size, intensity and position. Turning the rain clutter function On suppresses the bulk effect of rain returns from around your vessel, making it easier to recognize other objects. You can adjust the intensity of this setting between 0 and 100%.	<ul style="list-style-type: none"> • On — enables the Rain function and allows you to adjust the setting between 0 and 100%. • Off — disables the Rain function. This is the default.
Adjust Preset	Each of the gain presets can be manually adjusted using gain, color gain and sea clutter functions.	<ul style="list-style-type: none"> • Gain — enables you to use a preset in automatic mode, or to adjust its gain manually between 0 and 100%. • Color Gain— adjusts the intensity (color) of displayed targets, but does not affect the number of targets displayed. Increasing the color gain causes more targets to be displayed in the same color, which may help you to determine whether an object is an actual target, or just background noise. Reducing the color gain may provide better target detail and detection. • Sea — radar echoes from waves around your vessel can clutter the center of the radar picture, making it difficult to detect real targets. Adjusting the sea gain reduces this clutter for up to 5 nautical miles (depending on wave and sea conditions) from your vessel. • SuperHD Controls — for SuperHD scanners only: <ul style="list-style-type: none"> – Antenna Boost: scales the effective antenna size. At zero, the effective antenna size matches its actual size. At 95%, the effective antenna size is doubled. Increasing the effective antenna size separates targets that appear merged at lower settings. – Power Boost: adjusts effective transmit power. At zero, the radar operates at its standard power (4 kW or 12 kW). At 90, the effective power is increased by a factor of at least two. Increasing the power makes targets more distinct from noise. For maximum benefit, reduce power boost to prevent saturation of strong targets.

Selecting radar presets

These presets require a HD or SuperHD radar scanner. Bird mode requires a SuperHD open array scanner with software version 3.23 or above or an HD radome.

From the Radar application menu:

1. Select **Preset Mode**.
2. Select Buoy, Harbor, Coastal, Offshore, or Bird as appropriate.

Adjusting radar preset gain

Raymarine strongly recommends the use of the preset gain modes to achieve optimum results. However if required manual adjustments can be made.

From the Radar application menu, with the required **Preset Mode** selected:

1. Select **Adjust Preset <Mode>**, where <Mode> shall be the Preset mode already selected.
2. Select **Gain**.
3. The Gain slider bar control is displayed.
4. Adjust the Gain slider bar control to the appropriate setting (between 0 and 100%), or
5. Select the **Auto** box so that a tick is placed in the box for automatic gain control.

Adjusting radar preset color

From the Radar application menu, with the required **Preset Mode** selected:

1. Select **Menu**.
2. Select **Adjust Preset <Mode>**, where <Mode> shall be the Preset mode already selected.
3. Select **Col:**.
4. The Color slider bar control is displayed.
5. Adjust the Color slider bar control to the appropriate setting (between 0 and 100%), or
6. Select the **Auto** box so that a tick is placed in the box for automatic color control.

Adjusting radar anti sea clutter

From the Radar application menu, with the required **Preset Mode** selected:

1. Select **Adjust Preset <Mode>**, where <Mode> shall be the Preset mode already selected.
2. Select **Sea:**.
3. The Sea clutter slider bar control is displayed.
4. Adjust the Sea clutter slider bar control to the appropriate setting (between 0 and 100%), or
5. Select the **Auto** box so that a tick is placed in the box for automatic sea clutter control.

Adjusting radar anti rain clutter

From the radar application:

1. Select **Menu**.
2. Select **Rain**.
The Rain clutter slider bar control is displayed.
3. Adjust the Rain clutter slider bar control to the appropriate setting (between 0% and 100%), or

4. Select the **Off** box so that a tick is placed in the box to turn off anti rain clutter control.

Adjusting SuperHD radar antenna boost

From the Radar application menu:

1. Select **Adjust Preset <Mode>**, where <Mode> shall be the Preset mode already selected.
2. Select **Antenna**.
The Antenna Boost slider bar control is displayed.
3. Adjust the Antenna Boost slider bar control to the appropriate setting (between 0 and 100%), or
4. Select the **Auto** box so that a tick is placed in the box for automatic boost control.

Adjusting SuperHD radar power boost

From the Radar application menu:

1. Select **Adjust Preset <Mode>**, where <Mode> shall be the Preset mode already selected.
2. Select **Power**.
The Power Boost slider bar control is displayed.
3. Adjust the Power Boost slider bar control to the appropriate setting (between 0 and 100%), or
4. Select the **Auto** box so that a tick is placed in the box for automatic boost control.

21.12 Non-HD digital radomes adjustments

You can use the gain presets and other functions to improve the quality of the radar picture.

The following settings apply to non-HD digital radomes and are available from the Radar menu:

Menu Item	Description	Options
Rain	The radar scanner detects echoes from rain or snow. These echoes appear on screen as countless small echoes continuously changing size, intensity and position. Turning the rain clutter function On suppresses the bulk effect of rain returns from around your vessel, making it easier to recognize other objects. You can adjust the intensity of this setting between 0 and 100%.	<ul style="list-style-type: none"> • On — enables the Rain function and allows you to adjust the setting between 0 and 100%. • Off — disables the Rain function. This is the default.
Adjust Preset	<p>Enables you to adjust the sensitivity of the radar reception. In some situations, adjusting the sensitivity may improve the clarity of the radar picture. The following settings are available:</p> <ul style="list-style-type: none"> • Gain • FTC — Enables you to remove areas of clutter at a distance from your vessel. It also helps you to distinguish between two very close echoes on the same bearing, which may otherwise merge and appear as one echo. You can adjust the intensity of the FTC function between 0 and 100%: <ul style="list-style-type: none"> – A higher setting shows only the leading edge of large (rain clutter) echoes, while the effect on smaller (ship) echoes is only slight. – A lower setting reduces background noise and fill-in returns from land and other large targets. • Sea — Enable you to quickly select pre-configured settings to achieve the best picture in different situations. Each of the gain presets has a gain function, which is set to automatic mode by default. Raymarine strongly recommends the use of these presets to achieve optimum results. However, you can adjust this gain manually if required. • Auto Sea Mode 	<p>Gain</p> <ul style="list-style-type: none"> • Auto — the preset operates in automatic mode. This is the default. • Man — allows you to manually adjust the intensity of the gain, from 0 to 100%. <p>FTC</p> <ul style="list-style-type: none"> • On — enables the FTC function and allows you to adjust the setting between 0 and 100%. • Off — disables the FTC function. This is the default. <p>Sea</p> <ul style="list-style-type: none"> • Auto— the preset operates in automatic mode. This is the default. • Man— allows you to manually adjust the intensity of the sea gain, from 0 to 100%. <p>Auto Sea Mode</p> <ul style="list-style-type: none"> • Harbor — this is the default mode. This setting takes account of land clutter so that smaller targets, like navigation buoys, are not lost. • Coastal — accounts for the slightly higher levels of sea clutter you might encounter out of harbor and adjusts the radar display accordingly. • Offshore — Automatically adjusts for high levels of sea clutter.

Adjusting radar anti rain clutter

From the radar application:

1. Select **Menu**.
2. Select **Rain**.
The Rain clutter slider bar control is displayed.
3. Adjust the Rain clutter slider bar control to the appropriate setting (between 0% and 100%), or
4. Select the **Off** box so that a tick is placed in the box to turn off anti rain clutter control.

Adjusting the radar FTC function

From the radar application:

1. Select **Menu**.
2. Select **Adjust Preset <Mode>**, where <Mode> shall be the Preset mode already selected.
3. Select **FTC**.
The FTC slider bar control is displayed.
4. Adjust the FTC slider bar control to the appropriate setting (between 0 and 100%), or

5. Select the **Auto** box so that a tick is placed in the box for automatic FTC control.

Adjusting radar anti sea clutter

From the Radar application menu, with the required **Preset Mode** selected:

1. Select **Adjust Preset <Mode>**, where <Mode> shall be the Preset mode already selected.
2. Select **Sea:** .
3. The Sea clutter slider bar control is displayed.
4. Adjust the Sea clutter slider bar control to the appropriate setting (between 0 and 100%), or
5. Select the **Auto** box so that a tick is placed in the box for automatic sea clutter control.

Selecting radar preset mode

These presets require a digital radar scanner.

From the radar application:

1. Select **Menu**.
2. Select **Preset Mode**.
3. Select Harbor, Coastal or Offshore as appropriate.

21.13 Dual range radar operation

The Dual Range radar function enables you to view 2 ranges at the same time in separate windows. The function is available with SuperHD and HD radar scanners.

Using your multifunction display and an HD or SuperHD radar scanner, you can view either a short or a long range image in separate radar windows.

The default setting is Long, which provides a standard scanner range.

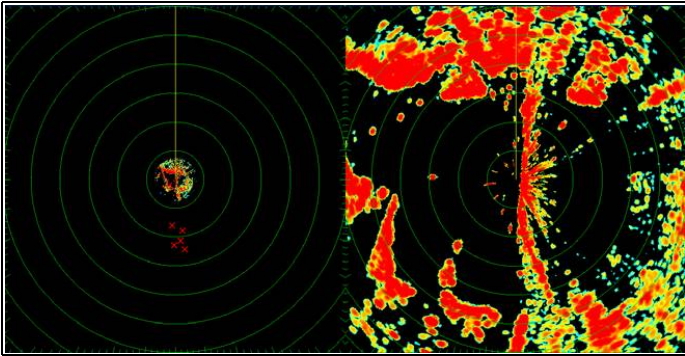

Limitations

- Dual Range operation is not available if MARPA targets are active.
- You cannot acquire MARPA targets if Dual Range is enabled.
- Radar/chart sync and radar/chart overlay are temporarily disabled when Dual Range is enabled.

Dual range radar compatibility

The range covered by the short Dual Range option depends on the radar scanner you are using, and the software version it is using.

Scanner	Dual range mode	*Range covered by software versions 1.xx to 2.xx	Range covered by software versions 3.xx onwards
4 Kw HD Open Array	Long (1)	1/8 nm to 72 nm	1/8 nm to 72 nm
	Short (2)	1/8 nm to 3 nm	1/8 nm to 72 nm
4 Kw SuperHD Open Array	Long (1)	1/8 nm to 72 nm	1/8 nm to 72 nm
	Short (2)	1/8 nm to 3 nm	1/8 nm to 72 nm
12 Kw HD Open Array	Long (1)	n/a	1/8 nm to 72 nm
	Short (2)	n/a	1/8 nm to 72 nm
12 Kw SuperHD Open Array	Long (1)	1/8 nm to 72 nm	1/8 nm to 72 nm
	Short (2)	1/8 nm to 3 nm	1/8 nm to 72 nm

Scanner	Dual range mode	*Range covered by software versions 1.xx to 2.xx	Range covered by software versions 3.xx onwards
HD Radome	Long (1)	1/8 nm to 48 nm	1/8 nm to 48 nm
	Short (2)	1/8 nm to 48 nm	1/8 nm to 48 nm

Limitations of software version 1.xx and 2.xx

- The value for the short range setting must be less than or equal to the long range setting.
- With **Dual Range On** and a short range window active Expansion control shall be disabled in the **Enhance Echoes** menu.

Using Dual Range with SuperHD scanners

Dual range radar operation with SuperHD scanners.

When using the short Dual Range option, a SuperHD scanner operates in HD mode only. When using the long Dual Range option, a SuperHD radar operates in SuperHD mode.

Scanner	Dual Range mode	Operating mode
4 Kw SuperHD Open Array	Long	SuperHD
	Short	HD
12 Kw SuperHD Open Array	Long	SuperHD
	Short	HD

Enabling Dual Range radar operation

In the radar application.

1. Select **Menu**.
2. Select **Presentation**.
3. Select **Dual Range** so that On is highlighted.
Selecting Dual Range will switch between dual range On and Off.

Selecting range operation

With Dual Range set to on and the radar application screen displayed:

1. Select **Menu**.
2. Select **Presentation**.
3. Select **Dual Range Channel** to switch between 1 or 2, as appropriate.

21.14 Radar scan speed

SuperHD open array radars with software version 3.23 or above or HD radomes support multiple scan speeds.

Radar scan speed is set up using the Radar Set-up menu. When the system detects a scanner that is capable of operating at both 24 RPM and 48 RPM, 2 options are provided for scanner speed:

- 24 RPM
- Auto

If you have a radar scanner that only operates at 24 RPM, the scanner speed option is disabled. If the scanner speed option is enabled, you must select the Auto option if you want to use the higher scan speeds. This option automatically switches between the 24 RPM and 48 RPM scan speeds as appropriate.

Selecting radar scan speed

Follow the steps below to change the radar speed.

The speed option requires a 48 RPM compatible Raymarine HD radome or Raymarine SuperHD open array radar scanner.

Select your radar scanner speed from within the radar application.

1. Select **Menu**.
2. Select **Radar Set-up**.
3. Select **Radar Speed**
4. Select the required scanner speed:
 - Auto
 - 24 RPM

The Auto option automatically selects the appropriate speed for your radar range. 48 RPM is used at radar ranges of up to 3 nm. It provides an increased refresh rate, which is useful at high speed or in areas where you have large numbers of radar targets. At radar ranges of greater than 3 nm the display switches the radar speed to 24 RPM.

21.15 Radar Set-up menu

The Radar Set-up menu enables you to configure the performance and behavior of your radar scanner.

Function	Description	Options
Timed Transmit Set-up	<p>This menu item contains a sub-menu that enables you to adjust the timed transmit options:</p> <ul style="list-style-type: none"> • Timed Transmit • Transmit Period • Standby Period 	<p>Timed Transmit</p> <ul style="list-style-type: none"> • On • Off <p>Transmit Period</p> <ul style="list-style-type: none"> • 10 Scans • 20 Scans • 30 Scans <p>Standby Period</p> <ul style="list-style-type: none"> • 3 minutes • 5 minutes • 10 minutes • 15 minutes
Tune Adjust	<p>This menu item allows you to fine tune the radar scanner's receiver for maximum returns on the display. Raymarine recommends that this function is set to Auto. If you set this function to Manual and adjust the setting shortly after powering up the radar scanner, you should adjust it again approximately 10 minutes after powering up the scanner, as the required setting will change after the magnetron has warmed up.</p>	<p>Man</p> <ul style="list-style-type: none"> • Auto • Man 0% — 100%
EBL Reference	<p>The measurement point used for reference when measuring distances using Electronic Bearing Lines (EBLs) and range rings in the chart application. The options are Relative to ships heading or referenced to the compass is degrees Magnetic — True as selected in Bearing Mode.</p>	<ul style="list-style-type: none"> • Relative • Mag-True
Sea Clutter Curve	<p>This menu item allows you to adjust the Sea Clutter — radar echoes from waves can make it difficult to detect real targets. These echoes are known as “sea clutter”. Several factors can affect the level of clutter you see, including the weather and sea conditions, and the mounting height of the radar. The sea clutter curve setting adjusts the radar's sensitivity to sea clutter. The steepest setting for the curve is 1, and the most shallow setting is 8.</p>	<ul style="list-style-type: none"> • Adjust Curve (1 to 8)
Scanner Speed	<p>SuperHD open array radars with software version 3.23 or above or HD radomes support multiple scan speeds:</p> <ul style="list-style-type: none"> • 24 RPM • 48 RPM 	<p>Scanner Speed</p> <ul style="list-style-type: none"> • 24 RPM • Auto — his option automatically switches between the 24 RPM and 48 RPM scan speeds as appropriate.
Advanced	<p>This menu item contains a sub-menu that enables you to adjust the following options:</p> <ul style="list-style-type: none"> • Bearing Alignment • Display Timing • Main Bang Suppression • Tune Preset • STC Preset— Non-HD Digital radomes only • Reset Advanced 	<p>Bearing Alignment</p> <ul style="list-style-type: none"> • -180° — 179.5° <p>Display Timing</p> <ul style="list-style-type: none"> • 0.415 n m — selected range <p>Main Bang Suppression</p> <ul style="list-style-type: none"> • On • Off <p>Tune Preset</p> <ul style="list-style-type: none"> • 0 — 255

Function	Description	Options
		STC Preset <ul style="list-style-type: none"> • 0 — 100% Reset Advanced <ul style="list-style-type: none"> • Yes • No

Adjusting the radar tune control

From the radar application:

1. Select **Menu**.
2. Select **Radar Set-up**.
3. Select **Tune Adjust**.
4. Select **Tune Adjust:** .
The Tune Adjust slider bar control is displayed.
5. Adjust the slider bar control to the appropriate setting, or
6. Select the **Auto** box so that a tick is placed in the box for automatic tuning.

21.16 Resetting the radar

To reset radar settings to defaults follow the steps below:

From in the radar application:

1. Select **Menu**.
2. Select **Radar Set-up**.
3. Select **Advanced**.
4. Select **Reset Advanced**.
A confirmation pop up message is displayed.
5. Select **Yes** to confirm reset.

Chapter 22: Camera application

Chapter contents

- 22.1 Camera application overview and features on page 332
- 22.2 Changing the camera feed on page 333
- 22.3 Displaying multiple camera feeds using Quad View on page 333
- 22.4 Camera cycling on page 334
- 22.5 Naming camera / video feeds on page 335
- 22.6 Adjusting the video image on page 336
- 22.7 Selecting the aspect ratio on page 336
- 22.8 Selecting a location to store recordings on page 337
- 22.9 Record and playback on page 337
- 22.10 Taking photos on page 339
- 22.11 Viewing photos on page 340

22.1 Camera application overview and features

Analog and IP camera and video feeds can be viewed using the Camera application. Analog feeds must be connected directly to the display, IP feeds must be available on the **SeaTalk^{hs}** network. IP camera feeds can be recorded and photos can be taken.

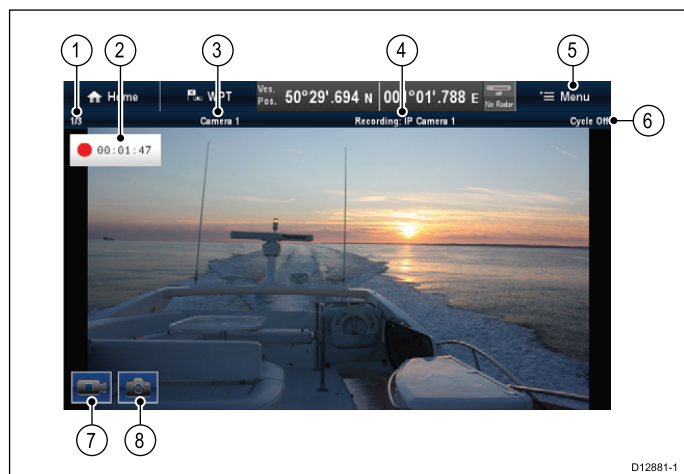

1	Camera feed number – indicates the current feed and number of available feeds
2	Recording status – indicates that the camera application is recording and the current elapsed record time
3	Camera name – indicates the name of the camera that is currently displayed
4	Recording – indicates if the camera application is recording and which feed is being recorded
5	Menu – opens the Camera application's main menu
6	Cycle – indicates if the feed cycling is turned On or Off
7	Record video – temporary onscreen icon to start / stop recording (Touchscreen displays only)
8	Take photo – temporary onscreen icon to take a photo (Touchscreen displays only)

Important:

- Multifunction displays must be powered up before power is applied to networked IP cameras; this is to enable your multifunction display to assign the camera(s) a valid IP address.
- If IP a camera(s) is not detected, try power cycling the camera(s) whilst leaving the multifunction display turned on.

Camera application features

Changing camera or video feeds.	• 22.2 Changing the camera feed
Cycling through available feeds.	• 22.4 Camera cycling
Displaying multiple feeds using Quad View.	• 22.3 Displaying multiple camera feeds using Quad View

Recording IP camera feeds	• 22.9 Record and playback
Playing back recorded footage.	• 22.9 Record and playback
Taking photos of an IP camera feed	• Taking a photo
Viewing images.	• 22.11 Viewing photos

Note: For information on connecting a camera / video source and compatible video formats, refer to [Chapter 4 Cables and connections](#).

22.2 Changing the camera feed



Changing the camera / video feed

On a New a Series or New e Series display, if more than 1 feed is available you can change which feed is displayed on the screen using touch.

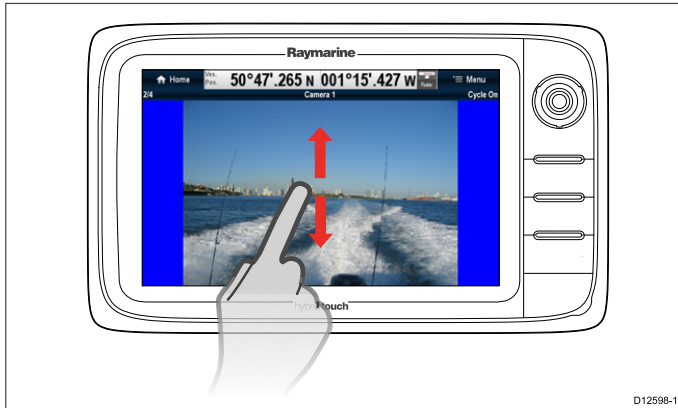

From the Camera application.

1. Touch and swipe your finger up to move to the next video feed.
2. Touch and swipe your finger down to display the previous video feed.



Changing the camera / video feed

On a New c Series or New e Series display, if more than 1 feed is available you can change which feed is displayed on the screen using the Joystick.

From the Camera application

1. Move the **Joystick Down** to display the next video feed.
2. Move the **Joystick Up** to display the previous video feed.

Changing the camera / video feed using the menu

When more than 1 feed is available, you can change which feed is displayed onscreen using the menu.

From the Camera application:

1. Select **Menu**.
2. Select **Camera View**.
3. Select **Camera:**.
4. Select the feed you want to display.

22.3 Displaying multiple camera feeds using Quad View

When an IP camera is available on the network, the Camera application can be set to Quad View. In Quad View up to 4 camera feeds can be viewed simultaneously.

Quad View can consist of up to 4 x IP feeds or 1 x analog feed and up to 3 x IP feeds.



To enable Quad View, from the Camera application:

1. Select **Menu**.
2. Select **Camera View**.
3. Select **Layout:** so that Quad View is displayed.
4. Arrange the feeds by selecting a feed in each of the **Top-Left**, **Top-Right**, **Bottom-L** and **Bottom-R** menu options as required.

Analog feeds can only be displayed in the top left corner.

5. The top left corner can also be set to cycle through all available analog and IP feeds using the cycling options available in the **Top-Left** menu.

See [22.4 Camera cycling](#) for details of cycling feeds.

Recording, taking photos, naming feeds and adjusting the video image are not supported in Quad View; however it is possible to switch to Quad View whilst recording in Single View.

Note: Except for **gS Series** displays, Quad View is not available on **MFDs** with a 9 inch or below screen size when the Camera application is being viewed as part of a splitscreen page.

Note: Displaying multiple IP feeds on multiple **MFDs** simultaneously may cause some feeds to not be displayed.



Using onscreen controls

On touchscreen displays, onscreen controls are available to quickly switch between Quad View and Single View.

In Quad View:

1. Select the feed.

The Expand icon  is displayed.

2. Select the Expand icon to view the feed in fullscreen.

3. Select the fullscreen feed.



The Quad View icon is displayed.

4. Select the Quad View icon to switch the Camera application back to Quad View.

22.4 Camera cycling

When multiple feeds are available the Camera application can be set up to automatically cycle through the available feeds at a specified time interval.

Note: Camera cycling is not available when the Camera application is viewed as part of a splitscreen page.

With camera cycling turned on the Camera application will cycle through the display's available video input(s) and any available networked IP camera feeds. The feeds will be cycled in the order they appear in the Camera selection menu: **Menu > Camera View > Camera:**. Direct video input feeds will appear first followed by any networked IP camera feeds. When the final feed in the list has been displayed the Camera application will loop back to the first feed in the list.

Camera cycling will cycle through the multifunction display's available video input(s) even if no feed is connected to the input(s). When no feed is present on a video input the 'No video source available' message is displayed. You can choose whether or not the video input(s) appear during camera cycling.

The time interval that each feed is displayed, before switching to the next feed can be adjusted.

Enabling camera cycling

Camera cycling can be enabled independently in both Single View and Quad View.

From the camera application:

1. Select **Menu**.
2. Select **Camera View**.
3. Select **Camera Cycling**.
4. Select **Camera Cycling:** so that On is highlighted.

Selecting Camera Cycling will switch cycling On and Off.

When the menu is closed the camera application will cycle through all available feeds at the defined time interval.

Setting the time interval for camera cycling

The time interval that each video feed is displayed for can be adjusted. The time interval specified will apply to Camera cycling in Single View and Quad View.

From the Camera application, with Camera cycling turned on:

1. Select **Menu**.
2. Select **Camera View**.
3. Select **Camera Cycling**.
4. Select **Cycle Interval:**

The cycle interval adjustment control is displayed.

5. Adjust the setting to the required time interval.

During camera cycling each feed is displayed for the specified time before changing to the next feed.

Showing or hiding video input feeds during camera cycling

By default your multifunction display's video input(s) are shown during cycling, even if no feed is connected. You can choose to Include or Exclude video input(s) from Camera cycling. The Input(s) included or excluded will apply to both Single View and Quad View.

From the Camera application:

1. Select **Menu**.
2. Select **Camera View**.
3. Select **Camera Cycling**.
4. Select the **Include <Camera Name>**: option for the video input you want to Show or Hide.
Selecting **Include <Camera Name>**: option will switch between showing or hiding the video input during camera cycling.

Note: In the steps above **<Camera Name>** represents the default feed name provided by the connected device or the custom name which can be assigned to the feed.

Turning off camera cycling

You can turn off Camera cycling using the methods detailed below.

From the camera application, with camera cycling turned on:

1. Select **Menu > Camera View > Camera Cycling > Camera Cycling**: so that Off is highlighted, or
2. Change the camera / video feed manually.

22.5 Naming camera / video feeds

To help distinguish between camera feeds each feed can be named.

From the Camera application:

1. Select the feed you want to name so that it is displayed on the screen.
2. Select **Menu**.
3. Select **Adjust**.
4. Select **Edit Name**.
The onscreen keyboard is displayed.
5. Enter the name you want the feed to be called.
6. Select **SAVE** to save the new name for the feed.

The name of the feed is displayed in the camera application's status bar.

22.6 Adjusting the video image

If supported by your connected camera / video input device or networked IP camera, you can adjust the image settings.

With a video feed displayed in the Camera application:

1. Select **Menu**.
2. Select **Adjust**.
3. Select **Contrast**, **Brightness**, or **Color**, as appropriate.

The numeric adjust control is displayed.

4. Adjust the level to the required setting.

22.7 Selecting the aspect ratio

If supported by your connected camera / video input device or networked IP camera, you can manually change the aspect ratio between 4:3 and 16:9.

From the camera application with a feed displayed:

1. Select **Menu**.
2. Select **Adjust**.
3. Select **Aspect ratio** so that 4:3 or 16:9 is selected as required.

22.8 Selecting a location to store recordings

In order to record, playback or capture a still image of IP camera feeds you must select the location you want to save to.

If saving to a memory card ensure that a memory card with sufficient space is inserted into the relevant card reader slot.

Note: Do not save files to cartography chart memory cards.

From the Camera application:

1. Select **Menu**.
2. Select **Set-up**.
3. Select **Save Files to:**.
4. Select the location from the list:
 - SD1
 - SD2
 - Internal (default)

SD1 and SD2 will only be selectable if a memory card is inserted into the relevant slot.

Note: If your multifunction display only has 1 card reader slot then only SD1 and Internal is displayed.

22.9 Record and playback

The Camera application can be used to record live IP camera feeds from a connected IP camera. The recording can then be played back at any time.

The camera application records IP camera feeds in .mp4 format which can be saved to a memory card or to the display's internal storage.

The Camera application titlebar displays the name of the feed being recorded and a recording timer is displayed onscreen that shows the elapsed time.

Recording an IP camera feed

To record the feed from an IP camera follow the steps below.

From the Camera application:

1. Select **Menu**.
2. Select **Videos**.
3. Select **Record**.

The recording will start.

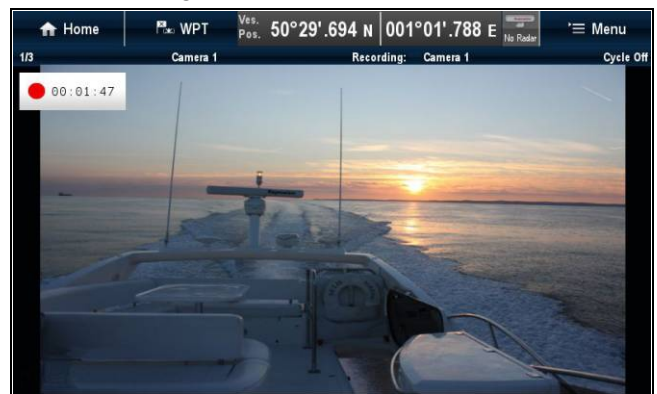

Whilst the camera application is recording you can use your multifunction display as normal e.g. view a different camera feed, go back to the Homescreen, or open a different application. The selected feed will continue to record until stopped or until the memory of the selected location is full.

Note: On a touchscreen display you can also start a recording using the onscreen icons. Refer to [Onscreen icons](#).

Approximate record times

The approximate record times are dependant on IP camera resolution and settings, lighting conditions and available storage space.

A **Raymarine® CAM200IP**, set to factory default settings can record at an approximate rate of 22.5 MB per minute; allowing up to 44 minutes of record time per 1 GB of available storage space.

Note: Recordings and images can be saved to the **MFDs** internal storage, refer to the [Internal storage](#) section for approximate available storage.

Stop recording

Recording can be stopped at any time.

From the Camera application:

1. Select **Menu**.
2. Select **Videos**.

3. Select **Stop**.

The File is saved and the Video Saved confirmation dialog is displayed.

4. Select **OK** to confirm, **Play** to playback the recorded file or **Delete** to delete the file.

The confirmation dialog will automatically close after 5 seconds.

Playing back a video file

You can playback video clips using the Camera application.

From the Camera application:

1. Select **Menu**.
2. Select **Videos**.
3. Select **View**.

The My Files browser is opened.

4. Locate the Video file you want to view.

Video files stored on internal storage are saved in **Internal > User Data > Video files**.

Video files stored on memory card are saved in **SD Card # > Raymarine > Video files**.

5. Select the Video file.

The file options dialog is displayed.

6. Select **Play Video**.

The Video file is played.

You can also playback video clips from the My Data menu from the Homescreen: **Homescreen > My Data > Images and Videos**.

Moving and copying video files

You can copy and move files between your display's internal storage and memory cards using the steps below.

Ensure you have a memory card inserted in the card reader.

From the Camera application:

1. Select **Menu**.
2. Select **Videos**.
3. Select **View**.

The My Files browser is opened.

4. Locate the relevant video file.

Video files stored on internal storage are saved in **Internal > User Data > Video files**.

Video files stored on memory card are saved in **SD Card # > Raymarine > Video files**.

5. Select the video file.

The file options dialog is displayed.

6. Select **Move** or **Copy**.

7. Confirm the location you want to move or copy the file to.

A progress indicator is displayed e.g.:

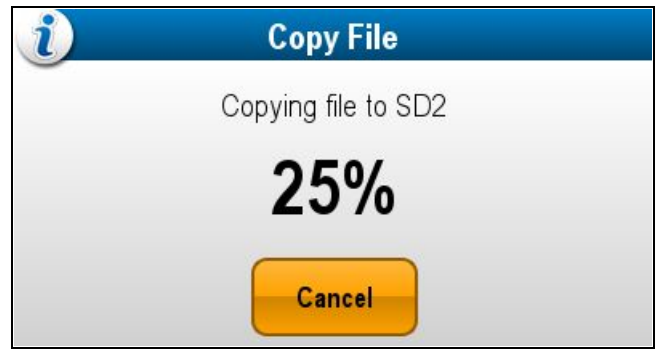



When the operation is complete a confirmation pop-up message is displayed.

8. Select **OK**.

22.10 Taking photos

When a camera feed from an IP camera is displayed you can capture a still image.

Photos can be taken using the following methods:

<p>Capture </p>	<p>Capture — Immediate image capture.</p>
<p>Timer </p>	<p>Timer — You can select the image to be taken in 5, 10 or 30 seconds after selection.</p>
<p>Remote </p>	<p>Remote — You can use a wireless remote control (e.g. the RCU-3) to take the photo.</p>

Taking a photo

To take a photo of what is currently displayed in the Camera application follow the steps below.

If saving to a memory card ensure that a memory card with sufficient space is inserted into the relevant card reader slot.

From the Camera application, with an IP camera feed displayed:

1. Select **Menu**.
2. Select **Photos**.
3. Select **Capture**.

The photo is saved and a confirmation dialog is displayed showing a preview of the picture taken.



4. Select **OK** to confirm.
5. Select **View** to view the picture fullscreen.
6. Select **Delete** to delete the picture.

Note: On a touchscreen display you can also take a photo using the onscreen icons. Refer to [Onscreen icons](#).

Taking a photo using the timer

To take a photo after a defined interval follow the steps below.

If saving to a memory card ensure that a memory card with sufficient space is inserted into the relevant card reader slot.

From the Camera application:

1. Select **Menu**.
2. Select **Photos**.
3. Select **Timer**.
4. Select **Time Delay**.
A list of time intervals is displayed:
 - 5 s
 - 10 s
 - 30 s
5. Select a time interval from the list.
6. Select **Start Timer**.
The photo will be taken after the time delay specified has elapsed. A confirmation dialog is then displayed showing a preview of the photo taken.
7. Select **OK** to confirm.
8. Select **View** to view the photo fullscreen.
9. Select **Delete** to delete the photo.

Taking a photo using a remote control

To take a photo using a Raymarine wireless remote control as the trigger follow the steps below.

If saving to a memory card ensure that a memory card with sufficient space is inserted into the relevant card reader slot.



1. Ensure that your wireless Raymarine remote control is paired to the multifunction display and working.
2. From the Camera application, select **Menu**.
3. Select **Photos**.
4. Select **Remote**.
The Remote dialog is displayed.
5. Press any button on the connected remote control to take a photo.
The photo is saved and a confirmation dialog is displayed showing a preview of the photo.
6. Select **OK** to confirm.
7. Select **View** to view the photo fullscreen.
8. Select **Delete** to delete the photo.



Onscreen icons

On Touchscreen multifunction displays you can touch anywhere on the screen to display the onscreen icons

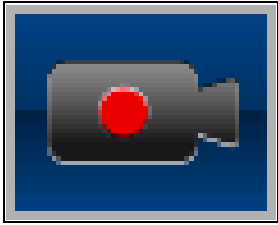
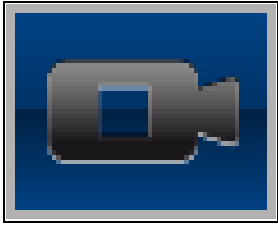
The onscreen icons can be used to start / stop recording or to take a picture.

	Record icon
	Stop Recording icon
	Take Photo icon

The onscreen icons will close after 5 seconds.



Using the onscreen icons

1. Select the **Record icon** to start recording.
2. Select the **Stop recording icon** to stop the recording.
3. Select the **Take Photo icon** to capture a still image.

22.11 Viewing photos

You can view the photos you have taken by following the steps below.

From the Camera application:

1. Select **Menu**.
2. Select **Photos**.
3. Select **View**.
The My Files browser is opened.
4. Locate the photo you want to view.

Photos stored on internal storage are saved in **Internal > User Data > Image files**.

Photos stored on memory card are saved in **SD Card # > Raymarine > Image files**.

5. Select the file.
The file options dialog is displayed.
6. Select **View Image**.
The photo is displayed onscreen.

You can also view images from the My Data menu from the Homescreen: **Homescreen > My Data > Images and Videos**.

Moving and copying Photos

You can copy and move files between your display's internal storage and memory cards using the steps below.

Ensure you have a memory card inserted in the card reader.

From the Camera application:

1. Select **Menu**.
2. Select **Photos**.
3. Select **View**.
The My Files browser is opened.
4. Locate the relevant photo.

Photos stored on internal storage are saved in **Internal > User Data > Image files**.

Photos stored on memory card are saved in **SD Card # > Raymarine > Image files**.

5. Select the file.
The file options dialog is displayed.
6. Select **Move** or **Copy**.
7. Confirm the location you want to move or copy the file to.

A progress indicator is displayed e.g.:

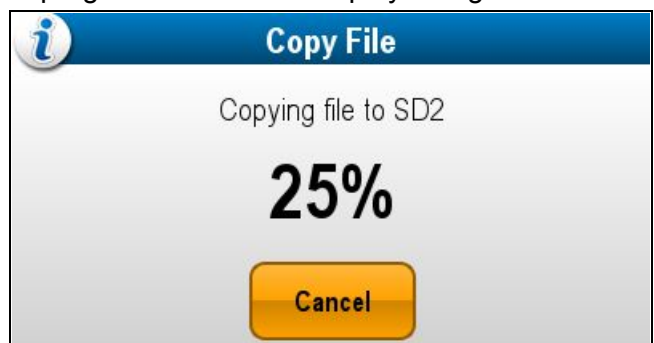

When the operation is complete a confirmation pop-up message is displayed.

8. Select **OK**.

Chapter 23: Thermal camera application — Pan and tilt cameras

Chapter contents

- [23.1 Thermal camera application overview on page 342](#)
- [23.2 Thermal camera image on page 342](#)
- [23.3 Controls overview on page 343](#)
- [23.4 Camera control on page 344](#)
- [23.5 Image adjustments on page 346](#)
- [23.6 Pan and tilt camera — new camera interface on page 349](#)
- [23.7 High power and high torque modes on page 352](#)
- [23.8 Pan and tilt camera — old camera interface on page 353](#)

23.1 Thermal camera application overview

The thermal camera application enables you to control a connected thermal camera and display its image on your multifunction display.

Thermal imaging (also known as infrared) cameras enable you to see clearly in low-light and no-light conditions. For example, a thermal camera can help you navigate at night or identify obstacles in areas of low visibility or even total darkness.

The thermal application enables you to:

- **Control the camera:**
 - Pan.
 - Tilt.
 - Zoom (range).
 - Return camera to “home” (default) position.
 - Set the camera “home” position.
 - Pause the camera image.
 - Toggle between visible light and thermal camera lenses.
 - Toggle surveillance mode.
- **Adjust the camera image:**
 - Color palette.
 - Scene presets.
 - Brightness.
 - Contrast.
 - Color.
 - Video polarity (reverse video color).

Displaying the thermal camera application

With the home screen displayed:

1. Select a page icon that includes the thermal camera application.
The thermal camera application is displayed.

Note: If the home screen does NOT include a page icon that features the thermal camera application you will need to create a new page icon featuring the thermal camera application.

23.2 Thermal camera image

The thermal camera provides a video image which is shown on your display.



The video feed provides:





- Thermal image.
- Status icons / system information.













You should take time to familiarize yourself with the thermal image. This will help you to make the most of your system:

- Consider every object you view in terms of how it will look “thermally” as opposed to how it looks to your eye. For example look for changes caused by the heating effect of the sun. These are particularly evident right after sunset.
- Experiment with white-hot and black-hot (reverse video) modes.
- Experiment by looking for hot objects (such as people) compared to the colder surroundings.
- Experiment with the camera for daytime viewing. The camera can provide improved daytime viewing in environments where traditional video camera performance suffers, such as in shadows or backlit scenes.

Thermal camera status icons

The thermal camera image includes icons to show the current status of the camera.

Icon	Description
	Camera direction indicator.
	Camera home position.
	Camera paused.
	Scene preset mode for night conditions.
	Scene preset mode for daytime conditions.

Icon	Description
	Scene preset mode for night docking.
	Scene preset mode for identifying people or objects in the water.
	Rear-view mode — image is flipped horizontally.
	Zoom setting: 2x zoom.
	Zoom setting: 4x zoom.
	Single active controller on network.
	Multiple active controllers on network.
	PC / laptop detected on network.
	Point mode enabled.
	Point mode disabled.
	Stabilization Off.
	Stabilization On.

FFC (Flat Field Correction)

Periodically the camera will perform a Flat Field Correction (FFC). This will fine tune the thermal image to suit the current ambient temperature.

The FFC operation is indicated by a momentary pause and a green rectangle displayed in the upper left of the thermal video image.

23.3 Controls overview

The thermal camera application is available on compatible Raymarine multifunction displays and systems. It includes controls for the thermal camera.

Rotary control	Zoom image in / out.
Joystick	<ul style="list-style-type: none"> • Pan and tilt camera <div style="border: 1px solid black; padding: 5px; margin: 5px 0;"> <p>Note: On touchscreen displays you can also use the touchscreen to pan and tilt the camera.</p> </div> <ul style="list-style-type: none"> • Navigate menus
OK	Confirm menu selection
CANCEL / Back	Cancel selection
RANGE IN / OUT	Zoom image in / out.

23.4 Camera control

Power up and standby

When the breaker connecting power to the camera is switched on, the camera will run a boot up sequence lasting for about 1 minute, after which the camera will be in **Standby** mode.

In order for the camera to operate, you must bring the camera out of standby mode using the camera controls.

Thermal camera standby

Standby mode can be used to temporarily suspend the thermal camera's functions when the camera is not needed for a prolonged period.

When in standby mode the camera:

- Does NOT provide a live video image.
- Moves the camera into its “stowed” (parked) position (lens facing down into the camera base) to protect the camera optics.
- Engages its pan / tilt motors to hold the camera in place in rough seas.

Note: The “stowed” (parked) position can be configured using the camera's setup menu.

Enabling and disabling thermal camera standby

With the thermal camera application displayed:

1. Select **Menu**.
2. Use the **Standby** menu item to switch the camera in and out of standby mode.

Note: You can also use any of the camera controls in the thermal camera application to “wake” the camera from standby mode.

Pan, tilt and zoom

The camera controls allow for pan and tilt (elevation) of the camera, as well as zoom (magnification) of the thermal image.

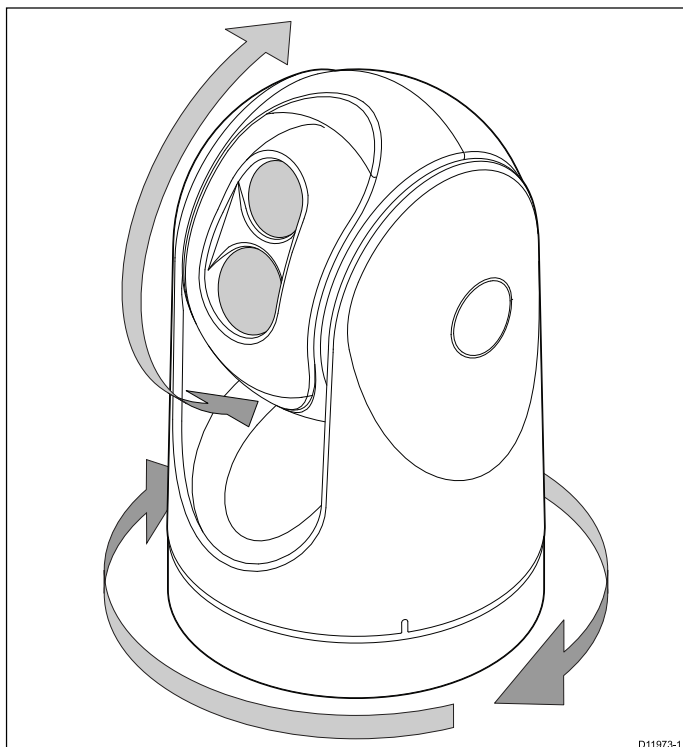

- Pan continuously through 360°.
- Tilt (elevate) to $\pm 90^\circ$ relative to the horizon.
- Zoom (magnify) the thermal camera image.

Note: Stabilized variants of the T-Series thermal cameras include a continuous zoom function, non-stabilized variants can switch between x2 and x4 magnification.



Panning and tilting, and the thermal image

On a touchscreen multifunction display you can pan and tilt the thermal camera image using the touchscreen.

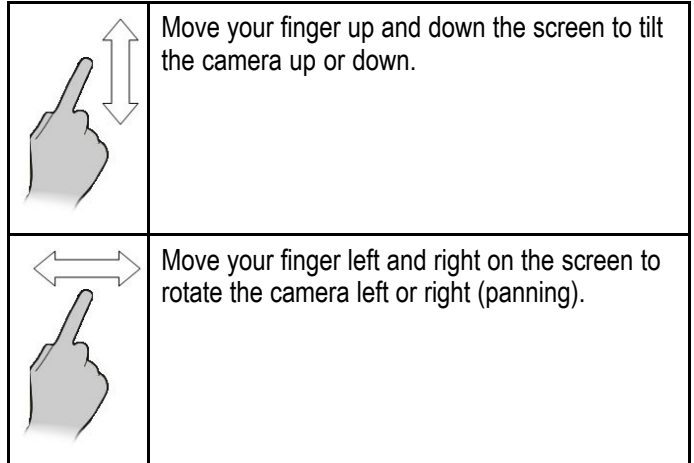

Thermal camera home position

The home position is a preset position for the camera.

The home position usually defines a useful reference point — for example, straight ahead and level with the horizon. You can set the home position as required and to return the camera to the home position at any time.

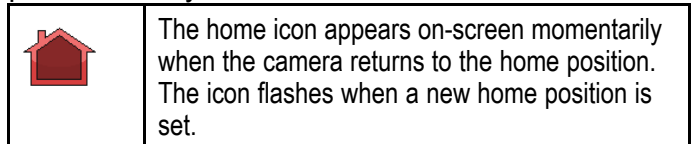

Resetting the thermal camera to the home position

When connected to a pan, tilt thermal camera the home position of the camera can be set.

In the thermal camera application:

1. Select **Menu**.
2. Select **Camera Home**.
The camera returns to its currently defined home position, and the “Home” icon appears on-screen momentarily.

Setting the thermal camera home position

With the thermal camera application displayed:

1. Use the joystick or touchscreen to move the camera to the desired position.
2. Select **Menu**.
3. Select **Camera Set-up**.
4. Select **Set Home Position**.
The “Home” icon flashes on-screen to indicate that a new home position has been set.

Pausing the thermal camera image

With the thermal camera application displayed:

1. Select **Menu**.
2. Select **Pause Image**.

Thermal camera surveillance mode

In surveillance mode the camera pans left and right continuously.

The camera continues to pan until surveillance mode is disabled, or the camera controls are used to move the camera. When this occurs the camera does not automatically resume surveillance mode and the mode must be enabled again if required.

Enabling and disabling thermal camera surveillance mode

With the thermal camera application displayed:

1. Select **Menu**.
2. Select **Image Options**.
3. Use the **Surveillance** menu item to select the On or Off option, as appropriate.

Surveillance mode settings

The scan width and scan speed can be adjusted.

Scan Width

The scan width determines the distance that the camera pans left and right when in surveillance mode.

Scan Speed

The scan speed determines the speed at which the camera pans left and right when in surveillance mode.

Setting scan width

The surveillance mode scan width can be adjusted by following the steps below.

From the thermal camera application:

1. Select **Menu**.
2. Select **Camera Set-up**.
3. Select **Surveillance Settings**.
4. Select **Scan Width**.

The scan width options will be displayed:

- **Narrow** — The camera will scan approximately 20° left and right of the center (40° total).
 - **Medium** — The camera will scan approximately 40° left and right of the center (80° total).
 - **Wide** — The camera will scan approximately 80° left and right of the center (160° total).
5. Select the required option.

Setting scan speed

The surveillance mode scan speed can be adjusted by following the steps below.

From the thermal camera application:

1. Select **Menu**.
2. Select **Camera Set-up**.
3. Select **Surveillance Settings**.
4. Select **Scan Speed**.

The scan speed options will be displayed:

- **Slow**
- **Medium**
- **Fast**

5. Select the required option.

Thermal camera stabilization

The Raymarine T470SC and T473SC thermal cameras includes a mechanical stabilization feature.

The mechanical stabilization feature improves image stability by compensating for vessel motion and keeping the camera aimed at the point of interest. Mechanical stabilization has two aspects: horizontal (azimuth) and vertical (elevation). By default, mechanical stabilization is set to on, which provides the best on-the-water performance particularly when the vessel is underway and traveling on rough water or in swell conditions. You can disable or enable stabilization whenever you want. When you enable full stabilization (horizontal and vertical), the Stabilization On (no wave) icon flashes. It does not display continually, since this is the normal mode of operation. If you disable stabilization, the Stabilization Off (wave) icon remains on the screen to make you aware that the motion of the vessel can affect the camera performance. This is not a normal mode of operation. Stabilization is automatically turned off when the camera is stowed, but the system restores your setting when the camera is powered on. You can turn off the horizontal (pan) stabilization while retaining the tilt stabilization by enabling point mode.

Enabling / Disabling stabilization

Stabilization is enabled by default. You can enable or disable stabilization at any time by following the steps below.

From the thermal camera application

1. Select **Menu**.
2. Select **Camera Set-up**.
3. Select **Stabilization Mode**.
Selecting Stabilization mode switches stabilization On and Off.

Thermal camera point mode

Point mode is only applicable to thermal cameras which have mechanical stabilization.

Enabling point mode only has significance when stabilization is enabled. Enabling point mode turns off the horizontal (pan) stabilization while retaining the vertical (tilt) stabilization. This can be helpful when you want to use the thermal camera as an aide to navigation and keep the camera pointing in the same position relative to the vessel as it turns. For example, you may have stabilization enabled and have set the camera to point straight ahead relative to the front of the vessel. If the vessel is turned at a sharp angle under these conditions, the camera sensor will not follow the direction of the vessel. Enabling point mode keeps the camera in sync with the vessel direction while maintaining a stable elevation position. When point mode is enabled, a lock icon displays. The camera's azimuth position

is now locked to the base. When you disable point mode, the unlock icon displays momentarily. The camera always starts up with point mode disabled.

Enabling / Disabling point mode

Point mode is disabled by default. With Stabilization enabled you can also enable point mode at any time by following the steps below.

From the thermal camera application:

1. Select **Menu**.
2. Select **Camera Set-up**.
3. Select **Point Mode**.

Selecting point mode switches point mode On and Off.

23.5 Image adjustments

Adjusting the thermal camera image





With the thermal camera application displayed:

1. Select **Menu**.
2. Select **Adjust Contrast**.
3. Select the Contrast, Brightness, or Color option as appropriate.
The relevant numeric adjust control is displayed.
4. Adjust the value as required.
5. Select **Back** or **Ok** to confirm the new value.

Thermal camera scene presets

Scene presets enable you to quickly select the best image setting for the current environmental conditions.

During normal operation the thermal camera automatically adjusts itself to provide a high-contrast image optimized for most conditions. The Scene presets provide 4 additional settings that may provide better imagery in certain conditions. The 4 modes are:

	Night Running — scene preset mode for night conditions.
	Day Running — scene preset mode for daytime conditions.
	Night Docking — scene preset mode for night docking.
	Search — scene preset mode for identifying people or objects in the water.

Although the preset names indicate their intended use, varying environmental conditions might make another setting more preferable. For example, the night running scene preset might also be useful while in a harbor. You may find it beneficial to experiment with the different scene presets to discover the best preset to use for different conditions.

Changing the thermal camera scene preset

With the thermal camera application displayed:

1. Select **Menu**.
2. Select **Image Options**.
3. Use the **Scene** menu item to switch between the available scene presets, as appropriate.

Thermal camera color modes

A range of color modes are available to help you distinguish objects on-screen in different conditions.

Changing the color mode switches the thermal camera image between a greyscale mode and 1 or more color modes. There are 5 color modes available.

The factory default color mode is white, which may improve your night vision. This default mode can be changed if required using the camera's on-screen **Video Setup** menu.

Note: If you have the Disable Color Thermal Video option selected in the camera's on-screen **Video Setup** menu, only 2 color modes are available — greyscale and red.

Changing the thermal camera color mode

With the thermal camera application displayed:

1. Select **Menu**.
2. Select **Image Options**.
3. Use the **Colour** menu item to switch between the available color palettes, as appropriate.

Thermal camera reverse video

You can reverse the polarity of the video image to change the appearance of objects on-screen.

The reverse video option (video polarity) switches the thermal image from white-hot (or red-hot if the color mode setting is active) to black-hot. The difference between white-hot and black-hot is shown below:



You may find it useful to experiment with this option to find the best setting to suit your needs.

Enabling thermal camera reverse video

With the thermal camera application displayed:

1. Select **Menu**.
2. Select **Image Options**.
3. Select **Reverse Video**.

Thermal and visible-light operation

“Dual payload” thermal cameras are equipped with 2 cameras — a thermal imaging (infrared) camera and a visible-light camera.



Thermal camera — provides night-time imagery, based on temperature differences between objects. Thermal imaging produces a clear image even in total darkness.



Visible-light camera — provides black and white (or greyscale) imagery during the day and in low-light conditions. Helps to improve navigational abilities in low-light conditions; for example during twilight hours when operating along intercoastal waterways and near harbor entrances.

Note: The T470SC and T473SC have a color camera and continuous zoom lens.

Switching between thermal and visible-light camera lenses

With the thermal camera application displayed:

1. Select **Menu**.
2. Select **Image Options**.
3. Use the **Image Type** menu item to switch between IR and Visible Light views, as appropriate.

Thermal camera rear view mode

The rear view mode flips the video image horizontally, providing a “mirror image”.

This is useful for example in instances where the camera is rear-facing and you are viewing the image on a forward-facing monitor.

Enabling thermal camera rear view mode

With the thermal camera application displayed:

1. Select **Menu**.
2. Select **Image Options**.
3. Select **Rear View**.

Slew to Cue

Slew to cue is a feature which maintains a selected position or object in the thermal cameras field of view. Slew to Cue options are available in the chart and radar applications as target context menu items.

Note: Heading data must be available on the system for Slew to Cue to work correctly.

For details on how to select a target to 'slew to' refer to the radar and chart sections of your manual.

The thermal camera can also automatically slew to:

- MOB target
- Dangerous AIS target
- Dangerous MARPA target

Options to enable or disable the automatic slew options are available in the thermal camera application

Setting the camera's height above sea level

To ensure that the thermal camera's alignment can be set correctly the height of the camera above sea level must be set.

From the thermal camera application:

1. Select **Menu**.
2. Select **Camera Set-up**.
3. Select **Slew Settings**.
The Slew settings page is displayed.
4. Select **Camera height above sea level**.
The Camera height above sea level pop up is displayed.
5. Adjust the value to the required setting.

Aligning the thermal camera horizontally

If you find that slew to cue objects are consistently too far left or right on the screen then you can make fine adjustments to the cameras alignment by following the steps below.

From the thermal camera application:

1. Select **Menu**.
2. Select **Camera Set-up**.
3. Select **Align camera**.
The Align camera to boat pop up is displayed.
4. Adjust the value to the required setting.
This value will adjust the camera's offset position to port or starboard.

Aligning the thermal cameras elevation

If you find that slew to cue objects are consistently too low or high on the screen then you can make fine adjustments to the cameras alignment by following the steps below.

From the thermal camera application:

1. Select **Menu**.
2. Select **Camera Set-up**.
3. Select **Elev Align**.
The Align camera to boat pop up is displayed.
4. Adjust the value to the required setting.
This value will adjust the camera's offset position to port or starboard.

Enabling / disabling automatic slew to cue

From the thermal camera application:

1. Select **Menu**.
2. Select **Camera Set-up**.

3. Select **Slew Settings**.

The Slew settings page is displayed which includes the following auto slew options:

- Auto Slew to MOB
- Auto Slew to Dangerous AIS target
- Auto Slew to Dangerous MARPA target

4. Select the relevant option.

Selecting an option from the list will switch the auto slew option for that item On or Off.

23.6 Pan and tilt camera — new camera interface

The thermal camera application menu options for a pan and tilt thermal camera with the new camera interface are shown below.

Activate Camera	Brings the thermal camera out of standby mode. (only available when camera is in standby.)
Pause Image	<ul style="list-style-type: none"> • On • Off (default)
Camera Home	Select to return the camera to its home position.
Image Options	<p>Select to display the Image Options sub-menu.</p> <ul style="list-style-type: none"> • Color <ul style="list-style-type: none"> – Red – Greyscale – Glowbow – Rainbow – Fusion • Scene <ul style="list-style-type: none"> – Night Running – Night Docking – Day Running – Man Overboard • Thermal / Visible • Reverse video • Rear View • Surveillance
Adjust Contrast	<p>Select to display the Adjust Contrast sub-menu.</p> <ul style="list-style-type: none"> • Contrast • Brightness • Color
Standby	Select to place the camera in to standby mode. (only available when camera is activated.)
Camera Set-up	<p>Select to display the Camera Set-up menu.</p> <ul style="list-style-type: none"> • Set Home Position • Slew Settings • Align Camera • Elev Align: • Surveillance Settings • Default Color • Icon Level • Stabilization Mode • Point Mode • Ball Down Mode • High Power Standby • High Power Torque • JCU Icon • PC Icon

- Restore Factory Defaults
- Calibrate Platform

Camera Set-up menu

Set Home Position	Sets the camera's current position as the Camera Home position.	
Slew Settings	Provides automatic slew options and camera alignment settings.	<ul style="list-style-type: none"> • Auto Slew to MOB • Auto Slew to dangerous AIS target • Auto Slew to dangerous MARPA target • Camera height above sea level
Align Camera	Enables changes to camera's horizontal alignment.	
Elev Align	Enables changes to camera's elevation (vertical) alignment.	
Surveillance Settings	Enables you to set the speed and width the camera will scan when in surveillance mode.	<ul style="list-style-type: none"> • Scan Speed <ul style="list-style-type: none"> – Slow – Medium – Fast • Scan Width <ul style="list-style-type: none"> – Narrow – Medium – Wide
Default Color	Enables selection of default color palette.	<ul style="list-style-type: none"> • Red • Greyscale • Glowbow • Rainbow • Fusion
Icon Level	Enables selection of level of icons displayed on-screen.	<ul style="list-style-type: none"> • None • Minimal • All
Stabilization Mode	Enables and disables stabilization mode. Note: Only available on stabilized variants of the T-Series cameras.	<ul style="list-style-type: none"> • On (default) • Off
Point Mode	Enables and disables point mode.	<ul style="list-style-type: none"> • On • Off (default)
Ball Down Mode	This options should be enables when the camera is mounted upside down in the 'ball down' configuration.	<ul style="list-style-type: none"> • On • Off (default)
High Power Standby	This option controls the amount of power used to hold the camera in position while it is in standby mode. With the setting enabled the camera will consume more power, but will help ensure that the camera is held in place in rough seas.	<ul style="list-style-type: none"> • On (default) • Off

High Power Torque	This option controls the amount of power used to hold the camera steady when in use. With the setting enabled the camera will consume more power, but will help ensure that the camera is held in place in rough seas. The High Power Torque mode may be useful for power boats that operate at higher speeds and experience high impact environments, and can accept higher power consumption.	<ul style="list-style-type: none"> • On (default) • Off
JCU Icon	Shows or hides the on-screen JCU connected icon.	<ul style="list-style-type: none"> • On (default) • Off
PC Icon	Shows or hides the on-screen PC connected icon.	<ul style="list-style-type: none"> • On (default) • Off
Restore Factory Defaults	Enables you to restore the camera's settings to factory default values.	
Calibrate platform	The calibrate platform option re-initializes the pan and tilt mechanism in the thermal camera.	

Note: The thermal camera menu options available are dependant on the software version of your multifunction display and thermal camera. If options are different than listed above please refer to the manual that accompanied your thermal camera and / or the installation and operations handbook which accompanied your multifunction display.

23.7 High power and high torque modes

Camera State	Camera setting	Dual payload	Single payload
Standby	<ul style="list-style-type: none"> • High Power Mode ON • High Torque Mode ON 	22 W	17.4 W
Standby	<ul style="list-style-type: none"> • High Power Mode OFF • High Torque Mode ON 	8 W	7.4 W
Standby	<ul style="list-style-type: none"> • High Power Mode ON • High Torque Mode OFF 	13 W	13 W
Awake	<ul style="list-style-type: none"> • High Power Mode OFF • High Torque Mode OFF 	8 W	7.4 W
Awake	<ul style="list-style-type: none"> • High Power Mode ON or OFF • High Torque Mode ON 	30 W	19.4 W
Awake	<ul style="list-style-type: none"> • High Power Mode ON or OFF • High Torque Mode OFF 	20 W	16.5 W

23.8 Pan and tilt camera — old camera interface

The thermal camera application menu options for a pan and tilt thermal camera with the old camera interface are shown below.

Activate Camera	Brings the thermal camera out of standby mode. (only available when camera is in standby.)
Pause Image	<ul style="list-style-type: none"> • On • Off (default)
Camera Home	Select to return the camera to its home position.
Image Options	<p>Select to display the Image Options sub-menu.</p> <ul style="list-style-type: none"> • Color <ul style="list-style-type: none"> – Red – Greyscale – Glowbow – Rainbow – Fusion • Scene <ul style="list-style-type: none"> – Night Running – Night Docking – Day Running – Man Overboard • Thermal / Visible • Reverse video • Rear View • Surveillance
Adjust Contrast	<p>Select to display the Adjust Contrast sub-menu.</p> <ul style="list-style-type: none"> • Contrast • Brightness • Color
Standby	Select to place the camera in to standby mode. (only available when camera is activated.)
Camera Set-up	<p>Select to display the Camera Set-up menu.</p> <ul style="list-style-type: none"> • Set Home Position • Camera menu — (Onscreen display (OSD) menu) • Align Camera

Camera Set-up menu

Set Home Position	Sets the camera's current position as the Camera Home position.
Camera menu	Provides access to the camera's onscreen display (OSD) menu options.
Align Camera	Enables changes to camera's horizontal alignment.

Note: The thermal camera menu options available are dependant on the software version of your multifunction display and thermal camera. If options are different than listed above please refer to the manual that accompanied your thermal camera and / or the installation and operations handbook which accompanied your multifunction display.

Note: It may be possible to update your camera to the new camera interface. Please contact your Raymarine dealer for details.

OSD menu options

Setup menus

The setup menus provide a range of tools and settings to configure the thermal camera.

The menus can be accessed from any controller on the system. The menus are overlaid onto the video image.

Note: The on-screen menus only appear on the thermal camera image. They are not available when viewing the visible light image (on dual payload models).

Menus available

Enable Point Mode / Disable Point Mode	Selecting Enable Point mode will turn point mode on, selecting disable point mode will turn point mode off. Only applies to models with mechanical stabilization.
Video Setup	This menu is used to set the video configuration options.
Set Symbology	Settings associated with the status icons.
User Programmable Button	Configure the USER button on the JCU.
System Setup	Settings to optimize operation for this particular system / installation.
About / Help	Helpful information and restore to factory defaults setting.
Exit	Cancels on-screen menu.

Video setup menu

Menu item / Description	Settings / Operation
Set Thermal Color Default	This saves the current color setting as the default value.
Set Reverse Video or Set Video Polarity	This toggles the infrared image between white-hot (or red-hot if viewing a color image) and black-hot.
Enable / Disable Color Thermal Video	Enable or disable the thermal color palettes: <ul style="list-style-type: none"> • Enabled – Greyscale, Red, Sepia, Rainbow and Fusion palettes are available. • Disabled – Only Greyscale and Red palettes are available.
Display Test Pattern	Use the display test pattern when setting up the color / contrast settings for your particular display or monitor. You can switch through the 4 test patterns available.
Exit	

Set symbology menu

Menu item / Description	Settings / Operation
Enable / Disable PC Icon	<ul style="list-style-type: none"> • Enabled – The PC icon is displayed whenever a PC is detected on the network. • Disabled – The PC icon is not displayed.
Enable / Disable JCU Icon	<ul style="list-style-type: none"> • Enabled – The JCU icon is displayed whenever a JCU is detected on the network. • Disabled – The JCU icon is not displayed.
Display All Icons	Selecting this menu item enables all available icons.
Display Minimal Icons	Selecting this menu item reduces the icon activity: <ul style="list-style-type: none"> • Position, Zoom, Rearview, Pause, Stabilization disabled and Point Mode enabled icons are unaffected. • Home and Scene icons are displayed only momentarily. • Other icons are not shown.
Hide All Icons	Selecting this option hides all icons except for: <ul style="list-style-type: none"> • Position indicator • Rearview mode enabled • Stabilization disabled • Point mode enabled
Exit	Returns to the main menu.

Surveillance mode menu

Menu item / Description	Settings / Operation
Scan Width	<p>This setting determines the distance that the camera pans left and right when in surveillance mode. Select from:</p> <ul style="list-style-type: none"> Narrow — The camera will scan approximately 20° left and right of the center (40° total). Medium — The camera will scan approximately 40° left and right of the center (80° total). Or, Wide The camera will scan approximately 80° left and right of the center (160° total).
Scan Speed	<p>This option determines the speed at which the camera pans left and right when in surveillance mode. Select between:</p> <ul style="list-style-type: none"> Slow Medium Fast
Exit	

System Setup menu

Menu item / Description	Settings / Operation
Enable / Disable Ball-Down Installation	This menu option should be enabled when the camera is mounted upside down in the “ball-down” configuration.
Enable / Disable Twist-to-Pan mode	<p>This menu option changes the JCU controls pan and zoom functions as follows:</p> <p>Enabled — Pan the camera by rotating the Puck clockwise or counterclockwise, zoom in and out by pushing the puck in and pulling it out. (This is default operation of the JCU).</p> <p>Disabled — Pan the camera by moving the Puck left or right, zoom in and out by rotating the Puck clockwise and counterclockwise.</p>
Enable / Disable High Power Standby	<p>This option controls the amount of power used to hold the camera in position while it is in Standby mode. The enabled setting will consume more power, but will help ensure that the camera is held in place in rough seas.</p> <div style="border: 1px solid black; padding: 5px; margin-top: 10px;"> <p>Note: If the camera moves when in standby (due to shock or vibration), then the Position indicator or Home setting may need realigning (reset the camera to realign).</p> </div>

Menu item / Description	Settings / Operation
Enable / Disable High Motor Torque	<p>This option controls the amount of power used to hold the camera steady when in use. The enabled setting will consume more power, but help ensure that the camera is held in place in rough seas.</p> <p>The High Motor Torque mode may be useful for power boats that operate at higher speeds and experience high impact environments, and can accept higher power consumption.</p> <div style="border: 1px solid black; padding: 5px; margin-top: 10px;"> <p>Note: If the camera moves due to shock or vibration, then the Position indicator or Home setting may need realigning (reset the camera to realign).</p> </div>
Enable / Disable Rearview Mode	When this option is enabled the camera image is reversed and you will see a mirror image on the display.
Enable / Disable Stabilization	When this option is enabled horizontal and vertical stabilization is turned on. Only applies to T470SC and T473SC.
Set Stow Position	This option sets the current position as the Stow position. The camera moves to the stow position whenever it is turned off or put into Standby mode.
Name Camera	Use this option to name the camera.
Surveillance mode	This options enables you to set the scan width and speed when in surveillance mode.
Exit	Exit to main menu.

High power / High torque power use

Camera State	Camera setting	Dual payload	Single payload
Standby	<ul style="list-style-type: none"> High Power Mode ON High Torque Mode ON 	22 W	17.4 W
Standby	<ul style="list-style-type: none"> High Power Mode OFF High Torque Mode ON 	8 W	7.4 W
Standby	<ul style="list-style-type: none"> High Power Mode ON High Torque Mode OFF 	13 W	13 W
Awake	<ul style="list-style-type: none"> High Power Mode OFF High Torque Mode OFF 	8 W	7.4 W

Camera State	Camera setting	Dual payload	Single payload
Awake	<ul style="list-style-type: none"> High Power Mode ON or OFF High Torque Mode ON 	30 W	19.4 W
Awake	<ul style="list-style-type: none"> High Power Mode ON or OFF High Torque Mode OFF 	20 W	16.5 W

User Programmable Button menu

Use this menu to set up the **USER** button on the JCU.

Menu item / Description	USER button operation
Search settings	The USER button will set the camera scene to Search mode.
Switch Thermal / VIS Video (Dual payload models only)	The USER button will switch between Thermal and Low Light camera images.
Hide / Show All Icons	The USER button will toggle between Show and Hide icon settings.
Reverse Video	The USER button will toggle between the White-hot and Black-hot (reverse) thermal image.
Rearview Mode	The USER button will toggle Rearview mode on and off.
Surveillance Mode	The USER button will toggle Surveillance mode on and off.
Point Mode	The USER button will toggle Point Mode on and off.
Exit	Returns to the main menu.

Chapter 24: Thermal camera application — fixed mount cameras

Chapter contents

- [24.1 Thermal camera application overview on page 358](#)
- [24.2 Thermal camera image on page 358](#)
- [24.3 Controls overview on page 359](#)
- [24.4 Camera control on page 360](#)
- [24.5 Image adjustments on page 360](#)
- [24.6 Fixed mount camera menu on page 362](#)

24.1 Thermal camera application overview

The thermal camera application enables you to control a connected thermal camera and display its image on your multifunction display.

Thermal imaging (also known as infrared) cameras enable you to see clearly in low-light and no-light conditions. For example, a thermal camera can help you navigate at night or identify obstacles in areas of low visibility or even total darkness.

The thermal application enables you to:

- **Control the camera:**
 - Zoom (range).
 - Pause the camera image.
- **Adjust the camera image:**
 - Color palette.
 - Scene presets.
 - Brightness.
 - Contrast.
 - Color.
 - Video polarity (reverse video color).

Displaying the thermal camera application

With the home screen displayed:

1. Select a page icon that includes the thermal camera application.

The thermal camera application is displayed.

Note: If the home screen does NOT include a page icon that features the thermal camera application you will need to create a new page icon featuring the thermal camera application.

24.2 Thermal camera image

The thermal camera provides a video image which is shown on your display.



The video feed provides:

- Thermal image.
- Status icons / system information.







You should take time to familiarize yourself with the thermal image. This will help you to make the most of your system:

- Consider every object you view in terms of how it will look “thermally” as opposed to how it looks to your eye. For example look for changes caused by the heating effect of the sun. These are particularly evident right after sunset.
- Experiment with white-hot and black-hot (reverse video) modes.
- Experiment by looking for hot objects (such as people) compared to the colder surroundings.
- Experiment with the camera for daytime viewing. The camera can provide improved daytime viewing in environments where traditional video camera performance suffers, such as in shadows or backlit scenes.

Thermal camera status icons

The thermal camera image includes icons to show the current status of the camera.

Icon	Description
	Camera paused.
	Scene preset mode for night conditions.
	Scene preset mode for daytime conditions.
	Scene preset mode for night docking.
	Scene preset mode for identifying people or objects in the water.

Icon	Description
	Rear-view mode — image is flipped horizontally.
	Zoom setting: 2x zoom.
	Zoom setting: 4x zoom.
	Single active controller on network.
	Multiple active controllers on network.
	PC / laptop detected on network.

FFC (Flat Field Correction)

Periodically the camera will perform a Flat Field Correction (FFC). This will fine tune the thermal image to suit the current ambient temperature.

The FFC operation is indicated by a momentary pause and a green rectangle displayed in the upper left of the thermal video image.

24.3 Controls overview

The thermal camera application is available on compatible Raymarine multifunction displays and systems. It includes controls for the thermal camera.

Rotary control	Zoom image in / out.
OK	Confirm menu selection.
Joystick	Navigate menus.
CANCEL / Back	Cancel selection.
RANGE IN / OUT	Zoom image in / out.

24.4 Camera control

Power up and standby

When the breaker connecting power to the camera is switched on, the camera will run a boot up sequence lasting for about 1 minute, after which the camera will be in **Standby** mode.

In order for the camera to operate, you must bring the camera out of standby mode using the camera controls.

Thermal camera standby

Standby mode can be used to temporarily suspend the thermal camera's functions when the camera is not needed for a prolonged period.

When in standby mode the camera does not provide a live video image.

Enabling and disabling thermal camera standby

With the thermal camera application displayed:

1. Select **Menu**.
2. Use the **Standby** menu item to switch the camera in and out of standby mode.

Note: You can also use any of the camera controls in the thermal camera application to “wake” the camera from standby mode.

Pausing the thermal camera image

With the thermal camera application displayed:

1. Select **Menu**.
2. Select **Pause Image**.

24.5 Image adjustments

Adjusting the thermal camera image





With the thermal camera application displayed:

1. Select **Menu**.
2. Select **Adjust Contrast**.
3. Select the Contrast, Brightness, or Color option as appropriate.
The relevant numeric adjust control is displayed.
4. Adjust the value as required.
5. Select **Back** or **Ok** to confirm the new value.

Thermal camera scene presets

Scene presets enable you to quickly select the best image setting for the current environmental conditions.

During normal operation the thermal camera automatically adjusts itself to provide a high-contrast image optimized for most conditions. The Scene presets provide 4 additional settings that may provide better imagery in certain conditions. The 4 modes are:

	Night Running — scene preset mode for night conditions.
	Day Running — scene preset mode for daytime conditions.
	Night Docking — scene preset mode for night docking.
	Search — scene preset mode for identifying people or objects in the water.

Although the preset names indicate their intended use, varying environmental conditions might make another setting more preferable. For example, the night running scene preset might also be useful while in a harbor. You may find it beneficial to experiment with the different scene presets to discover the best preset to use for different conditions.

Changing the thermal camera scene preset

With the thermal camera application displayed:

1. Select **Menu**.
2. Select **Image Options**.
3. Use the **Scene** menu item to switch between the available scene presets, as appropriate.

Thermal camera color modes

A range of color modes are available to help you distinguish objects on-screen in different conditions.

Changing the color mode switches the thermal camera image between a greyscale mode and 1 or more color modes. There are 5 color modes available.

The factory default color mode is white, which may improve your night vision. This default mode can be changed if required using the camera's on-screen **Video Setup** menu.

Note: If you have the Disable Color Thermal Video option selected in the camera's on-screen **Video Setup** menu, only 2 color modes are available — greyscale and red.

Changing the thermal camera color mode

With the thermal camera application displayed:

1. Select **Menu**.
2. Select **Image Options**.
3. Use the **Colour** menu item to switch between the available color palettes, as appropriate.

Thermal camera reverse video

You can reverse the polarity of the video image to change the appearance of objects on-screen.

The reverse video option (video polarity) switches the thermal image from white-hot (or red-hot if the color mode setting is active) to black-hot. The difference between white-hot and black-hot is shown below:



You may find it useful to experiment with this option to find the best setting to suit your needs.

Enabling thermal camera reverse video

With the thermal camera application displayed:

1. Select **Menu**.
2. Select **Image Options**.
3. Select **Reverse Video**.

Thermal camera rear view mode

The rear view mode flips the video image horizontally, providing a “mirror image”.

This is useful for example in instances where the camera is rear-facing and you are viewing the image on a forward-facing monitor.

Enabling thermal camera rear view mode

With the thermal camera application displayed:

1. Select **Menu**.
2. Select **Image Options**.
3. Select **Rear View**.

24.6 Fixed mount camera menu

The thermal camera application menu options for a fixed mount thermal camera are shown below.

Activate Camera	Brings the thermal camera out of standby mode. (only available when camera is in standby.)	
Pause Image	<ul style="list-style-type: none"> • On • Off (default) 	
Image Options	Select to display the Image Options sub-menu. <ul style="list-style-type: none"> • Color <ul style="list-style-type: none"> – Red – Greyscale – Glowbow – Rainbow – Fusion • Scene <ul style="list-style-type: none"> – Night Running – Night Docking – Day Running – Man Overboard • Reverse video • Rear View 	
Adjust Contrast	Select to display the Adjust Contrast sub-menu. <ul style="list-style-type: none"> • Contrast • Brightness • Color 	
Standby	Select to place the camera in to standby mode. (only available when camera is activated.)	
Camera Set-up	Select to display the Camera Set-up menu. <ul style="list-style-type: none"> • Default Color • Icon Level • Ball Down Mode • High Power Standby • JCU Icon • PC Icon • Restore Factory Defaults 	

Camera Set-up menu

Default Color	Enables selection of default color palette.	<ul style="list-style-type: none"> • Red • Greyscale • Glowbow • Rainbow • Fusion
Icon Level	Enables selection of level of icons displayed on-screen.	<ul style="list-style-type: none"> • None • Minimal • All

Ball Down Mode	This options should be enables when the camera is mounted upside down in the 'ball down' configuration.	<ul style="list-style-type: none"> • On • Off (default)
High Power Standby	This option controls the amount of power used to hold the camera in position while it is in standby mode. With the setting enabled the camera will consume more power, but will help ensure that the camera is held in place in rough seas.	<ul style="list-style-type: none"> • On (default) • Off
JCU Icon	Shows or hides the on-screen JCU connected icon.	<ul style="list-style-type: none"> • On (default) • Off
PC Icon	Shows or hides the on-screen PC connected icon.	<ul style="list-style-type: none"> • On (default) • Off
Restore Factory Defaults	Enables you to restore the camera's settings to factory default values.	

Note: The thermal camera menu options available are dependant on the software version of your multifunction display and thermal camera. If options are different than listed above please refer to the manual that accompanied your thermal camera and / or the installation and operations handbook which accompanied your multifunction display.

Chapter 25: Fusion link application

Chapter contents

- [25.1 Fusion link overview on page 366](#)
- [25.2 Media sources on page 367](#)
- [25.3 Browsing music on page 369](#)
- [25.4 Selecting shuffle and repeat functions on page 369](#)
- [25.5 Adjusting volume levels for each zone on page 370](#)
- [25.6 Selecting the zone to control on page 370](#)
- [25.7 Adjusting the tone controls on page 371](#)
- [25.8 Selecting the system to control on page 371](#)
- [25.9 Menu options on page 372](#)

25.1 Fusion link overview

The multifunction display can control a connected 700 series Fusion entertainment system.

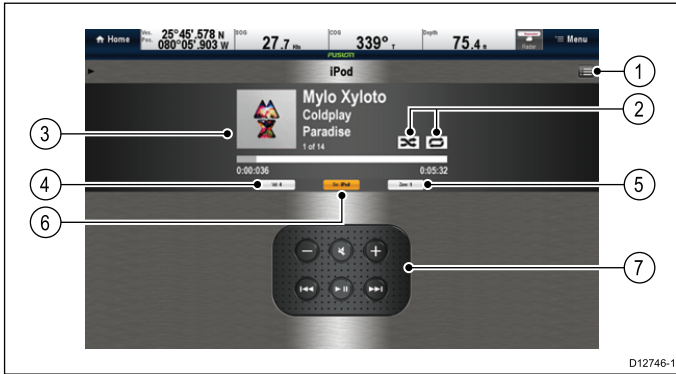

1	Fusion menu options and track lists.
2	Shuffle and Repeat icons.
3	Track / media specific details and controls.
4	Zone volume control.
5	Zone selector.
6	Media source.
7	Media controls (See below).

Note: Album artwork is only available when using an iPod.

Media controls

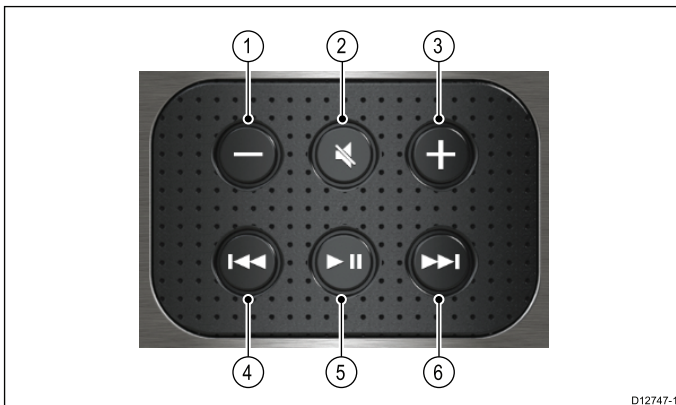

1	Volume Down.
2	Mute / Unmute.
3	Volume Up.
4	<ul style="list-style-type: none"> • Single press — Skips back to the beginning of the current track, subsequent presses will skip backwards through the available tracks. • Press and hold — Scans the current track backwards in 10 seconds intervals.
5	Play / Pause current track.
6	<ul style="list-style-type: none"> • Single press — Skips forward to the next track, subsequent presses will skip forwards through the available tracks. • Press and hold — Scans the current track forwards in 10 seconds intervals.

The Fusion link application can be used to:

- Browse available media sources.

- Adjust the volume level.
- Mute and Unmute the volume.
- Adjust the tone controls (Bass, Middle, and Treble).
- Skip backwards and forwards through tracks.
- Scan backwards and forwards through the current track.
- Play / Pause the current track.
- Select the zone to be controlled. (For information on setting up zones refer to the manual that accompanied your Fusion entertainment system.
- Set Shuffle and Repeat functions.

Accessing the Fusion link application

If more than one Fusion entertainment system is connected to your system then you can choose which system the Fusion link application will control.

1. Select the **FUSION link** page icon from the homescreen.
A list of connected Fusion entertainment systems is displayed.
2. Select the system you want to control.

25.2 Media sources

The layout and controls available are determined by the selected media source.

iPod

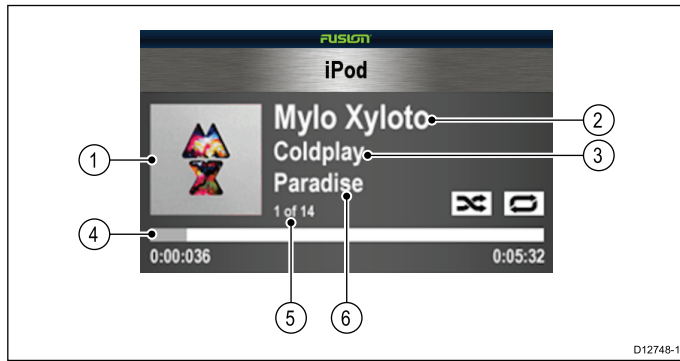

1	Album artwork.
2	Track title.
3	Artist.
4	Track progress.
5	Track number.
6	Album title.

Menu options available for iPods are as follows:

- Browse music.
- Repeat.
- Shuffle.
- Tone Controls.
- Select Fusion System.

USB



1	Track title.
2	Artist.
3	Album title.
4	Track number.
5	Track progress.

Menu options available for USB devices are as follows:

- Browse music.
- Repeat.
- Shuffle.
- Tone Controls.
- Select Fusion System.

DVD

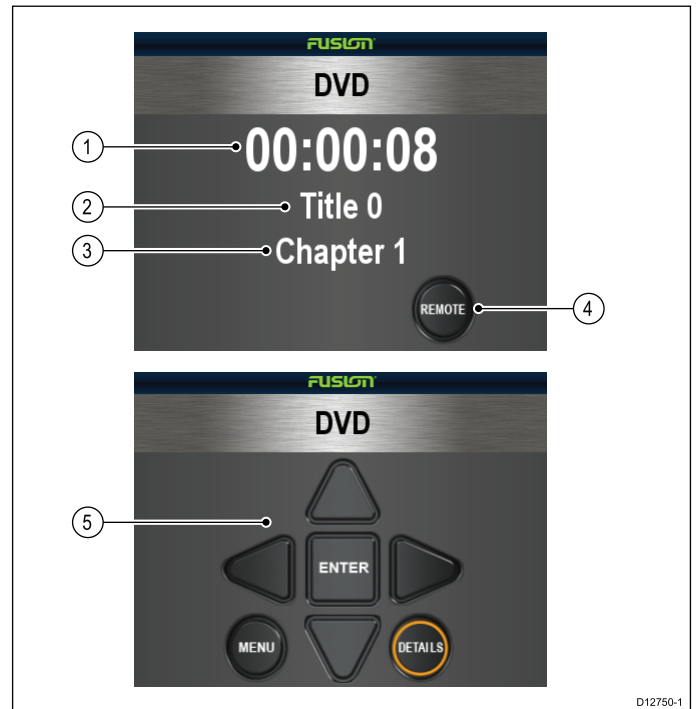

1	Time elapsed.
2	Title.
3	Chapter.
4	Remote button.
5	DVD remote controls including: <ul style="list-style-type: none"> • Directional keypad. • Enter. • Menu. • Details.

Menu options available for DVD devices are as follows:

- Tone Controls.
- Select Fusion System.

AM / FM radio

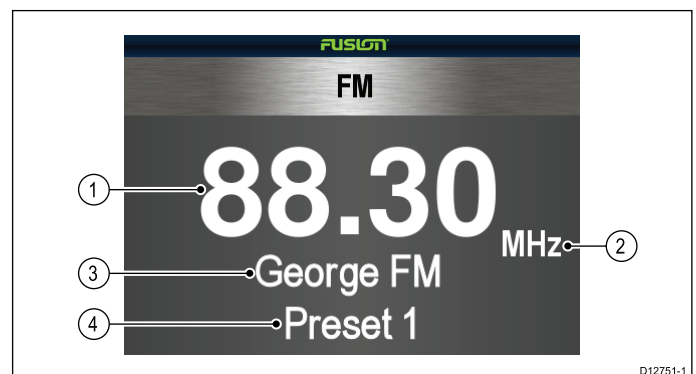

1	Frequency.
2	Frequency type.
3	Channel name.
4	Preset name.

Menu options available for the Radio are as follows:

- Preset.

- Tone Controls.
- Select Fusion System.

VHF

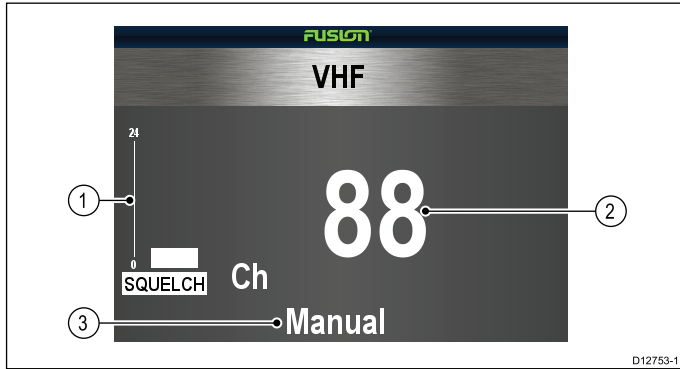

1	Squelch control.
2	Channel.
3	Manual / Auto status.

Menu options available for VHF radios are as follows:

- Preset.
- Scan.
- Tone Controls.
- Select Fusion System.

AUX

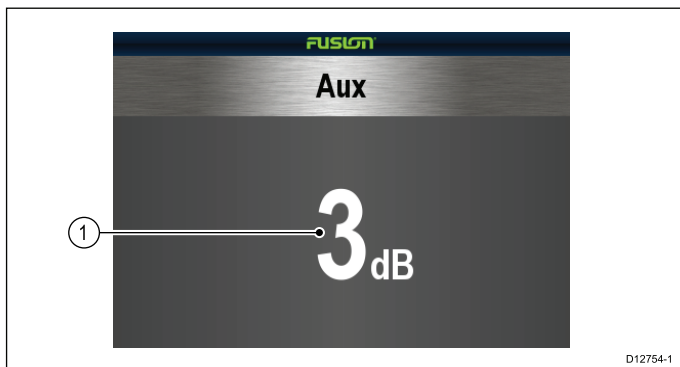

1	Input gain.
---	-------------

Menu options available for AUX devices are as follows:

- Tone Controls.
- Select Fusion System.

Satellite radio

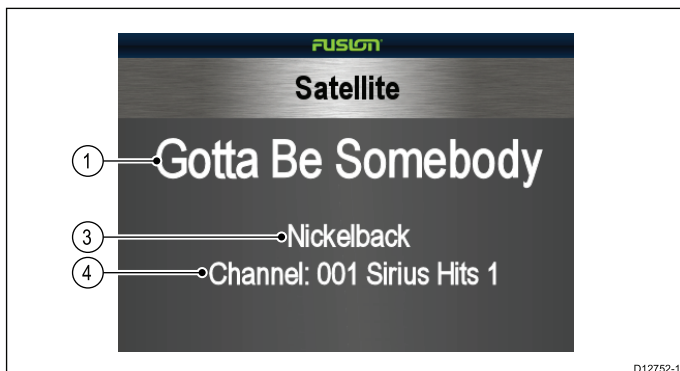

1	Track name.
2	Artist.
3	Channel details.

Note: The Fusion head unit must be used to control a satellite receiver connected to a fusion media system. Current track information and channel details are displayed on the Fusion application.

Selecting a media source

You can select which media source you want to control.



From the Fusion link application:

1. Select **Src:**.
A list of media sources is displayed.
2. Select the relevant media source.

25.3 Browsing music

You can browse the music available on your connected iPod or USB device.

From the Fusion link application:

1. Select the **Menu** icon.
2. Select **Browse Music**.
The media device name is displayed.
3. Select the media device.
The contents of the device are displayed.
4. Browse the available folders by selecting on them.
5. Select the **Back** icon to move back up the folder structure.
6. Select the track that you want to listen to.
The main screen is displayed and the track will begin to play.

25.4 Selecting shuffle and repeat functions

You can set the Fusion link application to repeat the selected folder or to shuffle the play order.

From the Fusion link application:

1. Select the **Menu** icon.
2. Select **Repeat** to switch the repeat folder function on or off.
3. Select **Shuffle** to switch the shuffle function on or off.

25.5 Adjusting volume levels for each zone

The volume level for each zone can be adjusted individually or you can adjust all zones at the same time.

From the Fusion link application:

1. Select **Vol:**.

The zone volume control is displayed.

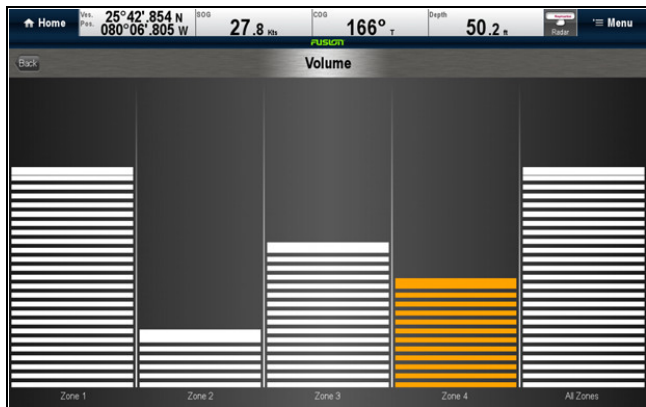

2. Select the relevant zone.
3. Adjust the volume level to the required setting.
4. Select the **Back** icon to go back to the main screen.

Note: Adjusting the All Zones level will adjust all of the zones at the same time.

25.6 Selecting the zone to control

You can select which zone the main screen will control.

From the Fusion link application:

1. Select **Zone:**.

The zone selection bar is displayed.



2. Select the zone you want to control.
3. The volume controls on the main screen will now control the volume level of the selected zone.

25.7 Adjusting the tone controls

The Bass, Middle, and Treble tone controls can be adjusted.

From the Fusion link application:

1. Select the **Menu** icon.
2. Select **Tone Controls**.
3. Select either Bass, Middle, or Treble.
4. Adjust the level to the required setting.
5. Select **Back** to go back to the menu options.
6. Select **Back** from the menu options to go back to the main screen.

25.8 Selecting the system to control

Where more than one Fusion entertainment system is connected you can select which system the Fusion link application will control.

From the Fusion link application:

1. Select the **Menu** icon.
2. Select **Select Fusion system**.
A list of available systems is displayed.
3. Select the system you want to control.

The Fusion link application will now control the selected system.

25.9 Menu options

Menu option	Media sources	Description
Browse Music	<ul style="list-style-type: none">• iPod.• USB.	Enables browsing of music stored on the device.
Repeat	<ul style="list-style-type: none">• iPod.• USB.	<ul style="list-style-type: none">• Off• Folder — Repeats all songs in the current folder.
Shuffle	<ul style="list-style-type: none">• iPod.• USB.	Switches track shuffle on and off.
Tone Controls	<ul style="list-style-type: none">• All devices.	Enables adjustment of the following tone controls: <ul style="list-style-type: none">• Bass.• Middle.• Treble.
Select Fusion system	<ul style="list-style-type: none">• All devices.	Enables you to select the Fusion entertainment system you want to control.
Preset	<ul style="list-style-type: none">• AM / FM Radio.• VHF Radio.	Enables selection and saving of channels as presets.
Scan	<ul style="list-style-type: none">• VHF Radio.	Enables scanning of saved channels.

Chapter 26: Weather application (North America only)

Chapter contents

- [26.1 Weather application overview on page 374](#)
- [26.2 Weather application set up on page 374](#)
- [26.3 Weather application display overview on page 375](#)
- [26.4 Weather map navigation on page 378](#)
- [26.5 Weather context menu on page 378](#)
- [26.6 Weather information on page 379](#)
- [26.7 Weather reports on page 380](#)
- [26.8 Animated weather graphics on page 381](#)
- [26.9 Weather application menu options on page 381](#)
- [26.10 Glossary of weather terms on page 383](#)

26.1 Weather application overview

The weather application overlays historical, live, and forecasted weather graphics on a world map.

The weather application can only be used in North America and its coastal waters.

The weather application graphics and their associated weather data enable you to determine the actual conditions in the vicinity of your vessel, or at a particular location.

Weather forecasts and warnings, detailing both current and predicted conditions, are regularly updated in the weather application.

Note: For types of warnings, watches, and advisories, refer to the NOAA website at www.nws.noaa.gov

Disclaimer — advisory only

The weather information is subject to service interruptions and may contain errors or inaccuracies and consequently should not be relied upon exclusively. You are urged to check alternate weather information sources prior to making safety related decisions. You acknowledge and agree that you shall be solely responsible for use of the information and all decisions taken with respect thereto. By using this service, you release and waive any claims against Sirius Satellite Radio Inc., WSI, Navcast Incorporated, and Raymarine with regard to this service.

If you do not have the subscription agreement, you may view a copy on the internet at www.sirius.com/marineweather

26.2 Weather application set up

A number of steps must be completed before you can use the weather application for the first time.

- Your multifunction display must be connected to a Raymarine Sirius weather receiver.
- Identify your Raymarine Sirius weather receiver's electronic serial number (ESN). This information can be obtained from the homescreen **Set-up** menu by selecting the device from the select devices page: **Set-up > Maintenance > Diagnostics > Select Device >**
- Using your ESN contact SiriusXM (www.siriusxm.com) to subscribe for Sirius Marine Weather (www.siriusxm.com/marineweather). When viewing the multifunction display's weather application, the ESN may be accessed from the following menu: **Menu > Sirius ESN.**
- You must be navigating within US coastal waters.
- Your multifunction display must obtain a GPS fix on your vessels location.
- You must specify the weather graphics that you want to display in the weather application.

Accessing the weather application

To access the weather application on your multifunction display follow the step below:

From the homescreen:

1. Select the **Weather** icon:



26.3 Weather application display overview

The weather application displays a range of graphics to indicate weather conditions and forecast information.

The following diagram illustrates the main features of the weather application display:

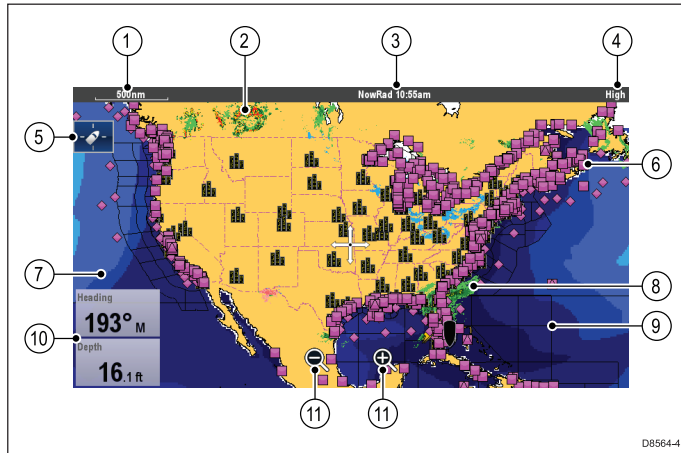

Item	Description
1	Range
2	Canadian radar
3	Animation and time / date
4	Signal strength
5	Find ship icon
6	Surface observation stations
7	Wave heights
8	NOWRad
9	Marine zones
10	Data overlay cells
11	On-screen Range in and out icons (Touchscreen displays only)

Weather symbols

The weather application uses a range of graphics and symbols to represent different weather conditions and forecasts.

Symbol	Description
	Storm cast (dark blue) arrows indicating direction and speed of a storm.
	Wave height <ul style="list-style-type: none"> • Highest waves (red) • Intermediate waves (greens) • Lowest waves (blues)

Symbol	Description
	Canadian radar (dark greens, yellow, orange and red)
	Lightning — a lightning symbol is shown at each cloud-to-ground strike: <ul style="list-style-type: none"> • Light (recorded in last 10–15 minutes.) • Medium (recorded in last 5–10 minutes.) • Dark (recorded in last 0–5 minutes.) More recent strikes are overlaid over older symbols.
	Wind — Wind symbols show the current wind direction and strength and can be displayed as either an arrow or a wind barb. Wind arrows indicate speed — the larger the arrow, the greater (stronger) the wind speed. Wind barbs give a more precise indication of wind speed as shown in the wind speed symbols section.
	Sea surface temperature (green, yellow and orange) <ul style="list-style-type: none"> • Blue — coldest • green • yellow • orange and red — warmest
	Surface observation stations (pink) — Current or historical weather data can be viewed at surface observation stations. Not all data is available for all stations.
	Cities — The city symbols enables you to access details of city weather forecasts. Up to 3 forecasts are displayed for each city.
	NOWRad <ul style="list-style-type: none"> • Rain (green, yellow and red.) • Snow (blues) • Mixture (pinks)









Storm tracking symbols

The weather application uses a range of symbols to represent different types of storm tracks. The storm tracking function enables you to monitor significant storms in the area.

Examples of significant storms include tropical disturbances, depressions, storms and cyclones, hurricanes, typhoons, and super typhoons.

The weather map displays the track that the storm has taken, its current and forecasted position, the wind radii (current position only), direction, and speed of travel.

Storm tracks are highlighted on the weather map in the form of symbols, as shown below.







Historical (grey)	Current (red)	Forecast (orange)	Description
			Hurricane (Category 1–5)
			Tropical storm
			Tropical disturbance, tropical depression



When a symbol is selected, additional storm information can be accessed by the context menu:

- Storm's name and type.
- Date and time.
- Position, direction and speed.
- Pressure and maximum wind speed and gusts.

Surface pressure symbols





The weather application uses a range of symbols to represent different surface pressure conditions.

Symbol	Description
	High / low pressure (blue and red)
	Warm front (red)
	Cold front (blue)
	Occluded front (purple)
	Stationary front (red-blue)
	Trough (brown)
	Squall line (red)

Symbol	Description
	Dry line (red)
	Isobars (grey)





















Surface observation station symbols

The weather application uses a range of symbols to represent different types of surface observation station.

Symbol	Description
	Buoy station
	C-MAN (Coastal-marine automated network)
	WSI (Weather services international)
	NWS (National weather service)



Wind speed symbols

The weather application uses a range of symbols to represent different wind speeds.

Symbol	Speed	Symbol	Speed	Symbol	Speed
	3–7 kts		8–12 kts		13–17 kts
	18–22 kts		23–27 kts		28–32 kts
	33–37 kts		38–42 kts		43–47 kts
	48–52 kts		53–57 kts		58–62 kts
	63–67 kts		68–72 kts		73–77 kts
	78–82 kts		83–87 kts		88–92 kts
	93–97 kts		98–102 kts		etc.

Wave information symbols

The weather application uses a range of graphics and symbols to represent different types of wave information.

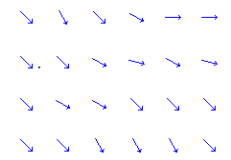
Symbol	Description
	<p>Wave height — Waves are shown in 16 shades of color from:</p> <ul style="list-style-type: none"> • Reds — Highest waves • Greens — Intermediate waves • Blues — Lowest waves
	<p>Wave period — wave periods are shown using shades of blue, the darker the shade the shorter the gap between successive waves. The wave period detail can be accessed by the context menu View Data option.</p>
	<p>Wave direction — direction of waves is indicated by blue arrows.</p>

NOWRad precipitation color codes

NOWRad displays the type and level of precipitation:

Color code	Precipitation type	Reflectivity Intensity
Light green	Rain	(15 to 19 dBz)
Medium green	Rain	(20 to 29 dBz)
Dark Green	Rain	(30 to 39 dBz)
Yellow	Rain	(40 to 44 dBz)
Orange	Rain	(45 to 49 dBz)
Light red	Rain	(50 to 54 dBz)
Dark red	Rain	(55+ dBz)
Light blue	Snow	(5 to 19 dBz)
Dark blue	Snow	(20+ dBz)
Light pink	Mixed	(5 to 19 dBz)
Dark pink	Mixed	(20+ dBz)

Canadian radar precipitation color codes

Canadian radar shows the intensity of precipitation for Canada. Unlike NOWRad, Canadian radar does not show the precipitation type.

Color code	Intensity in mm per hour
Transparent (nothing shown at very low precipitation)	0.00 to 0.20 mm/hr
Light green	0.21 to 1.00 mm/hr
Medium green	1.01 to 4.00 mm/hr

Color code	Intensity in mm per hour
Dark green	4.01 to 12.00 mm/hr
Yellow	12.01 to 24.00 mm/hr
Orange	24.01 to 50.00 mm/hr
Light red	50.01 to 100 mm/hr
Dark red	100.01+ mm/hr

Reflectivity intensity to rainfall correlation

You can use the table below to correlate reflectivity intensity in dBz to estimated rainfall in millimeters per hour or inches per hour.

Reflectivity Intensity	Rainfall (mm/hr)	Rainfall (in/hr)
5	0.0749	0.0029
10	0.1538	0.0059
15	0.3158	0.0123
20	0.6484	0.0253
25	1.332	0.0519
30	2.734	0.1066
35	5.615	0.219
40	11.53	0.4497
45	23.68	0.9235
50	48.62	1.8963
55	99.85	3.8949
60	205.05	7.9975
65	401.07	15.6424
70	864.68	33.723
75	1775.65	69.252
80	3646.33	142.21
85	7487.83	292.03
90	15376.51	599.69
95	31575.91	1231.46
100	64841.98	2528.84
105	133154.6	5193.03
110	273436.4	10664.02

Selecting weather graphics

From the weather application:

1. Select **Menu**.
2. Select **Display Graphics**.
The display graphics list is displayed.
3. Select each graphic you want to Show or Hide.
4. Selecting a graphic will switch between Show or Hide.

Note: The Wind Vector graphic options are Arrow or Barb.

26.4 Weather map navigation

You can move around the weather map and place waypoints.

When you open the weather application, a world map is displayed. If the system has a position fix for your vessel, the map will be centred on your location. As in the chart application, use the cursor to move around the map and view different locations, and the **Range Control** to zoom in and out. Use the **WPT** button to place waypoints.

Note: Waypoints are not displayed in the weather application, to view waypoints you will need to have an active chart application or radar application displayed.



Locating your vessel

The vessel icon can be repositioned to the center of the screen by following the steps below.

1. Select the Find Ship icon:  located on the left hand side of the screen.

26.5 Weather context menu

The weather application includes a context menu which provides positional data and the option to view weather reports from the cursor location.

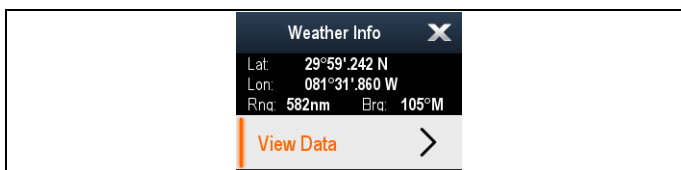

The context menu provides the following positional data for the cursor location in relation to your vessel:

- Latitude
- Longitude
- Range
- Bearing

Depending on the item or location selected on screen the context menu provides the following options:

- **View Report** — Only available when a city is selected.
- **View Data**— Not available when a city is selected.
- **View Full Report** — Only available when an observation station is selected.

Accessing the context menu

You can access the context menu by following the steps below.

1. Non-touchscreen and HybridTouch displays:
 - i. Selecting a location, object or target on-screen and pressing the **Ok** button.
2. HybridTouch and Touch only displays:
 - i. Selecting an object or target on-screen.
 - ii. Selecting and holding on a location on-screen.

26.6 Weather information

You can view weather information for:

- a specific location
- a surface observation station (when displayed)
- Cities (when displayed)

Viewing weather data at a specific location

You can view weather details at a particular location on the world map regardless of the display graphics being shown in your weather application.

From the weather application:

1. Select the location you wish to view weather details for.
The context menu is displayed.
2. Select **View Data**.
A weather information page is displayed.

Weather information page

When selecting **View Data** from the weather context menu the following information is displayed:

- Zone description
- Zone ID
- Precipitation intensity
- Precipitation type
- Sea surface temperature
- Wind speed
- Wind form
- Wave height
- Wave period
- Wave direction

Viewing weather station reports

You can view surface observation station reports by following the steps below:

From the weather application, with surface observation stations displayed:

1. Select a surface observation station.
The weather context menu is displayed.
2. Select **View Full Report**.
The station report is displayed.

Station report

Surface observation station reports contain the following information (when available)

- Station ID, name, type, bearing, time and date
- Air temperature
- Visibility
- Sea pressure
- Wind speed and form
- Sea temperature
- Wave information

Viewing city weather forecasts

You can view weather forecasts for a particular city by following the steps below:

From the weather application, with cities displayed:

1. Select a city.
The weather context menu is displayed.
2. Select **View Report**.
The City forecast is displayed. Up to 3 forecasts are shown.

26.7 Weather reports

You can view a number of different weather reports to give you a comprehensive view of the weather.

Your multifunction display shows weather reports for:

- Tropical statements.
- Marine warnings.
- Marine zone forecasts.
- Watchbox warnings.

Tropical statements

Tropical statements provide information on tropical weather conditions. This information may not be available in all areas.

Marine warnings

You can display a report for the current marine warnings in the US coastal or near shore areas, or for the zone around your vessel or cursor.

Marine zone forecasts

These forecasts cover:

- US coastal weather forecasts, offshore forecasts and high seas forecasts, or
- Great lakes forecasts and near shore forecasts, or
- Canadian coastal weather forecasts.

Watchbox warnings

When a tornado or thunderstorm warning is received within the specified alert range of your vessel, the system generates a watchbox alert. This alert provides information on the type of warning and validity period. The full watchbox report text is also displayed.

Displaying weather reports

From the weather application:

1. Select **Menu**.
2. Select **View Report**.
3. Select either **Tropical Statements**, **Marine Warnings**, **Marine Zone Forecasts**, or **Watchbox Warnings**.

The relevant report, warning, or statement is displayed.

Changing the position of forecasts on the weather map

From the weather application:

1. Select **Menu**.
2. Select **View Report**.
3. Select **Report At**.

Selecting report at will switch between reports from Ship location or Cursor location.

Note: You cannot change the position of Tropical Statements or Watchbox Warnings.

Watchbox alert box

The watchbox alert box is a red polygon which shows the location where severe weather is occurring.

The watchbox alert box shall be displayed if the weather application is displayed, watchbox alerts are On and the watchbox alert area is within the specified range from your vessel, or set to All.

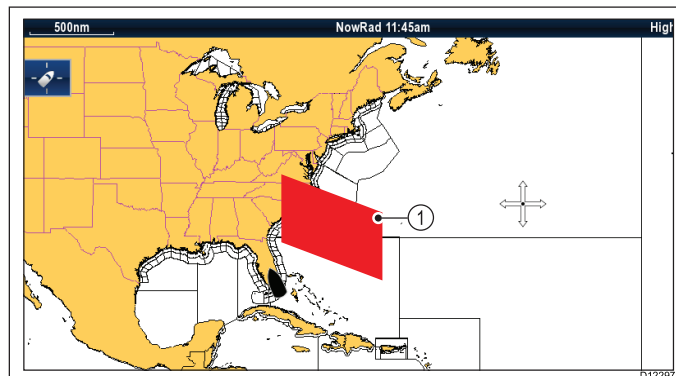

Item	Description
1	Watchbox alert box

Viewing watchbox alerts

You can view a watchbox alert at any time by following the steps below:

From the weather application with a watchbox alert box displayed.

1. Select the watchbox alert box.
The context menu is displayed.
2. Select **View Data**.
The watchbox alert message is displayed.

Setting watchbox alert range

You can specify the range from your vessel that you wish to receive watchbox alerts from.

From the weather application:

1. Select **Menu**.
2. Select **Watchbox Alerts**.
3. Select the required range, All, or Off if you do not want to receive watchbox alerts.
 - Selecting a range will display watchbox warnings occurring within the specified range.
 - Selecting All will display all watchbox warning regardless of range from your vessel.
 - Selecting Off will stop watchbox alerts.

Note: When the watchbox alert setting is set to Off watchbox reports will still be received but you will not be alerted.

26.8 Animated weather graphics

You can view animated weather graphics to provide an indication of changing weather patterns.

The animated weather option enables you to view an animation from the current time for:

- NOWRad — weather radar
- Wind
- Waves
- Pressure — surface pressure

Running a weather animation

From the weather application:

1. Select **Menu**.
2. Select **Animate Weather**.
3. Select **Animate**.
A list of animation is displayed.
4. Select the type of animation from the list.
5. Select **Play** so the On is displayed.
Selecting play will switch between on and off.

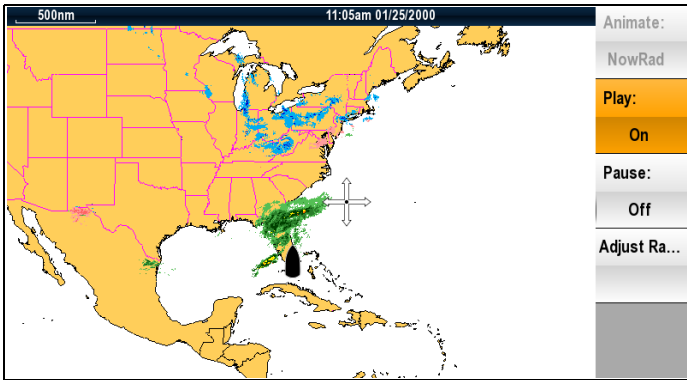

Note: You cannot display information (by moving the cursor over a symbol) when animation is running. The Range and Rotary controls do however remain operable provided the PAUSE option has not been selected. Ranging / panning will cause the animation to restart.

Note: The animation will be switched to Off if the animation menu is closed.

26.9 Weather application menu options

The following options are available from the weather application menu:

Menu item	Description	Options
Find Ship	Selecting Find Ship will reset the display to show your vessel in the center of the screen.	
Display Graphics	The Display Graphics menu allows to choose what graphics to Show or Hide in the weather application.	Display Graphics <ul style="list-style-type: none"> • Canadian Radar • Cities • Lightning • Marine Zones • NOWRad • Sea Surface Temperature • Storm Cast • Storm Tracks • Surface Pressure • Surface Observation Stations • Wind • Wind Vector — Arrow or Barb • Watchbox • Wave Height • Wave Period • Wave Direction
Animate Weather	The Animate Weather menu contains the following sub-menus: <ul style="list-style-type: none"> • Animate • Play • Pause • Adjust Range 	Animate: <ul style="list-style-type: none"> • NOWRad • Wind • Wave • Pressure Play: <ul style="list-style-type: none"> • On • Off Pause: <ul style="list-style-type: none"> • On • Off Adjust Range Adjust Range allows you to use the Range

Menu item	Description	Options
		Control to zoom in and out.
View Report	The View Report menu allows you to view the different types of weather reports received. You can also select the location of the report.	Report At <ul style="list-style-type: none"> • Ship • Cursor View Report <ul style="list-style-type: none"> • Tropical Statements • Marine Warnings • Marine Zone Forecasts • Watchbox Warnings
Watchbox Alert	The Watchbox Alerts menu allows you to turn alerts Off, or select a range.	Alert Range <ul style="list-style-type: none"> • Off • 50 nm • 150 nm • 300 nm • 500 nm • All <div style="border: 1px solid black; padding: 5px; margin-top: 10px;"> Note: Unit of measurement is dependant upon unit set-up choices. </div>
Data Overlay Set-up	Allows you to set up and display/hide up to 2 data cells in the bottom left corner of the screen: <ul style="list-style-type: none"> • Data Cell 1 • Select Data Category • Data Cell 2 • Select Data Category 	Data Cell 1 <ul style="list-style-type: none"> • On • Off Select Data Category Allows selection of a data type by category. Data Cell 2 <ul style="list-style-type: none"> • On • Off Select Data Category Allows selection of a data type by category.
Sirius User ID	This option will display your registered Sirius User ID.	

26.10 Glossary of weather terms

Term	Definition
Cold front	The boundary between two different air masses where cold air pushes warm air out of the way and brings colder weather.
Cyclone	A large area of low atmospheric pressure, characterized by inward spiralling winds. A "low" also called a "depression". Also the name used for a hurricane in the Indian Ocean and Western Pacific.
Depression	An area of low pressure. Also called a cyclone.
Dry line	A region where there is a strong gradient in dew point temperatures. It is often found in a region where strong thunderstorms develop.
Forecast	Something that tells us what the weather is probably going to be like.
Front	The boundary between two masses of air with different temperatures (i.e. a mass of cold air and a mass of warm air).
High	Also known as an 'anticyclone' an area of high atmospheric pressure with a system of winds rotating outwards. This usually means dry weather. It is the opposite of a 'low'.
High Pressure	A mass of air that presses down strongly on the surface of the Earth because it is being cooled and is therefore more dense.
Hurricane	<p>A violent, spiralling storm that forms over the Atlantic Ocean, with winds over 120 kph. Such storms usually have a lifespan of several days. Also known as a typhoon or tropical cyclone. There are 5 levels of hurricane:</p> <ul style="list-style-type: none"> Category 1— Winds 74–95 mph (64–82 kt or 119–153 km/hr). Storm surge generally 4–5 ft above normal. No real damage to building structures. Damage primarily to unanchored mobile homes, shrubbery, and trees. Some damage to poorly constructed signs. Also, some coastal road flooding and minor pier damage. Category 2 — Winds 96–110 mph (83–95 kt or 154–177 km/hr). Storm surge generally 6–8 feet above normal. Some roofing material, door, and window damage of buildings. Considerable damage to shrubbery and trees with some trees blown down. Considerable damage to mobile homes, poorly constructed signs, and piers. Coastal and low lying escape routes flood 2–4 hours before arrival of the hurricane centre Small craft in unprotected anchorages break moorings. Category 3 — Winds 111–130 mph (96–113 kt or 178–209 km/hr). Storm surge generally 9–12 ft above normal. Some structural damage to small residences and utility buildings with a minor amount of curtain wall failures. Damage to shrubbery and trees with foliage blown off trees and large trees blown down. Mobile homes and poorly constructed signs are destroyed. Low lying escape routes are cut by rising water 3–5 hours before arrival of the centre of the hurricane. Flooding near the coast destroys smaller structures with larger structures damaged by battering from floating debris. Terrain continuously lower than 5 ft above mean sea level may be flooded inland 8 miles (13 km) or more. Evacuation of low lying residences with several blocks of the shoreline may be required. Category 4 — Winds 131–155 mph (114–135 kt or 210–249 km/hr). Storm surge generally 13–18 ft above normal. More extensive curtain wall failures with some complete roof structure failures on small residences. Shrubs, trees, and all signs are blown down. Complete destruction of mobile homes. Extensive damage to doors and windows. Low lying escape routes may be cut by rising water 3–5 hours before arrival of the centre of the hurricane. Major damage to lower floors of structures near the shore. Terrain lower than 10 ft above sea level may be flooded requiring massive evacuation of residential areas as far inland as 6 miles (10 km). Category 5 — Winds greater than 155 mph (135 kt or 249 km/hr). Storm surge generally greater than 18 ft above normal. Complete roof failure on many residences and industrial buildings. Some complete building failures with small utility buildings blown over or away. All shrubs, trees, and signs blown down. Complete destruction of mobile homes. Severe and extensive window and door damage. Low lying escape routes are cut by rising water 3–5 hours before arrival of the centre of the hurricane. Major damage to lower floors of all structures located less than 15 ft above sea level and within 500 yards of the shoreline. Massive evacuation of residential areas on low ground within 5–10 miles (8–16 km) of the shoreline may be required.
Isobar	A line on a weather map linking areas with equal air pressure.
Lightning	Discharge of static electricity in the atmosphere, usually between the ground and a storm cloud.
Low	Also called a 'depression' this region of low pressure can mean wet weather.
Low Pressure	A mass of air that presses down only weakly on the surface of the Earth's surface as it is warmed and it therefore less dense.
Millibar	A unit used to measure atmospheric pressure.
Occluded Front	An area where warm air is pushed upwards as a cold front overtakes a warm front and pushes underneath it.

Term	Definition
Precipitation	Moisture that is released from the atmosphere as rain, drizzle, hail, sleet or snow, as well as dew and fog.
Pressure Centre	A region of high or low pressure.
Squall line	A non-frontal band, or line, of thunderstorms.
Super typhoon	A typhoon that reaches maximum sustained 1 minute surface winds of at least 65 m/s (130 kt, 150 mph). This is the equivalent of a strong category 4 or 5 hurricane in the Atlantic basin or a category 5 severe tropical cyclone in the Australian basin.
Tornado	A funnel shaped whirlwind which extends to the ground from storm clouds.
Tropical cyclone	A low pressure system that generally forms in the tropics. The cyclone is accompanied by thunderstorms and, in the Northern Hemisphere, a counterclockwise circulation of winds near the earth's surface.
Tropical depression	An organized system of clouds and thunderstorms with a defined surface circulation and maximum sustained winds of 38 mph (33 kt) or less.
Tropical storm	An organized system of strong thunderstorms with a defined surface circulation and maximum sustained winds of 39-73 mph (34-63 kt).
Tropics	An area on the Earth's surface that lies between 30° north and 30° south of the equator.
Trough	An elongated area of relatively low atmospheric pressure, usually extending from the centre of a low pressure region.
Typhoon	The name for a tropical storm originating in the Pacific Ocean, usually the China Sea. They are basically the same as the hurricanes of the Atlantic Ocean and the cyclones of the Bay of Bengal.
Wave cyclone	A storm or low pressure centre that moves along a front.
Wave period	The period is the time gap between successive waves and the longer the period the faster the waves travel.

Chapter 27: Sirius audio application (North America only)

Chapter contents

- [27.1 Sirius audio overview on page 386](#)

27.1 Sirius audio overview

A connected, compatible Raymarine Sirius marine weather / satellite radio receiver can be controlled using the Sirius audio application.

Note: A Sirius subscription is required to enable use of a Sirius marine weather / satellite radio receiver.

To enable volume controls the Raymarine Sirius marine weather / satellite radio receiver also needs to be connected to a vessel entertainment system. Volume control is achieved using a combination of the multifunction display controls and the vessel entertainment system controls.

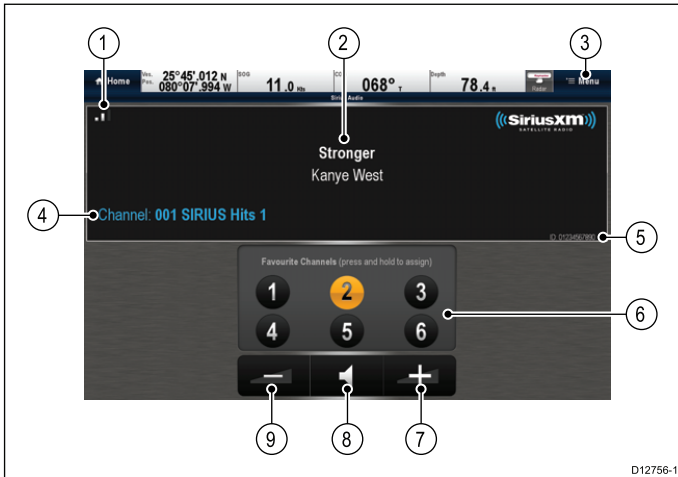

1	Signal strength (Between 0 and 3 bars).
2	Track name and Artist name.
3	Menu — The menu is used to browse available satellite radio channels.
4	Station details.
5	Sirius receiver ID.
6	Favorite channels.
7	Volume up.
8	Mute / Unmute.
9	Volume down.

The Sirius audio application can be used to:

- Browse available radio channels.
- Switch radio channel.
- Assign channels as favorites.
- Change the volume level.
- Mute the volume.

Note: Sirius satellite radio is only available in North America.

Accessing the Sirius audio application

1. Select the **Sirius Audio** page icon from the homescreen.

Changing the channel

You can view a list of available satellite radio channels and select the station you want to listen to.

From the Sirius Audio application:

1. Select **Menu**.
2. Select **Select channel**.
The Channel browser is displayed.



3. Select the relevant channel from the list.

Adding favorites

You can programme up to 6 favorite channels in the Sirius audio application. To save the current channel as a favorite follow the steps below.

1. Switch to the channel you want to save as a favorite.
2. When the channel is displayed onscreen select and hold on a favorite channel number (1 to 6) for 2 seconds.

The radio channel is now assigned as a favorite.

Using the volume controls

The Sirius audio application can be used to control the volume of your Sirius audio receiver.

With the Sirius audio application displayed:

1. Select the **Volume up** or **Volume down** icon to change the volume level, or
2. Select the **Mute icon** to mute and un-mute the audio.

Chapter 28: Mobile applications

Chapter contents

- [28.1 Raymarine mobile apps on page 388](#)
- [28.2 Enabling Wi-Fi on page 389](#)
- [28.3 Enabling mobile apps on page 389](#)
- [28.4 Setting up Wi-Fi security on page 390](#)
- [28.5 Selecting a Wi-Fi channel on page 390](#)

28.1 Raymarine mobile apps

Raymarine mobile apps enable viewing and control of your multifunction display via a compatible mobile device, using a Wi-Fi connection.

Raymarine currently offers the following mobile apps:

- **RayView**
- **RayRemote**
- **RayControl**

Note: Your multifunction display must have software version V3.15 or later in order to use mobile apps.

RayView

This app enables you to stream what you see on your multifunction display to a compatible smartphone or tablet device, using a Wi-Fi connection.

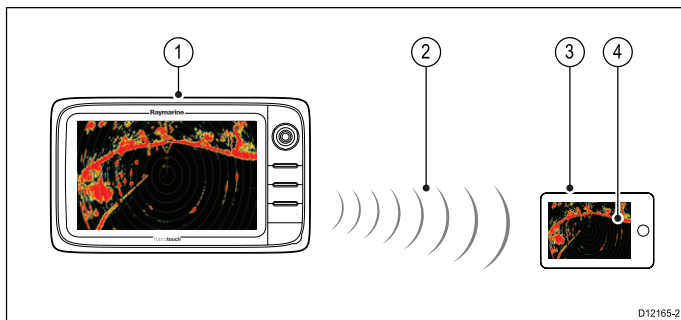

1. Multifunction display.
2. Wi-Fi connection (1 way – streaming only).
3. Compatible device.
4. “RayView” video streaming app.

RayControl

— This app enables you to stream and remotely control your multifunction display from a compatible tablet device, using a Wi-Fi connection.

Note: For safety reasons pilot controls and power button options are not available remotely.

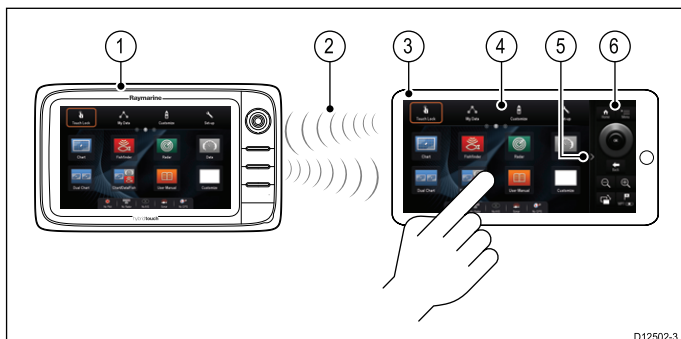

1. Multifunction display.
2. Wi-Fi connection (2 way – streaming and remote control).
3. Compatible tablet.
4. “RayControl” streaming and remote control app.
5. “RayControl” controls access (Touch the arrow to access controls).

6. “RayControl” remote controls

RayRemote

This app enables you to stream or control your multifunction display remotely from a compatible smartphone, using a Wi-Fi connection.

Note: RayRemote is able to switch between displaying the remote controls or the video stream.

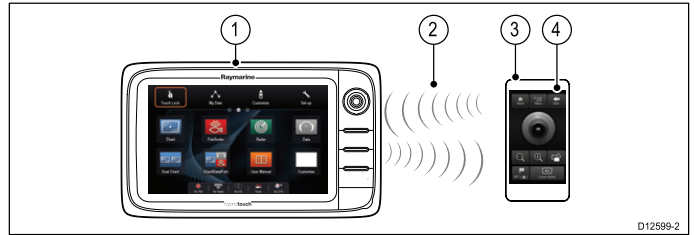

1. Multifunction display.
2. Wi-Fi connection (2 way – streaming or remote control).
3. Compatible smartphone.
4. RayRemote app

To use Raymarine mobile apps you must first:

- Download and install the required app from the relevant app store.
- Enable Wi-Fi in the System Settings on the multifunction display.
- Enable Wi-Fi on your compatible device.
- Select the Raymarine Wi-Fi connection from the list of available Wi-Fi networks on your compatible device.
- Enable the relevant type of connection (i.e. Viewing or Remote Control) in the System Settings on the multifunction display.

Mobile app compatibility

The Raymarine mobile apps are compatible with the following devices.

Device	Operating system
iPhone 4 or later	iOS
iPad 2 or later	iOS
Android smartphone	Android V2.2.2 or greater with 1GHz or greater processor
Android tablet	Android V2.2.2 or greater with 1GHz or greater processor
Kindle Fire	Android \ amazon

28.2 Enabling Wi-Fi

With the homescreen displayed:

1. Select **Set-up**.
2. Select **System Settings**.
3. Select **Wireless Connections**.
4. Select **Wi-Fi > ON**.

28.3 Enabling mobile apps

Raymarine mobile apps must be enabled on your multifunction display before you can stream video or remote control your multifunction display via a tablet or smartphone device.

With the homescreen displayed:

1. Select **Set-up**.
2. Select **System Settings**.
3. Select **Wireless Connections**.
4. Select **Mobile apps**.
5. Select **Viewing only** to enable video streaming only, or
6. Select **Remote Control** to enable remote control and video streaming using.
7. Launch the relevant Raymarine mobile app on your tablet or smartphone device and follow the on-screen instructions.

28.4 Setting up Wi-Fi security

You can encrypt the Wi-Fi connection on the multifunction display to prevent unauthorized devices from accessing the connection. The default encryption is WPA2.

With the homescreen displayed:

1. Select **Set-up**.
2. Select **System Settings**.
3. Select **Wireless Connections**.
4. Select **Wi-Fi > On**.
5. Select **Wi-Fi Name** and specify the SSID. This should be a memorable word and must be unique to each multifunction display in your system.

By default the SSID is the serial number of the multifunction display.

6. Select **Wi-Fi Security** and specify the type of encryption you want to use — None, WPA only, WPA2 only (default), or WPA/WPA2.

Note:

- Raymarine strongly recommends the use of the **WPA2** security setting.
- Selecting **None** for your Wi-Fi Security will leave your Wi-Fi open and allow anyone with a Wi-Fi enabled device access to your system.

7. It is recommended that the default **Wi-Fi Passphrase** is NOT changed.

Note: Once Wi-Fi security is set up on the multifunction display you must specify the same SSID and password credentials on your iPhone or iPad before wireless video streaming can be used.

Changing the default passphrase

It is recommended that the default passphrase is not changed, however if you do need to change the passphrase follow the steps below:

From the Wireless Connections menu: **Set-up > System Settings > Wireless Connections**

1. Select **Wi-Fi Passphrase**.
The on-screen keyboard will be displayed, showing the current passphrase.
2. Use **DEL** to delete the current passphrase.
3. Enter a new passphrase.

Note: Ensure the passphrase you choose is 'strong' by using a combination of upper/lower case letters, numbers and special characters. The passphrase can be between 8 and 63 characters in length with longer passphrases being more secure.

4. Select **SAVE** to save the new passphrase.

28.5 Selecting a Wi-Fi channel

By default the multifunction display automatically selects an available Wi-Fi channel. If you're experiencing difficulties with wireless video streaming it may be necessary to manually specify a Wi-Fi channel for both the multifunction display and the device you want to stream video to.

With the homescreen displayed:

1. Select **Set-up**.
2. Select **System Settings**.
3. Select **Wireless Connections**.
4. Select **Wi-Fi > On**.
5. Select **Wi-Fi Channel**.
6. Select one of the listed channels.

Chapter 29: Maintaining your display

Chapter contents

- [29.1 Service and maintenance on page 392](#)
- [29.2 Product cleaning on page 392](#)

29.1 Service and maintenance

This product contains no user serviceable components. Please refer all maintenance and repair to authorized Raymarine dealers. Unauthorized repair may affect your warranty.

Routine equipment checks

Raymarine strongly recommends that you complete a number of routine checks to ensure the correct and reliable operation of your equipment.

Complete the following checks on a regular basis:

- Examine all cables for signs of damage or wear and tear.
- Check that all cables are securely connected.

29.2 Product cleaning

Best cleaning practices.

When cleaning products:

- If your product includes a display screen, do NOT wipe the screen with a dry cloth, as this could scratch the screen coating.
- Do NOT use abrasive, or acid or ammonia based products.
- Do NOT use a jet wash.

Cleaning the display case

The display unit is a sealed unit and does not require regular cleaning. If it is necessary to clean the unit, follow this basic procedure:

1. Switch off the power to the display.
2. Wipe the display with a clean, soft cloth (a microfibre cloth is ideal).
3. If necessary, use a mild detergent to remove grease marks.

Note: Do NOT use solvents or detergents on the screen itself.

Note: In certain conditions, condensation may appear inside the display screen. This will not harm the unit, and can be cleared by powering on the display for a short time.

Cleaning the display screen

A coating is applied to the display screen. This makes it water repellent, and prevents glare. To avoid damaging this coating, follow this procedure:

1. Switch off the power to the display.
2. Rinse the screen with fresh water to remove all dirt particles and salt deposits.
3. Allow the screen to dry naturally.
4. If any smears remain, very gently wipe the screen with a clean microfibre cleaning cloth (available from an opticians).

Cleaning the sun cover

The supplied sun cover features an adhesive surface. In certain conditions unwanted contaminants may stick to this surface. To avoid damaging the monitor display, clean the sun cover regularly following this procedure:

1. Carefully remove the sun cover from the display.
2. Rinse the sun cover with fresh water to remove all dirt particles and salt deposits.
3. Allow the sun cover to dry naturally.

Chapter 30: Troubleshooting

Chapter contents

- 30.1 Troubleshooting on page 394
- 30.2 Power up troubleshooting on page 395
- 30.3 Radar troubleshooting on page 396
- 30.4 GPS troubleshooting on page 397
- 30.5 Troubleshooting **Autorouting** on page 398
- 30.6 Sonar troubleshooting on page 400
- 30.7 Sonar crosstalk interference on page 401
- 30.8 Thermal camera troubleshooting on page 403
- 30.9 System data troubleshooting on page 405
- 30.10 Video troubleshooting on page 406
- 30.11 Wi-Fi troubleshooting on page 407
- 30.12 Bluetooth troubleshooting on page 408
- 30.13 Touchscreen troubleshooting on page 409
- 30.14 Miscellaneous troubleshooting on page 410

30.1 Troubleshooting

The troubleshooting information provides possible causes and corrective action required for common problems associated with marine electronics installations.

All Raymarine products are, prior to packing and shipping, subjected to comprehensive test and quality assurance programs. However, if you experience problems with the operation of your product this section will help you to diagnose and correct problems in order to restore normal operation.

If after referring to this section you are still having problems with your unit, please contact Raymarine Technical Support for further advice.

30.2 Power up troubleshooting

Problems at power up and their possible causes and solutions are described here.

Problem	Possible causes	Possible solutions
The system (or part of it) does not start up.	Power supply problem.	Check relevant fuses and breakers.
		Check that the power supply cable is sound and that all connections are tight and free from corrosion.
		Check that the power source is of the correct voltage and sufficient current.

30.3 Radar troubleshooting

Problems with the radar and their possible causes and solutions are described here.

Problem	Possible causes	Possible solutions
No Data or No scanner message	Radar scanner power supply	Check that the scanner power supply cable is sound and that all connections are tight and free from corrosion.
		Check relevant fuses and breakers.
		Check power source is of the correct voltage and sufficient current (using voltage booster if appropriate).
	SeaTalk ^{hs} / RayNet network problem	Check that the Scanner is correctly connected to a Raymarine network switch or SeaTalk ^{hs} crossover coupler (as applicable).
		Check the status of the Raymarine network switch.
		Check that SeaTalk ^{hs} / RayNet cables are free from damage.
	Software mismatch between equipment may prevent communication.	Contact Raymarine technical support.
Switch at scanner pedestal in OFF position	Ensure scanner pedestal switch is in ON position.	
Radar will not initialize (Voltage control module (VCM) stuck in "sleep mode")	Intermittent or poor power connection	Check power connection at VCM. (Voltage at input = 12 / 24 V, Voltage at output = 40 V)
The bearing of a target on the radar screen is incorrect.	The radar bearing alignment requires correcting.	Check and adjust radar bearing alignment.

30.4 GPS troubleshooting

Problems with the GPS and their possible causes and solutions are described here.

Problem	Possible causes	Possible solutions
"No Fix" GPS status icon is displayed.	Geographic location or prevailing conditions preventing satellite fix.	Check periodically to see if a fix is obtained in better conditions or another geographic location.
	GPS connection fault.	Ensure that external GPS connections and cabling are correct and fault free.
	External GPS antenna in poor position. For example: <ul style="list-style-type: none">• Below decks.• Close proximity to transmitting equipment such as VHF radio.	Ensure GPS antenna has a clear view of the sky.
	GPS installation problem.	Refer to the installation instructions.

Note: A GPS Status screen is available within the display. This provides satellite signal strength and other relevant information.

30.5 Troubleshooting Autorouting

The information below details the warnings that can be displayed when using **Autorouting**, a description of what the warning means and actions to be taken to correct the issue.

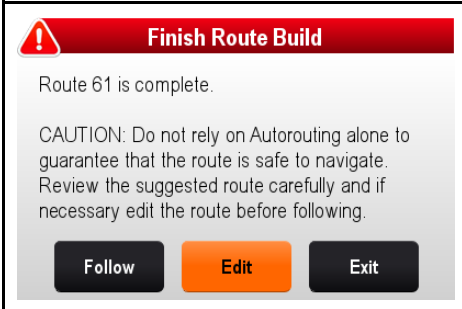
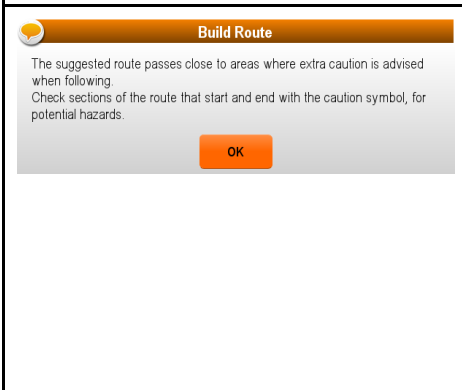
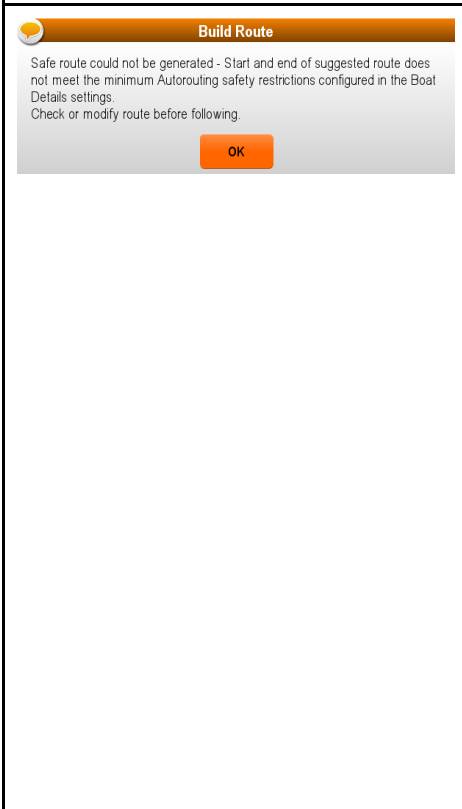
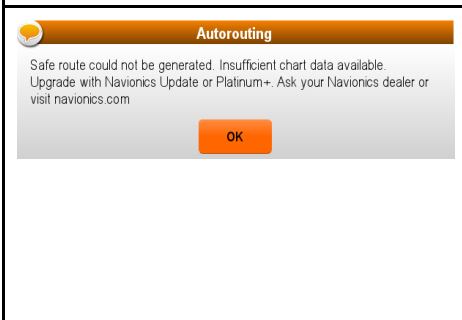
Warning message	Description	Resolution
 <p>Finish Route Build</p> <p>Route 61 is complete.</p> <p>CAUTION: Do not rely on Autorouting alone to guarantee that the route is safe to navigate. Review the suggested route carefully and if necessary edit the route before following.</p> <p>Follow Edit Exit</p>	<p>Autorouting has completed successfully</p>	<p>The Route maybe followed AFTER it has been reviewed to ensure that the generated route is safe for your vessel to follow.</p>
 <p>Build Route</p> <p>The suggested route passes close to areas where extra caution is advised when following. Check sections of the route that start and end with the caution symbol, for potential hazards.</p> <p>OK</p>	<p>Autorouting has completed successfully, however the route passes close to areas where extra caution is advised (e.g. a charted buoy). The caution areas will be between waypoints that have been assigned caution symbol.</p>	<p>The route must be reviewed as follows:</p> <ul style="list-style-type: none"> Identify any waypoints using the caution symbol (these will be in sets of 2), check between the caution symbols to identify the reason for the caution. If possible move the waypoint(s) to avoid the hazard. Review all route legs and their waypoints to ensure appropriate before following the route.
 <p>Build Route</p> <p>Safe route could not be generated - Start and end of suggested route does not meet the minimum Autorouting safety restrictions configured in the Boat Details settings. Check or modify route before following.</p> <p>OK</p>	<p>The start and or end point of the route does not meet the minimum safe values specified in the Boat Details settings. The start and end waypoints will be created and joined with a straight route leg, however there will be no automatically generated waypoints and the waypoint symbols will be changed to caution symbols.</p>	<p>Perform the following checks:</p> <ul style="list-style-type: none"> Check that the values specified in the Boat Details settings are correct. Using the context menu check the Chart Objects menu at the exact location of the start and or end points to establish if the Depth range min value meets you Minimum Safe Depth. <div style="border: 1px solid black; padding: 5px;"> <p>Note:</p> <ul style="list-style-type: none"> If no minimum value for depth is available at the desired location Autorouting will assume a minimum depth of 0 feet. Autorouting adds its own safety margin of 0.8 m or 20% of the specified Minimum Safe Depth which ever is greater. </div> <ul style="list-style-type: none"> Check for any other hazards that would prevent Autorouting from generating a route.
 <p>Autorouting</p> <p>Safe route could not be generated. Insufficient chart data available. Upgrade with Navionics Update or Platinum+. Ask your Navionics dealer or visit navionics.com</p> <p>OK</p>	<p>There is insufficient data available on the cartography to generate the route, The start and end waypoints will be created, however there will be no automatically generated waypoints and the waypoint symbols will be changed to caution symbols.</p>	<ul style="list-style-type: none"> Insert compatible cartography (Navionics® Updates or Navionics® Platinum™+) Update existing cartography <div style="border: 1px solid black; padding: 5px;"> <p>Note: There may be certain areas where sufficient details are not yet available even on the latest cartography.</p> </div>

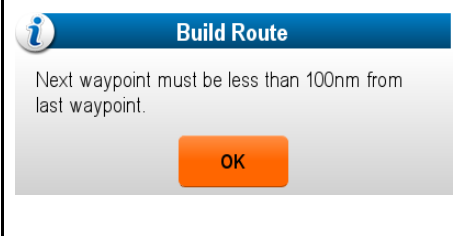
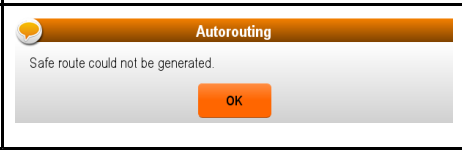
Warning message	Description	Resolution
 <p>The screenshot shows a blue header bar with an information icon and the text "Build Route". Below the header, the message reads: "Next waypoint must be less than 100nm from last waypoint." At the bottom of the message box is an orange "OK" button.</p>	<p>The start and end point of the desired route are further than 100 nm apart.</p>	<p>Create smaller route legs. e.g. instead of trying to create a route from point A to point B, create a route from point A to point B to point C to point D, this will enable a route longer than 100 nm to be created using Autrouting for each route leg.</p>
 <p>The screenshot shows an orange header bar with a warning icon and the text "Autrouting". Below the header, the message reads: "Safe route could not be generated." At the bottom of the message box is an orange "OK" button.</p>	<p>A safe route could not be generated The first waypoint will be placed but the end waypoint will not.</p>	<p>Check the chart area along the expected route to identify areas which cannot be navigated through due to obstacles or land mass.</p>

30.6 Sonar troubleshooting

Problems with the sonar and their possible causes and solutions are described here.

Problem	Possible causes	Possible solutions
Sonar data not available on multifunction display.	Unit power supply fault.	Check the unit power supply and cables.
	Other unit fault.	Refer to the instructions supplied with the unit.
	SeaTalk ^{hs} / RayNet network problem.	Check that the unit is correctly connected to a Raymarine network switch. If a crossover coupler or other coupler cable / adapter is used, check all connections (as applicable).
		Check the status of the Raymarine network switch (if applicable).
		Check that SeaTalk ^{hs} / RayNet cables are free from damage.
Software mismatch between equipment may prevent communication.	Contact Raymarine technical support.	
Problematic data readings. Note: Not all transducers and / or sonar modules support the detection of depth, range and temperature. For more information, refer to the latest specifications and documentation available for your particular products on the Raymarine website (www.raymarine.com).	Gain or Frequency settings may be inappropriate for present conditions.	Check the sonar presets, gain and frequency settings.
	Unit power supply fault.	Check the voltage from the power supply, if this is too low it can affect the transmitting power of the unit.
	Unit cable fault.	Ensure that the power, transducer and all other cables to the unit are properly connected and free from damage.
	Transducer fault.	Check that the transducer is mounted correctly and is clean.
		If you have a transom mount transducer, check that the transducer hasn't kicked-up due to hitting an object.
	Other unit fault.	Refer to the instructions supplied with the unit.
	Vessel stationary.	Fish arches are not displayed if the vessel is stationary; fish will appear on the display as straight lines.
	High vessel speed	Turbulence around the transducer may be confusing the unit.
	Scroll speed set to zero	Adjust the scroll speed.
Incorrect speed reading (DST)	Paddle wheel fault	Check that the paddle wheel is clean.
	No speed offset set	Add speed offset.
	Incorrect calibration	Re-calibrate equipment
	Transducer does not have a speed element	Install transducer with speed element to enable speed readings.

30.7 Sonar crosstalk interference

There are 2 types of potential sonar crosstalk interference in a Raymarine sonar system:

1. **SideVision** sonar crosstalk interference
2. Multiple sonar crosstalk interference

The types of crosstalk interference that you may experience in your system depend on the combination and type of sonar equipment installed, and the way in which the equipment has been installed.

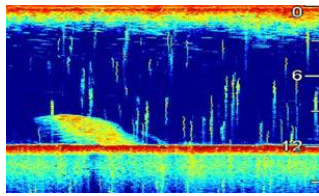
SideVision sonar crosstalk interference	Multiple sonar crosstalk interference
	
<p>Due to the high sensitivity of SideVision transducers, you may experience some minor crosstalk interference between the left and right receiving channels in areas of strong target returns. Examples of strong target returns include solid objects such as underwater bridge structure. This interference shows up in the Fishfinder application as subtle reflections from the right sonar image displayed in the left sonar image, or vice versa.</p>	<p>When using multiple sonar modules and transducers operating in overlapping frequency ranges, you may experience some crosstalk interference between the ranges. This interference is displayed in the Fishfinder application as vertical "rain drops" throughout the water column. These vertical "rain drops" indicate that 2 sonar modules are operating in close frequency proximity to one another.</p>

SideVision sonar crosstalk interference

Crosstalk interference is expected behavior in a high sensitivity device such as a **SideVision** transducer, and is not indicative of a fault with your transducer or sonar module.

Reducing multiple sonar crosstalk interference

Crosstalk interference in systems with multiple sonar modules and transducers is the result of a number of factors, including installation, operation, and environment.

- **Choose an equipment combination that minimizes overlapping frequencies.** Wherever possible, choose to use sonar modules and transducers that operate in different frequency ranges ("Channels"), for example CP100 and CP300 sonar modules and CPT-100 and B744V transducers. This will help to ensure that each component is operating in a distinct relative frequency range – for example, a "high" frequency range for the CP100 and a "low" frequency range for the CP300.
- **Only use the sonar channels that you really need.** Although it is possible to run multiple sonar

modules simultaneously in a Raymarine system, it may not always be necessary to do so. If you are in a scenario that requires only one sonar module to be active at a time, disable any other sonar modules by changing the Fishfinder application pane to a single one which only displays the output from one sonar module. Alternatively, disable the ping for any unused sonar modules by selecting **MENU > Channel > Ping > OFF** in the Fishfinder application.

- **Identify the sonar module and transducer that is causing the interference.** To do this, disable the ping or remove the power for one of the sonar modules in your system. If the interference in the Fishfinder application disappears immediately, you now know which device is causing the interference. If the interference doesn't disappear, repeat the exercise again with the other sonar module(s) in your system, one at a time. Once you know which device is causing the interference, proceed with the following methods to reduce the interference from the relevant device.
- **Adjust the Interference Rejection Filter.** The default setting for all Raymarine MFDs is "Auto". Changing this setting to "High" might help to reduce interference (**MENU > Setup > Sounder Setup > Interference Rejection**). Note that the Interference Rejection Filter setting is not available for all sonar modules.
- **Decrease the power output of the interfering transducer.** Adjusting the "Power Mode" in the Sensitivity Settings in the MFD's Fishfinder application can help to minimize the presence of crosstalk interference (**MENU > Sensitivity Settings > Power Mode**). Note that the Power Mode setting is not available for all transducers.
- **Ensure that you have a common RF ground point for all electrical equipment on your vessel.** On vessels without an RF ground system, ensure all product drain wires (where available) are connected directly to the negative battery terminal. Ineffective RF grounding can cause electrical interference which may in turn result in sonar crosstalk interference.
- **Increase the physical distance between your sonar modules.** Electrical interference may be occurring between a cable on one sonar module, and a cable on a different sonar module. Ensure that your sonar modules are physically located as far away from each other as possible.
- **Increase the physical distance between your sonar transducers.** Electrical and / or acoustic interference may be occurring between the different transducers in your system. Ensure that your transducers are physically located as far away from each other as possible.

Note: Given the effort and potential difficulties involved in relocating sonar equipment, it should only be considered as a last resort when you judge the interference to be a significant problem which cannot be resolved using the methods described above.

Note: Due to physical size and other constraints that vary from vessel to vessel, it may not be possible to completely eliminate crosstalk interference from your system. However, this will not impede your ability to benefit from the full capabilities of your sonar system. Being able to easily identify the way in which interference is displayed in the Fishfinder application can sometimes be the best and easiest route to dealing with it.

30.8 Thermal camera troubleshooting

Problems with the thermal camera and their possible causes and solutions are described here.

Problem	Possible causes	Possible solutions
Video not displayed.	Camera is in Standby mode.	The camera will not display video if it is in Standby mode. Use the camera controls (either the thermal camera application or JCU) to “wake” the camera from standby.
	Problem with the thermal camera video connections.	<ul style="list-style-type: none"> • Check thermal camera video cables are sound and properly connected. • Ensure that the video is connected into video input 1 at the multifunction display or GVM. • Ensure that the correct video input is selected at the display.
	Problem with power supply to the camera or JCU (if used as the primary controller)	<ul style="list-style-type: none"> • Check the power connections to the camera and JCU / PoE injector (if used). • Ensure that the power switch / breaker is on. • Check the fuse / breaker state.
Cannot control thermal camera from Raymarine display or keyboard.	Thermal camera application is not running.	Ensure the thermal camera application is running on the multifunction display (as oppose to the video application which does not have camera controls).
Erratic or unresponsive controls.	Network problem.	Check that the controller and thermal camera are correctly connected to the network. (Note: This may be a direct connection or via a Raymarine network switch.)
		Check the status of the Raymarine network switch.
		Check that SeaTalk ^{hs} / RayNet cables are free from damage.
	Control conflict, e.g. caused by multiple users at different stations.	Ensure that no other controllers are in use at the same time.
	Problem with the controller.	Check power / network cabling to the controller and PoE injector (PoE only used with optional Joystick Control Unit). Check other controllers if available. If other controllers are operating this will eliminate the possibility of a more fundamental camera fault.
Cannot switch between thermal and visible (VIS / IR) video image .	Camera is not a dual payload model.	Only “dual payload” (dual lens) thermal cameras support VIS / IR switching.
	VIS / IR cable not connected.	Ensure that the VIS / IR cable is connected from the camera to the Raymarine system. (The IR-only cable does not support switching).
Noisy image.	Poor quality or faulty video cable.	Ensure that the video cable is no longer than necessary. The longer the cable is (or the smaller the wire gauge / thickness), the more severe the losses become. Use only high quality shielded cable suitable for a marine environment.
	Cable is picking up electromagnetic interference (EMI) from another device.	<ul style="list-style-type: none"> • Ensure you are using a high quality shielded cable. • Ensure proper cable separation, for example do not run data and power cables in close proximity with each other.

Problem	Possible causes	Possible solutions
Image too dark or too light.	Display brightness is set too low.	Use the brightness controls at the display to adjust accordingly.
	The contrast or brightness settings in the thermal camera application are set too low.	Use the appropriate menu in the thermal camera application to adjust the contrast and brightness of the image.
	The Scene Mode is not appropriate for the current conditions.	A particular environment may benefit from a different Scene Mode setting. For example, a very cold background (such as the sky) could cause the camera to use a wider temperature range than appropriate. Use the SCENE button.
Image freezes momentarily.	FFC (Flat Field Correction).	The image will pause momentarily on a periodic basis during the Flat Field Correction (FFC) cycle. Just prior to the FFC, a small green square will appear in the upper left corner of the screen.
Image is inverted (upside down).	Camera “Ball down” setting is incorrect.	Ensure that the Ball down setting within the thermal camera system setup menu is set correctly.

30.9 System data troubleshooting

Aspects of the installation can cause problems with the data shared between connected equipment. Such problems, their possible causes and solutions are described here.

Problem	Possible causes	Possible solutions
Instrument, engine or other system data is unavailable at all displays.	Data is not being received at the display.	Check the data bus (e.g. SeaTalk ^{ng}) wiring and connections.
		Check the overall integrity of the data bus (e.g. SeaTalk ^{ng}) wiring.
		If available refer to the reference guide for the data bus (e.g. SeaTalk ^{ng} reference manual).
	Data source (e.g. ST70 instrument or engine interface) is not operating.	Check the source of the missing data (e.g. ST70 instrument or engine interface).
		Check the power to the SeaTalk bus.
		Refer to the manufacturer's handbook for the equipment in question.
Software mismatch between equipment may prevent communication.	Contact Raymarine technical support.	
Instrument or other system data is missing from some but not all displays.	Network problem.	Check that all required equipment is connected to the network.
		Check the status of the Raymarine network Switch.
		Check that SeaTalk ^{hs} / RayNet cables are free from damage.
	Software mismatch between equipment may prevent communication.	Contact Raymarine technical support.

30.10 Video troubleshooting

Problems with the video inputs and their possible causes and solutions are described here.

Problem	Possible causes	Possible solutions
No signal message on screen (video image not displayed)	Cable or connection fault	Check that the connections are sound and free from corrosion.

30.11 Wi-Fi troubleshooting

Aspects of the installation can cause problems with the data shared between wireless devices. Such problems, their possible causes and solutions are described here.

Problem	Possible causes	Possible solutions
No wireless connection.	Tablet / smartphone does not have a wireless connection established with the multifunction display.	Ensure that Wi-Fi is enabled on the multifunction display (Homescreen: > Set-Up > System Settings > Wireless Connections > Wi-Fi > On).
		Ensure that the "Wi-Fi" option is enabled on the iPhone (available from the phone's Settings menu).
		Ensure that the Raymarine connection is selected as the Wi-Fi network. If a passcode has been specified for the multifunction display's Wi-Fi connection ensure that the same passcode is entered into the iPhone when prompted.
No Raymarine app on device.	Tablet / smartphone does not have Raymarine app installed and running.	Download the required Raymarine app from the relevant application store. Start the Raymarine app on your device.
	Mobile applications are NOT enabled on the multifunction display.	Enable "Viewing only" or "Remote Control" (Homescreen: > Set-Up > System Settings > Wireless Connections > Mobile Apps).
Raymarine app runs slowly or not at all.	Device not compatible with Raymarine app.	Recommended device requirements: <ul style="list-style-type: none"> • iOS Devices = Best performance achieved on iPhone 4 or later and iPad 2 or later. • Android/Kindle Fire = Best performance achieved with 1GHz processor and better and running 2.2.2. or later.
	MFD software incompatible with mobile application.	Ensure your MFD contains software application version 3.15 or later.
No waypoint / routes synchronization with Navionics Marine app.	Smartphone / tablet does not have "Navionics Marine" app installed and running.	Download the "Navionics Marine" app from the relevant app store. Start the "Navionics Marine" app on the device.
	Chart application is not running on the multifunction display.	Start the chart application on the multifunction display.
Weak or intermittent Wi-Fi signal.	Interference from other wireless devices in the vicinity.	Multiple wireless devices running simultaneously (such as laptops, phones, and other wireless devices) can sometimes cause wireless signal conflicts. Temporarily disable each wireless device in turn until you have identified the device causing the interference.
Smartphone / tablet can no longer connect to the internet or receive e-mails after using a Raymarine mobile app.	Device still connected to the multifunction display.	Ensure the access point on your device is switched back to your previous access point (e.g. the marina Wi-Fi).

30.12 Bluetooth troubleshooting

Aspects of the installation can cause problems with the data shared between wireless devices. Such problems, their possible causes and solutions are described here.

Problem	Possible causes	Possible solutions
No wireless connection.	iPhone does not have a Bluetooth connection established with the multifunction display.	Ensure that Bluetooth is enabled on the multifunction display (Homescreen: > Set-Up > System Settings > Connections > Bluetooth > On).
		Ensure that the “Bluetooth” option is enabled on the iPhone (available from the phone's Settings / General menu).
		Ensure that the Bluetooth device is paired with the multifunction display that you want to use it with. To do this: Homescreen: > Set-Up > System Settings > Connections > New Bluetooth Connection .
No media player control.	Media player device is not compatible with the Bluetooth 2.1+ EDR power class 1.5 (supported profile: AVRCP 1.0) or higher.	Check the Bluetooth compatibility with the device manufacturer. If the device is not Bluetooth 2.1+ EDR power class 1.5 (supported profile: AVRCP 1.0) compatible then it is not suitable for wireless use with the multifunction display.
	“Audio Control” is NOT enabled on the multifunction display.	Enable “Audio Control” (Homescreen: > Set-Up > System Settings > Connections > Connections Manager > Audio Control > On).
Weak or intermittent Bluetooth signal.	Interference from other wireless devices in the vicinity.	Multiple wireless devices running simultaneously (such as laptops, phones, and other wireless devices) can sometimes cause wireless signal conflicts. Temporarily disable each wireless device in turn until you have identified the device causing the interference.

30.13 Touchscreen troubleshooting

Problems with the touchscreen and their possible causes and solutions are described here.

Problem	Possible causes	Possible solutions
Touchscreen does not operate as expected.	Touch lock is enabled.	Use the Joystick to turn off the touch lock on the home screen.
	Screen is not being operated with bare fingers, for example gloves are being worn.	Bare fingers must make contact with the screen for correct operation. Alternatively you may use conductive gloves.
	Touchscreen requires calibration.	Use the setup menus to calibrate the touchscreen.
	Saltwater deposits on the screen.	Carefully clean and dry the screen in accordance with the instructions provided.

30.14 Miscellaneous troubleshooting

Miscellaneous problems and their possible causes and solutions are described here.

Problem	Possible causes	Possible solutions
Display behaves erratically: <ul style="list-style-type: none"> • Frequent unexpected resets. • System crashes or other erratic behavior. 	Intermittent problem with power to the display.	Check relevant fuses and breakers. Check that the power supply cable is sound and that all connections are tight and free from corrosion. Check that the power source is of the correct voltage and sufficient current.
	Software mismatch on system (upgrade required).	Go to www.raymarine.com and click on support for the latest software downloads.
	Corrupt data / other unknown issue.	Perform a factory reset. <div style="border: 1px solid black; padding: 5px; margin-top: 5px;"> <p>Important: This will result in the loss of any settings and data (such as waypoints) stored on the product. Save any important data to a memory card before resetting.</p> </div>

Chapter 31: Technical specification

Chapter contents

- [31.1 Technical specification on page 412](#)

31.1 Technical specification

Physical specifications

	gS95	gS125
Dimensions	<ul style="list-style-type: none"> Width: 246.8 mm (9.7 in.) Height: 188.2 mm (7.4 in.) Depth (NOT including cables): 77 mm (3 in.) Depth (including cables): 198 mm (7.8 in.) 	<ul style="list-style-type: none"> Width: 311.8 mm (12.3 in.) Height: 237.1 mm (9.3 in.) Depth (NOT including cables): 78 mm (3 in.) Depth (including cables): 198 mm (7.8 in.)
Weight (bare unit)	3 Kg (6.63 lbs)	3.9 Kg (8.6 lbs)

	gS165	gS195
Dimensions	<ul style="list-style-type: none"> Width: 383.2 mm (15 in.) Height: 284.7 mm (11.2 in.) Depth (NOT including cables): 77 mm (3 in.) Depth (including cables): 198 mm (7.8 in.) 	<ul style="list-style-type: none"> Width: 433.9 mm (17 in.) Height: 391.2 mm (15.4 in.) Depth (NOT including cables): 83.9 mm (3.3 in.) Depth (including cables): 198 mm (7.8 in.)
Weight (bare unit)	5.2 Kg (11.5 lbs)	9.6 Kg (21.2 lbs)

Power specification

Nominal supply voltage	12 V dc to 24 V dc
Operating voltage range	10.8 V dc to 31.2 V dc
Fuse / Breakers	In-line fuse (fitted within power cable) <ul style="list-style-type: none"> 15 A. (Standard 20 mm glass fuse)
Power consumption (without PoE)	gS95 <ul style="list-style-type: none"> Full brightness: 19.5 W Max PowerSave mode: 12.8 W Max Standby: 5 W Max
	gS125 <ul style="list-style-type: none"> Full brightness: 29.6 W Max PowerSave mode: 12.4 W Max Standby: 5 W Max

	gS165 <ul style="list-style-type: none"> Full brightness: 56.2 W Max PowerSave mode: 15.1 W Max Standby: 5 W Max
	gS195 <ul style="list-style-type: none"> Full brightness: 64.8 W Max PowerSave mode: 15.8 W Max Standby: 5 W Max
Power consumption (with PoE)	gS95 <ul style="list-style-type: none"> Full brightness: 44.9 W Max PowerSave mode: 37.9 W Max Standby: 40 W Max
	gS125 <ul style="list-style-type: none"> Full brightness: 57.1 W Max PowerSave mode: 40.1 W Max Standby: 40 W Max
	gS165 <ul style="list-style-type: none"> Full brightness: 85.7 W Max PowerSave mode: 43 W Max Standby: 40 W Max
	gS195 <ul style="list-style-type: none"> Full brightness: 100.7 W Max PowerSave mode: 44.5 W Max Standby: 40 W Max
LEN (Refer to Seata ^{ng} reference manual for further information).	1

Note: Figures with PoE represent a full load of 20 W PoE)

Environmental specification

Environmental specifications below apply to all display variants

Operating temperature	-25 °C to +55 °C (-13 °F to 131 °F)
Storage temperature	-30 °C to +70 °C (-22 °F to 158 °F)

Relative humidity	Maximum 75%
Waterproof rating	IPX6

Display specification

	gS95	gS125
Size	9 in.	12.1 in.
Type	TFT backlit LED	TFT backlit LED
Color depth	24-bit	24-bit
Resolution	800 x 480 pixels (WVGA)	1280 x 800 pixels (WVGA)
Aspect Ratio	16:9	16:9
Maximum allowable wrongly illuminated pixels	8	8

	gS165	gS195
Size	15.4 in.	19 in.
Type	TFT backlit LED	TFT backlit LED
Color depth	24-bit	24-bit
Resolution	1280 x 800 pixels (WVGA)	1280 x 1024 pixels (SXGA)
Aspect Ratio	16:9	4:3
Maximum allowable wrongly illuminated pixels	8	5

Data connections

Wired connections

NMEA 0183	2x NMEA 0183 ports: <ul style="list-style-type: none"> NMEA port 1: Input and output, 4800 / 38400 baud NMEA port 2: Input only, 4800 / 38400 baud
Network (SeaTalk ^{hs})	<ul style="list-style-type: none"> gS95, gS125, gS165 – 3 x RayNet SeaTalk^{hs} ports. 10 / 100 / 1000 Mbits/s with PoE gS195– 2x RayNet SeaTalk^{hs} ports. 10 / 100 / 1000 Mbits/s with PoE
SeaTalk ^{ng}	1 x SeaTalk ^{ng} connection
Remote Card Reader	1 x Remote Card Reader connection
Alarm	1 x Alarm output

Wireless connections

Wi-Fi	802.11 b / g
Bluetooth	AVRCP 2.1+ EDR power class 1.5

Video specification

Format	PAL or NTSC
Connector type	<ul style="list-style-type: none"> 1 x HDMI output *1 x BNC connector (HD-SDI input gS195 only) 2 x composite video inputs
Output resolution	720p (fixed)

Internal storage

Multifunction displays (MFDs) include internal storage that can be used to store recorded video and photos taken using the Camera application. The table below shows the approximate available internal storage space for **LightHouse** powered MFDs.

MFD variant	Approximate available internal storage	Approximate record time (CAM200IP)
a Series	2 GB	88.8 minutes
c Series	2 GB	88.8 minutes
e Series (excluding e165)	2 GB	88.8 minutes
e165	6 GB	266.6 minutes
gS Series	14 GB	622.2 minutes

Note:

- The available internal storage stated above is based on MFD manufactured after May 2014. Available storage on displays manufactured prior to this date may vary.
- Available internal storage space is subject to change without prior notice.
- The approximate record times stated above were taken using a **CAM200IP** set to its default resolution of 720p. Increasing image resolution and other factors such as lighting conditions may affect the resulting filesize and therefore reduce the available record time.

HD-SDI interface specification

The HD-SDI interface specification for the gS195 is below.

Format	PAL or NTSC
Connector type	BNC connectors (75 ohm nominal impedance)
Input resolution	<ul style="list-style-type: none"> 720p (up to 60 fps) 1080p (up to 30 fps)
Camera audio	No

Electronic chart specification

Embedded electronic charts	<ul style="list-style-type: none">• LightHouse Charts world base map.• Navionics world base map.
Compatible LightHouse charts	<ul style="list-style-type: none">• Vector — LightHouse charts• Raster — LightHouse charts
Compatible Navionics chart cards	<ul style="list-style-type: none">• Navionics Ready to Navigate• Navionics Silver• Navionics Gold• Navionics Gold+• Navionics Platinum• Navionics Platinum+• Navionics Fish'N Chip• Navionics Hotmaps

Note:

Refer to the Raymarine website (www.raymarine.com) for the latest list of supported charts.

Conformance specification

Conformance certification applies to all display variants

Conformance	<ul style="list-style-type: none">• NMEA 2000 certification• WiFi Alliance certification• Bluetooth certification• Europe: 1999/5/EC• Australia and New Zealand: C-Tick, Compliance Level 2• FCC 47CFR part 15• Industry Canada RSS210
--------------------	--

Chapter 32: Technical support

Chapter contents

- [32.1 Raymarine customer support on page 416](#)
- [32.2 Learning resources on page 416](#)
- [32.3 Third-party support on page 417](#)

32.1 Raymarine customer support

Raymarine provides a comprehensive customer support service. You can contact customer support through the Raymarine website, telephone and e-mail. If you are unable to resolve a problem, please use any of these facilities to obtain additional help.

Web support

Please visit the customer support area of our website at:

www.raymarine.com

This contains Frequently Asked Questions, servicing information, e-mail access to the Raymarine Technical Support Department and details of worldwide Raymarine agents.

Telephone and e-mail support

In the USA:

- **Tel:** +1 603 324 7900
- **Toll Free:** +1 800 539 5539
- **E-mail:** support@raymarine.com

In the UK, Europe, and the Middle East:

- **Tel:** +44 (0)13 2924 6777
- **E-mail:** ukproduct.support@raymarine.com

In Southeast Asia and Australia:

- **Tel:** +61 (0)29479 4800
- **E-mail:** aus.support@raymarine.com

Product information

If you need to request service, please have the following information to hand:

- Product name.
- Product identity.
- Serial number.
- Software application version.
- System diagrams.

You can obtain this product information using the menus within your product.

Viewing product information

With the homescreen displayed:

1. Select **Set-up**.
2. Select **Maintenance**.
3. Select **Diagnostics**.
4. Select **Select Device**.
5. Select the relevant product from the list.
6. Select **Show All Data**.

32.2 Learning resources

Raymarine has produced a range of learning resources to help you get the most out of your products.

Video tutorials

	Raymarine official channel on YouTube: <ul style="list-style-type: none">• http://www.youtube.com/user/RaymarineInc
	Video Gallery: <ul style="list-style-type: none">• http://www.raymarine.co.uk/view/?id=2679
	Product Support videos: <ul style="list-style-type: none">• http://www.raymarine.co.uk/view/?id=4952

Note:

- Viewing the videos requires a device with an Internet connection.
- Some videos are only available in English.

Training courses

Raymarine regularly runs a range of in-depth training courses to help you make the most of your products. Visit the Training section of the Raymarine website for more information:

- <http://www.raymarine.co.uk/view/?id=2372>

FAQs and Knowledge Base

Raymarine has produced an extensive set of FAQs and a Knowledge Base to help you find more information and troubleshoot any issues.

- <http://www.raymarine.co.uk/knowledgebase/>

Technical support forum

You can use the Technical support forum to ask a technical question about a Raymarine product or to find out how other customers are using their Raymarine equipment. The resource is regularly updated with contributions from Raymarine customers and staff:

- <http://raymarine.ning.com/>

32.3 Third-party support

Contact and support details for third-party suppliers can be found on the appropriate websites.

Fusion

www.fusionelectronics.com

Navionics

www.navionics.com

Sirius

www.sirius.com

Chapter 33: Spares and accessories

Chapter contents

- 33.1 gS Series accessories on page 420
- 33.2 gS Series spares on page 420
- 33.3 Network hardware on page 421
- 33.4 Network cable connector types on page 421
- 33.5 **RayNet** to **RayNet** cables and connectors on page 422
- 33.6 Network cable types on page 424
- 33.7 SeaTalk^{ng} cabling components on page 424
- 33.8 SeaTalk^{ng} cables and accessories on page 425
- 33.9 SeaTalk accessories on page 426

33.1 gS Series accessories

The following accessories are available for gS Series displays.

Description	Part number
RMK-9 remote keypad	A80217
RCR-2 Remote Card Reader	A80218
5 m (16.4 ft) gS Series Video out cable (HDMI)	A80219
2 m 6.6 ft) gS Series Video In / Alarm Out cable	A80235
1.5 m (4.9 ft) Straight power and data cable	R62379
1.5 m (4.9 ft) Right angled power and data cable	R70029

33.2 gS Series spares

The following accessories are available for gS Series displays.

Description	Part number
gS95 suncover	R70180
gS125 suncover	R70181
gS165 suncover	R70182
gS195 suncover	R70290
gS195 BNC (HD-SDI) protective boot kit	R70292
Card reader door	R70183
Card reader fitting kit	R70184
gS95 Mounting kit	A80220
gS125 Mounting kit	A80263
gS165 Mounting kit	A80264
gS195 Mounting kit	R70291

33.3 Network hardware

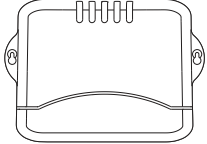
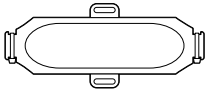
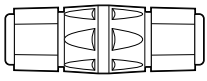
Item	Part number	Notes
HS5 RayNet network switch 	A80007	5-port switch for network connection of multiple devices featuring RayNet connectors. Equipment with RJ45 SeaTalk ^{hs} connectors can also be connected using suitable adapter cables.
RJ45 SeaTalk ^{hs} network switch 	E55058	8-port switch for network connection of multiple SeaTalk ^{hs} devices featuring RJ45 connectors.
RJ45 SeaTalk ^{hs} crossover coupler 	E55060	<ul style="list-style-type: none"> Enables direct connection of RJ45 SeaTalk^{hs} devices to smaller systems where a switch is not required. Enables the connection of RJ45 SeaTalk^{hs} devices to a HS5 RayNet network switch (in conjunction with suitable adapter cables). Enables 2 RJ45 SeaTalk^{hs} cables to be connected together to extend the length of the cabling. Recommended for internal installations. <div style="border: 1px solid black; padding: 5px; margin-top: 10px;"> Important: Do NOT use crossover devices for POE (Power Over Ethernet) connections. </div>
Ethernet RJ45 coupler 	R32142	<ul style="list-style-type: none"> Enables direct connection of RJ45 SeaTalk^{hs} devices to smaller systems where a switch is not required. Enables the connection of RJ45 SeaTalk^{hs} devices to a HS5 RayNet network switch (in conjunction with suitable adapter cables). Enables 2 RJ45 SeaTalk^{hs} cables to be connected together to extend the length of the cabling. Recommended for external installations.

33.4 Network cable connector types

There are 2 types of network cable connector — SeaTalk^{hs} and RayNet.

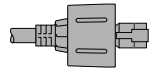
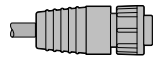
	SeaTalk^{hs} connector — used for connecting SeaTalk ^{hs} devices to a Raymarine network switch via SeaTalk ^{hs} cables.
	RayNet connector — used for connecting Raymarine network switches and SeaTalk ^{hs} devices to the multifunction display via RayNet cables. Also required for connecting a crossover coupler if only one device is being connected to the display's Network connector.

33.5 RayNet to RayNet cables and connectors

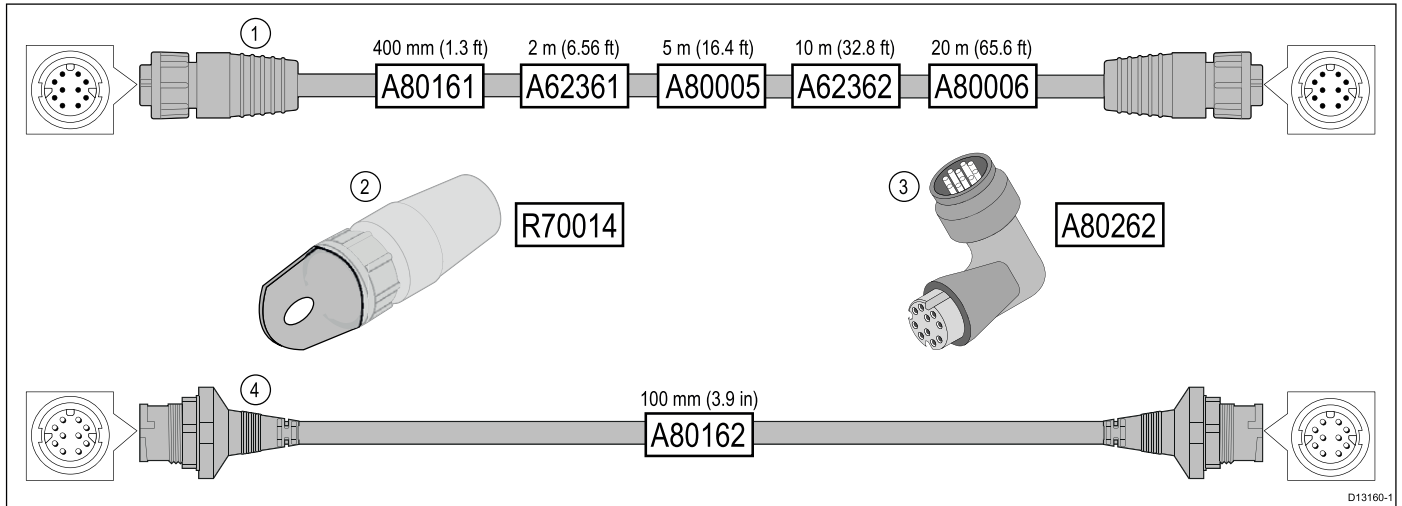

D13160-1

	Description	Typical use	Quantity
1	Standard RayNet connection cable with a RayNet (female) socket on both ends.	Suitable for connecting all RayNet equipment directly to LightHouse multifunction displays featuring a RayNet connector. Can also be used to connect RayNet equipment via a RayNet network switch (e.g. HS5).	1
2	RayNet cable puller (5 pack).	These “handles” securely attach to the twist-lock on RayNet cables, enabling you to pull the cables through conduits and other obstacles.	5
3	RayNet to RayNet right-angle coupler / adapter.	Suitable for connecting RayNet cables at 90° (right angle) to devices, for installations where space is limited. For example, use this adapter to connect a RayNet cable to a multifunction display when there is not enough space behind the display for the usual cable bend radius required by a standard RayNet cable. This adapter features a RayNet (female) socket at one end, and a RayNet (male) plug at the other end.	1
4	Adapter cable with a RayNet (male) plug on both ends.	Suitable for joining (female) RayNet cables together for longer cable runs.	1

RayNet to RJ45 adapter cables

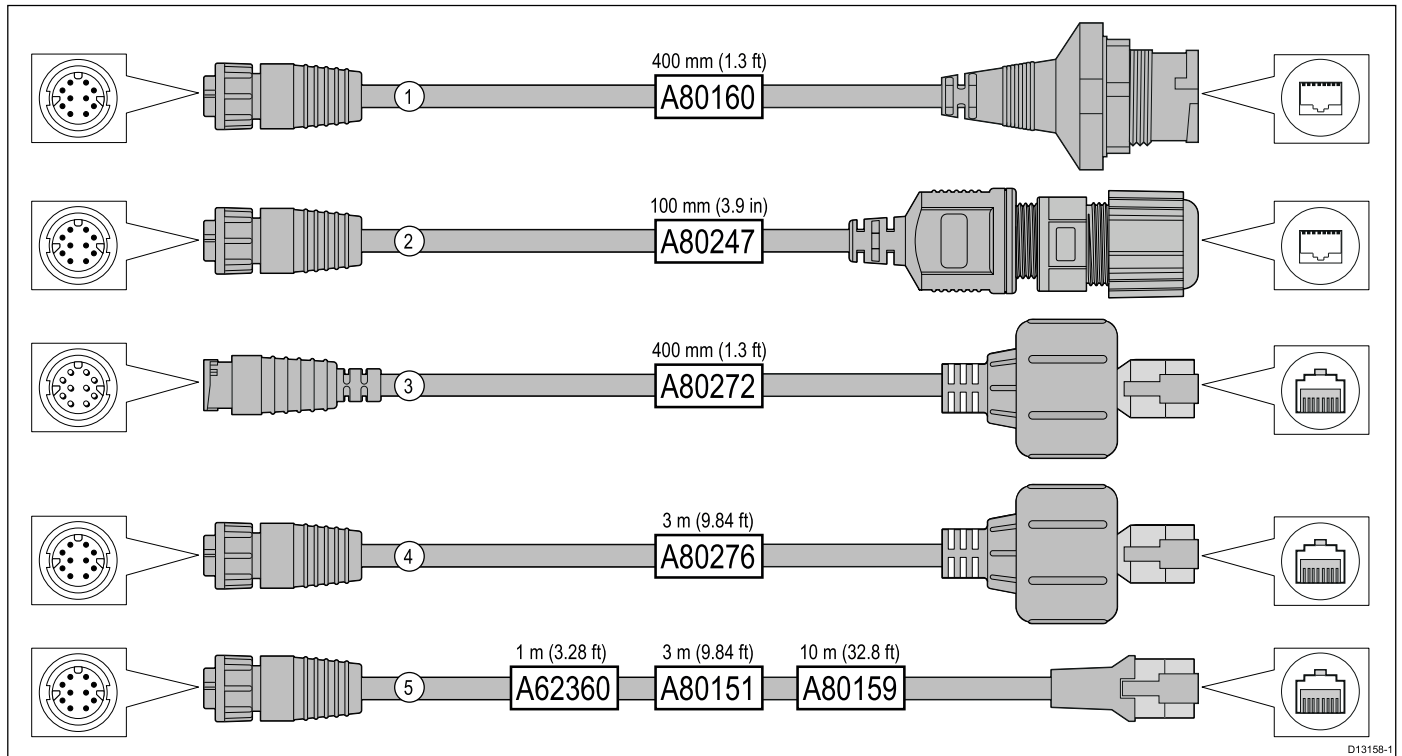

D13158-1

	Description	Typical use	Quantity
1	<p>Adapter cable with a RayNet (female) socket on one end, and a waterproof (female) socket on the other end accepting the following cables with an RJ45 SeaTalk^{hs} waterproof locking (male) plug:</p> <ul style="list-style-type: none"> • A62245 (1.5 m). • A62246 (15 m). 	<p>A typical use for this adapter cable is to connect a DSM300 sonar module to a LightHouse MFD, using all-waterproof cable connections. This adapter cable will also accept the following RJ45 SeaTalk^{hs} cables, although the RJ45 plug that connects at the equipment end (e.g. DSM300) will NOT be waterproof:</p> <ul style="list-style-type: none"> • E55049 (1.5 m). • E55050 (5 m). • E55051 (10 m). • A62135 (15 m). • E55052 (20 m). 	1
2	<p>Adapter cable with a RayNet (female) socket on one end, and a waterproof (female) RJ45 socket on the other end, along with a locking gland for a watertight fit.</p>	<p>Directly connect a Raymarine radar scanner with an RJ45 SeaTalk^{hs} (male) cable to a RayNet network switch (e.g. HS5) or LightHouse MFD.</p>	1
3	<p>Adapter cable with a RayNet (male) plug on one end, and an RJ45 SeaTalk^{hs} waterproof (male) plug on the other end.</p>	<p>Connect a legacy G-Series GPM-400, C-Series Widescreen or E-Series Widescreen MFD to a Raymarine radar scanner supplied with a RayNet power / data cable.</p>	1
4	<p>Adapter cable with a RayNet (female) socket on one end, and an RJ45 SeaTalk^{hs} waterproof (male) plug on the other end.</p>	<p>Connect a legacy G-Series GPM-400, C-Series Widescreen or E-Series Widescreen MFD to a RayNet network switch (e.g. the HS5).</p>	1
5	<p>Adapter cable with a RayNet (female) socket on one end, and an RJ45 SeaTalk^{hs} (female) socket on the other end.</p>	<p>Connect a LightHouse MFD to a legacy SR6 switch / weather receiver or a legacy 8–port SeaTalk^{hs} network switch. Another common use for the cable is in conjunction with a crossover coupler (E55060 or R32142) to connect Raymarine products with an RJ45 connection (e.g. radar scanner, thermal camera or DSM300) to a LightHouse MFD or RayNet network switch (e.g. the HS5).</p>	1

33.6 Network cable types

There are 2 types of SeaTalk^{hs} network cable — “patch” and “network”.

- **Patch** — for connecting the following devices to a Raymarine network switch:
 - Thermal camera via PoE injector.
 - Additional Raymarine network switch.
 - PC or laptop using Voyager planning software.
- **Network** — for connecting the following devices to a Raymarine network switch:
 - Sonar Module.
 - SR100 Sirius weather receiver.
 - Additional compatible Raymarine multifunction displays.

SeaTalk^{hs} network cables

Cable	Part number
1.5 m (4.9 ft) SeaTalk ^{hs} network cable	E55049
5 m (16.4 ft) SeaTalk ^{hs} network cable	E55050
10 m (32.8 ft) SeaTalk ^{hs} network cable	E55051
20 m (65.6 ft) SeaTalk ^{hs} network cable	E55052

SeaTalk^{hs} patch cables

Cable	Part number
1.5 m (4.9 ft) SeaTalk ^{hs} patch cable	E06054
5 m (16.4 ft) SeaTalk ^{hs} patch cable	E06055
10 m (32.8 ft) SeaTalk ^{hs} patch cable	E06056
15 m (49.2 ft) SeaTalk ^{hs} patch cable	A62136
20 m (65.6 ft) SeaTalk ^{hs} patch cable	E06057

33.7 SeaTalk^{ng} cabling components

SeaTalk^{ng} cabling components and their purposes.

Connection / Cable	Notes
Backbone cable (various lengths)	The main cable carrying data. Spurs from the backbone are used to connect SeaTalk ^{ng} devices.
T-piece connector	Used to make junctions in the backbone to which devices can then be connected.
Terminator	Required at either end of the backbone.
Inline terminator	Used to connect a spur cable directly to the end of a backbone; useful for longer cable runs.
Spur cable	Used to connect devices to the backbone. Devices may be daisy chained or connected directly to the T-pieces.
SeaTalk ^{ng} 5-way connector	Used to branch, split, or make additional connections in SeaTalk or SeaTalk ^{ng} networks.
Blanking plug	Inserted into unused spur connector positions in a 5-way connector or T-piece.

33.8 SeaTalk^{ng} cables and accessories

SeaTalk^{ng} cables and accessories for use with compatible products.

Description	Part No	Notes
SeaTalk ^{ng} starter kit	T70134	Includes: <ul style="list-style-type: none"> • 1 x 5 Way connector (A06064) • 2 x Backbone terminator (A06031) • 1 x 3 m (9.8 ft) spur cable (A06040) • 1 x Power cable (A06049)
SeaTalk ^{ng} Backbone Kit	A25062	Includes: <ul style="list-style-type: none"> • 2 x 5 m (16.4 ft) Backbone cable (A06036) • 1 x 20 m (65.6 ft) Backbone cable (A06037) • 4 x T-piece (A06028) • 2 x Backbone terminator (A06031) • 1 x Power cable (A06049)
SeaTalk ^{ng} 0.4 m (1.3 ft) spur	A06038	
SeaTalk ^{ng} 1 m (3.3 ft) spur	A06039	
SeaTalk ^{ng} 3 m (9.8 ft) spur	A06040	
SeaTalk ^{ng} 5 m (16.4 ft) spur	A06041	
SeaTalk ^{ng} 0.4 m (1.3 ft) elbow spur	A06042	
SeaTalk ^{ng} 0.4 m (1.3 ft) backbone	A06033	
SeaTalk ^{ng} 1 m (3.3 ft) backbone	A06034	
SeaTalk ^{ng} 3 m (9.8 ft) backbone	A06035	
SeaTalk ^{ng} 5 m (16.4 ft) backbone	A06036	
SeaTalk ^{ng} 9 m (29.5 ft) backbone	A06068	
SeaTalk ^{ng} 20 m (65.6 ft) backbone	A06037	
SeaTalk ^{ng} to bare ends 1 m (3.3 ft) spur	A06043	
SeaTalk ^{ng} to bare ends 3 m (9.8 ft) spur	A06044	

Description	Part No	Notes
SeaTalk ^{ng} Power cable	A06049	
SeaTalk ^{ng} Terminator	A06031	
SeaTalk ^{ng} T-piece	A06028	Provides 1 x spur connection
SeaTalk ^{ng} 5-way connector	A06064	Provides 3 x spur connections
SeaTalk ^{ng} backbone extender	A06030	
SeaTalk to SeaTalk ^{ng} converter kit	E22158	Allows the connection of SeaTalk devices to a SeaTalk ^{ng} system.
SeaTalk ^{ng} Inline terminator	A80001	Provides direct connection of a spur cable to the end of a backbone cable. No T-piece required.
SeaTalk ^{ng} Blanking plug	A06032	
ACU / SPX SeaTalk ^{ng} spur cable 0.3 m (1.0 ft)	R12112	Connects an SPX course computer or an ACU to a SeaTalk ^{ng} backbone.
SeaTalk (3 pin) to SeaTalk ^{ng} adaptor cable 0.4 m (1.3 ft)	A06047	
SeaTalk to SeaTalk ^{ng} spur 1 m (3.3 ft) spur	A22164	
SeaTalk2 (5 pin) to SeaTalk ^{ng} adaptor cable 0.4 m (1.3 ft)	A06048	
DeviceNet adaptor cable (Female)	A06045	Allows the connection of NMEA 2000 devices to a SeaTalk ^{ng} system.
DeviceNet adaptor cable (Male)	A06046	Allows the connection of NMEA 2000 devices to a SeaTalk ^{ng} system.
DeviceNet adaptor cable (Female) to bare ends.	E05026	Allows the connection of NMEA 2000 devices to a SeaTalk ^{ng} system.
DeviceNet adaptor cable (Male) to bare ends.	E05027	Allows the connection of NMEA 2000 devices to a SeaTalk ^{ng} system.

33.9 SeaTalk accessories

SeaTalk cables and accessories for use with compatible products.

Description	Part No	Notes
3-way SeaTalk junction box	D244	
1 m (3.28 ft) SeaTalk extension cable	D284	
3 m (9.8 ft) SeaTalk extension cable	D285	
5 m (16.4 ft) SeaTalk extension cable	D286	
9 m (29.5 ft) SeaTalk extension cable	D287	
12 m (39.4 ft) SeaTalk extension cable	E25051	
20 m (65.6 ft) SeaTalk extension cable	D288	

Appendix A Connectors and pinouts

Power, data, and video connector

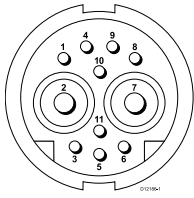

Item	Remarks
Identification	PWR / NMEA / Video
Connector type	11 pin twist-lock
Current source to network	No current sourced for external devices
Current sink from network	<ul style="list-style-type: none"> PSU: Main Power input. NMEA: No power required for interface. Video: No power required for interface.

Power, data and video cable cores and colors

Signal	Pin	AWG	Color
BATT+	2	16	Red
BATT-	7	16	Black
SCREEN	10	26	Black
NMEA1 TX+	8	26	Yellow
NMEA1 TX-	9	26	Brown
NMEA1 RX+	1	26	White
NMEA1 RX-	4	26	Green
NMEA2 RX+	3	26	Orange / White
NMEA2 RX-	11	26	Orange / Green
VIDEO IN	6	RG179 coaxial	
VIDEO RTN	5	Screen	

PoE Network connector

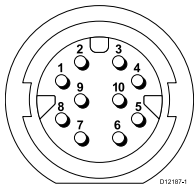

Pin	Cable	Signal	PoE
1	White / Orange	BI_DA+	DC+
2	Orange	BI_DA-	DC+
3	Blue	BI_DC+	DC+
4	White / Blue	BI_DC-	DC+
5	White / Green	BI_BD+	DC-
6	Green	BI_BD-	DC-

Pin	Cable	Signal	PoE
7	White / Brown	BI_DD+	DC-
8	Brown	BI_DD-	DC-
9	Not connected	Not connected	Not connected
10	Foil	Shield	Isolated from 0V

Note: Use only Raymarine **RayNet** cables when connecting **SeaTalk^{hs}** devices.

SeaTalk^{ng} connector

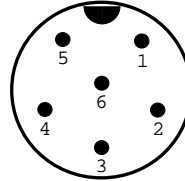

Item	Remarks
Identification	ST2/NMEA2000
Connector type	STNG
Current source to network	No current sourced for external devices
Current sink from network	<160mA (Interface drive only)

Pin	Signal
1	+12V
2	0V
3	Screen
4	CanH
5	CanL
6	SeaTalk (not connected)

Note: Use only Raymarine cables when connecting to SeaTalk^{ng}

Video in / Alarm out connector

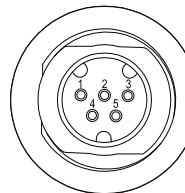

Pin 1	Alarm +
Pin 2	Alarm -
Pin 3	Purple
Pin 4	Video Screen
Pin 5	Video Core

Appendix B NMEA 0183 sentences

The display supports the following NMEA 0183 sentences. These are applicable to NMEA 0183 and SeaTalk protocols.

Sentence	Description	Transmit	Receive
AAM	Waypoint arrival alarm sentence		•
APB	Autopilot sentence 'B'	•	•
BWC	Bearing and distance to waypoint	•	•
BWR	Bearing and distance to waypoint — Rhumb	•	•
DBT	Depth below transducer	•	•
DPT	Depth	•	•
DSC	Digital selective calling information sentence		•
DSE	Distress sentence expansion		•
DTM	Datum reference sentence		•
GBS	GPS satellite fault detection data sentence		•
GGA	GPS System fix data	•	•
GLC	Geographic position loran C sentence		•
GLL	Geographic position latitude longitude	•	•
GSA	GPS DOP and active satellites	•	•
GSV	GPS satellites in view	•	•
HDG	Heading deviation and variation sentence		•
HDT	Heading true sentence		•
HDM	Heading magnetic sentence		•
MDA	Meteorological composite sentence		•
MSK	MSK receiver interface sentence		•
MSS	MSK receiver signal status sentence		•
MTW	Water temperature	•	•
MWV	Wind speed and angle	•	•
RMB	Recommended minimum navigation information	•	•
RMC	Recommended minimum specific GNSS data	•	•
RSD	Radar system data	•	•
TTM	Tracked target message	•	•
VHW	Water speed and heading	•	•
VLW	Distance travelled through the water	•	•
VTG	Course over ground and ground speed	•	•
XTE	Cross track error measured sentence		•
ZDA	Time and date	•	•

NMEA data bridging

NMEA data bridging allows data that exists on the display's NMEA 2000 bus to be repeated to NMEA 0183 devices, and vice versa.

An example of NMEA data bridging is in a system that includes a third-party GPS receiver connected to the NMEA 0183 Input of a Raymarine display. The GPS data messages transmitted by the GPS receiver are repeated to any appropriate devices connected to the display's NMEA 2000 bus. Bridging

only occurs when the data is being transmitted by an NMEA 0183 device that is not already being transmitted by a NMEA 2000 device, and vice versa.

For a list of data messages (PGN sentences) that are bridged between NMEA 2000 and NMEA 0183, refer to the list of supported NMEA 2000 sentences provided in this document.

Appendix C NMEA 2000 sentences

The display supports the following NMEA 2000 sentences. These are applicable to NMEA 2000, SeaTalk^{ng} and SeaTalk 2 protocols.

Message number	Message description	Transmit	Receive	Bridged to NMEA 0183
59392	ISO Acknowledgment	•	•	
59904	ISO Request	•	•	
60928	ISO Address Claim	•	•	
126208	NMEA - Request group function	•	•	
126464	PGN List – Receive / Transmit PGN's Group function	•	•	
126992	System time	•	•	
126996	Product information	•	•	
126998	Configuration information		•	
127237	Heading / Track Control		•	
127245	Rudder		•	
127250	Vessel heading	•	•	•
127251	Rate of Turn	•	•	
127257	Attitude	•	•	
127258	Magnetic Variation	•		
127488	Engine parameters, rapid update		•	
127489	Engine parameters, dynamic		•	
127493	Transmission parameters, dynamic		•	
127496	Trip parameters, Vessel		•	
127497	Trip parameters, Engine		•	
127498	Engine parameters, static		•	
127503	AC Input status		•	
127504	AC Output status		•	
127505	Fluid level		•	
127506	DC Detailed status		•	
127507	Charger Status		•	
127508	Battery status		•	
127509	Inverter status		•	
128259	Speed (water referenced)	•	•	•
128267	Water depth	•	•	•
128275	Distance log	•	•	•
129025	Position, rapid update	•	•	•
129026	COG and SOG, rapid update	•	•	•
129029	GNSS position data	•	•	•
129033	Time and date	•	•	•
129038	AIS Class A position report		•	
129039	AIS Class B position report		•	
129040	AIS Class B extended position report		•	
129041	AIS Aids to Navigation (AToN) report		•	
129044	Datum	•	•	•

Message number	Message description	Transmit	Receive	Bridged to NMEA 0183
129283	Cross track error	•	•	•
129284	Navigation data	•	•	•
129291	Set and drift, rapid update	•	•	•
129301	Time to or from mark		•	
129539	GNSS DOPs		•	
129540	GNSS Sats in view	•	•	
129542	GNSS pseudorange noise statistics	•	•	
129545	GNSS RAIM output		•	
129550	GNSS differential correction receiver interface		•	
129551	GNSS differential correction receiver signal		•	
129793	AIS UTC and date report		•	
129794	AIS Class A static and voyage related data		•	
129798	AIS SAR aircraft position report		•	
129801	AIS Addressed safety related message		•	
129802	AIS Safety related broadcast message		•	
129808	DSC call information		•	
129809	AIS class B "CS" static data report, part A		•	
129810	AIS class B "CS" static data report, part B		•	
130306	Wind data	•	•	•
130310	Environmental parameters	•	•	•
130311	Environmental parameters		•	•
130312	Temperature		•	
130313	Humidity		•	
130314	Actual pressure		•	
130576	Small craft status		•	
130577	Direction data	•	•	•
130578	Vessel speed components		•	

PGN 127489 - Support engine alarms

The following engine alarms are supported.

Engine Error
Check Engine
Over Temperature
Low Oil Pressure
Low Oil Level
Low Fuel Pressure
Low System Voltage
Low Coolant Level
Water Flow
Water in Fuel
Charge Indicator
High Boost Pressure
Rev Limit Exceeded

EGR System
Throttle Position Sensor
Engine Emergency Stop Mode
Warning Level 1
Warning Level 2
Power Reduction
Maintenance Needed
Engine Comm Error
Sub or Secondary Throttle
Neutral Start Protect
Engine Shutting Down
unknown error

Appendix D Switch panel application

Vessel control and monitoring systems

When integrated with a vessel control and monitoring system your multifunction display can provide monitoring and controls for your power circuits, breakers, switches and equipment.

The Switch Panel application can be used to:

- Show the status of power circuits, breakers, switches and other equipment.
- Apply power to each circuit individually.
- Reset tripped breakers.
- Control power to individual equipment.
- Alert users to a tripped circuit.

Vessel control and monitoring system connection

The multifunction display can connect to and control an EmpirBus NXT vessel control and monitoring system.

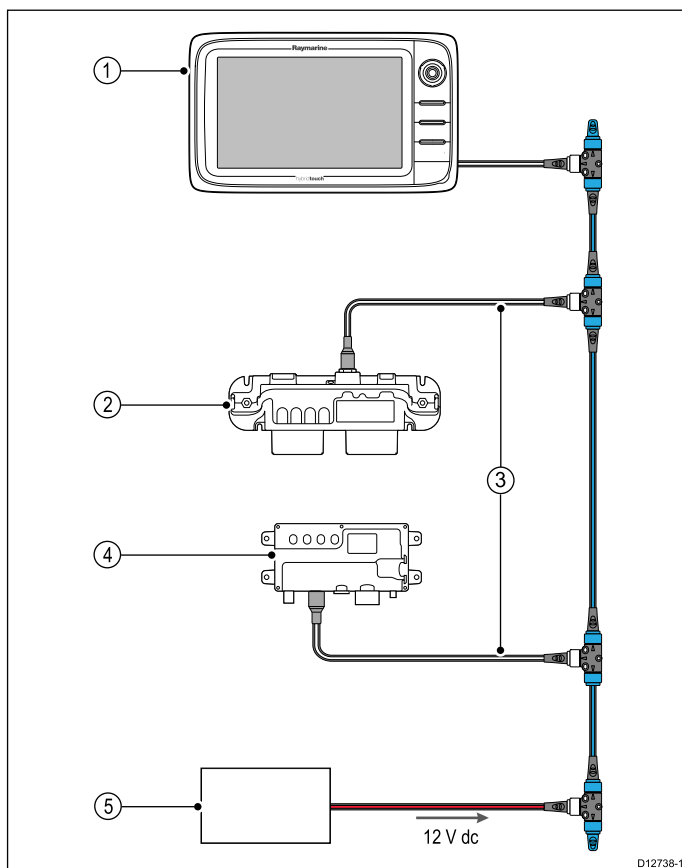

1	Raymarine multifunction display.
2	EmpirBus NXT DCM (dc module).
3	SeaTalk ^{ng} to DeviceNet adaptor cable.
4	EmpirBus NXT MCU (Master control unit).
5	12 V dc supply into backbone.

Note: Ensure your vessel control and monitoring system has been installed in accordance with the instructions provided with the system.

Switch panel configuration

The switch panel application must be configured.

A Configuration file can be obtained from the system supplier.

Loading a configuration file

The switch panel application will only be available when a valid configuration file has been loaded.

1. Obtain the configuration file from the system supplier.
2. Save the configuration file to the root directory of your memory card.
3. Insert the memory card into the card reader on your multifunction display.
4. From the homescreen select **Set-up**.
5. Select **System Settings**.
6. Select **External Devices**.
7. Select **Switch Panel Set-up**.
8. Select **Install Config File**.
9. If prompted select the memory card slot that contains your configuration file.
The file browser is opened.
10. Select the configuration file.
11. Select **OK**.

You can now add the Switch panel application from the Customize menu on the homescreen.

Note: If your multifunction display only has 1 card slot then step 9 is skipped.

Switch panel overview

The switch panel application is used to monitor and control compatible vessel control and monitoring systems. The pages and page layouts and vessel schematics are configured at installation and are unique for each vessel. The images below are examples.

Example 1 — Switch panel mode page



If configured a Mode page provides controls to switch between pre-configured modes.

In the example above selecting a mode icon will place the system into the selected mode.

You can cycle through available pages to monitor or control switches and configured groups of switches.

Example 2 — Vessel controls page

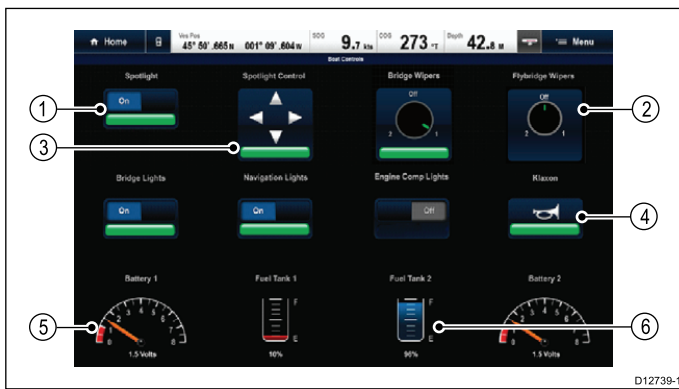

D12739-1

1	Toggle switch.
2	Rotary (multi-state) switch.
3	Position control switch.
4	Momentary switch.
5	Data item (dial gauge).
6	Data item (tank level).

Using the switches on a Touchscreen

 This only applies to HybridTouch displays.

From the switch panel application:

1. **Toggle switch** — Select the switch to switch on or off.
2. **Rotary control** — Selecting the rotary control will cycle through its available states.
3. **Position Control** — Select and hold on a direction to move.
4. **Momentary switch** — Select the switch to activate.
5. **Dimmer switch** — Select and then drag the control to adjust the value.

Using the switches

From the switch panel application:

1. Use the **Joystick** to highlight the relevant switch.
2. **Toggle switch** — Press **Ok** to switch on or off.
3. **Rotary control** — Pressing **Ok** will cycle through its available states.
4. **Position Control** — Press **Ok** and use the **Joystick** to move direction.
5. **Momentary switch** — Press **Ok** to activate.
6. **Dimmer switch** — Press **Ok** on the switch and use the **Rotary Control** to adjust the value, then select **back** to exit adjust mode.

Resetting a tripped circuit

When a circuit is tripped a pop-up message will be displayed on-screen providing details of the tripped circuit and options, the circuit will also be identified as tripped in the switch panel pages.

1. With a tripped circuit pop-up message displayed select **Reset.** to reset the tripped circuit, or
2. Select the switch on a switch panel page to reset the tripped switch.

Note: Performing multiple resets risks causing damage to your system so if a trip persists check the main circuits.

Appendix E Software releases

Raymarine regularly updates its multifunction display software to introduce improvements, additional hardware support and user interface features. The table below details some of the important enhancements and which software revision they were introduced with.

Software version	Applicable product manual	Multifunction displays compatibility	Changes
LightHouse II — V12.xx	81344-6	gS95, gS125, gS165, gS195	<ul style="list-style-type: none"> Added support for up to 2 radar scanners on the same network. Added support for displaying up to 4 camera feeds using Quad View. Added support in the Radar application for extreme latitudes up to 82 degrees north. Added 'Battery Charge' data item and changed 'RPM & Speed' data item to 'RPM & SOG' in the Data application. Increased support for number of batteries to 16.
LightHouse II — V11.26	81344-5	gS95, gS125, gS165, gS195	<ul style="list-style-type: none"> Added support for the CP200 SideVision™ sonar module. New Alarm Manager with new NMEA 2000 alarm support (providing alarm history, a list of active alarms and ability to change alarm settings all from the alarm manager). Added Autorouting feature to assist when route building with compatible Navionics® cartography. Display preferences now shared with display products over SeaTalk^{ng}. Added ability to display Radar overlay using stable COG when Heading is not available. When acknowledged, the Limitations of Use screen now dismisses globally on all networked MFDs. Added support for Hebrew User Interface language. Added ability to switch off the Waypoint arrival alarm. Added Minimum Safe Depth setting under Boat Details and included in the Start-up wizard.
LightHouse II — V10.41	81344-4	gS95, gS125, gS165, gS195	<ul style="list-style-type: none"> Support for the HD-SDI Video Input & 4:3 aspect ratio on the new gS Series gS195 display product. Add Multifunction display network compatibility with v3.xx software of CP300 & CP450C sounder modules.
LightHouse II — V10.34	81344-3	gS95, gS125, gS165	<p>New Fishfinder application</p> <ul style="list-style-type: none"> Support for multiple active sonar modules on the network Ability to display multiple sonar channels simultaneously using splitscreen pages Ability to create custom sonar channel profiles New sonar module specific Fishfinder simulator

Software version	Applicable product manual	Multifunction displays compatibility	Changes
			<ul style="list-style-type: none"> • Corrected (reversed) TVG control on CP450C to match all sonar modules • Switch panel alarms can now be enabled/disabled globally across the network • Added horizontal splitscreen template for 5.7 and 7 inch MFDs • Added support for Navionics Sonar Log depth recording • Added support for Navionics Plotter Sync mobile chart updates • Updated SiriusXM NOAA Marine Zone Boundaries updates for April 1st 2014 • AIS dangerous target alarm defaults to Off in Simulator mode and cannot be enabled. • Added additional language support for Czech and Slovenian
LightHouse II — V9.45	81344-2	gS95, gS125, gS165	<ul style="list-style-type: none"> • LightHouse II Graphics refresh • Added hide databar option • Added support for LightHouse charts • Waypoint management improvements • Chart and Radar application menu improvements • Added support for multiple sonars • Added estimated time of arrival for Routes • Added NM & m to distance units • Added digital widget to Switch panel app • Added support for DSC over NMEA 2000. • Added support for Navionics Gold chip encryption. • Updated Japanese limitations of use statement
V8.52	81344-2	gS95, gS125, gS165	<ul style="list-style-type: none"> • Added support for ECI-100 (Engine Identification Wizard)
V7.43	81344-1	gS95, gS125, gS165	<ul style="list-style-type: none"> • First release for gS Series.

Appendix F Multifunction display compatibility

The table below identifies the MFD software version required to support the listed **Raymarine®** hardware.

CP450C	V3.15
Raymarine mobile applications	V3.15
1kW transducer support for sonar variant displays	V3.15
Multiple thermal camera JCU's	V5.27
Sirius weather receiver	V6.27
Fusion entertainment	V6.27
Digital Switching	V6.27
Evolution autopilots	V7.43
T200 fixed mount thermal cameras	V7.43
CP100	V7.43
CP300	V7.43
RMK-9 remote keypad	V7.43
ECI-100	V8.52
LightHouse Charts	V9.45 — LightHouse II
Multiple sonar support (1 active)	V9.45 — LightHouse II
CP100 software V10.06 support	V10.41 — LightHouse II
CP300 software V4.04 support	V10.41 — LightHouse II
CP450C software V4.04 support	V10.41 — LightHouse II
Multiple active sonar modules	V10.41 — LightHouse II
CP200 SideVision™	V11.26 — LightHouse II
CAM200IP	V12.xx — LightHouse II
Dual Radar scanner support	V12.xx — LightHouse II

Raymarine[®]
BY  **FLIR**[®]