

# 10U for Klim Krios Helmets

© 1998-2018 Sena Technologies, Inc. All rights reserved.

Sena Technologies, Inc reserves the right to make any changes and improvements to its product without providing prior notice.

Sena™ is a trademark of Sena Technologies, Inc. or its subsidiaries in the USA and other countries. SF1™, SF2™, SF4™, SRL™, Momentum™, Momentum INC™, Momentum Lite™, Momentum Pro™, Momentum INC Pro™, Cavalry™, 30K™, 20S EVO™, 20S™, 10S™, 10C™, 10U™, 10Upad™, 10R™, 3S™, SMH5™, SMH5-FM™, SMH5 MultiCom™, SMH10™, SMH10R™, SPH10™, SPH10H-FM™, Prism Tube WiFi™, Prism Tube™, Prism™, Bluetooth Audio Pack for GoPro®, RC1™, RC3™, RC4™, Handlebar Remote™, Wristband Remote™, PowerPro Mount™, Powerbank™, FreeWire™, SR10™, SR10i™, SM10™, X1™, X1 Pro™, Expand™, Bluetooth Mic & Intercom™, Tufftalk™ and Tufftalk Lite™ are trademarks of Sena Technologies, Inc. or its subsidiaries. These trademarks may not be used without the express permission of Sena.

GoPro® is a registered trademark of Woodman Labs of San Mateo, California. Sena Technologies, Inc. (“Sena”) is not affiliated with Woodman Labs. The Sena Bluetooth Pack for GoPro® is an after-market accessory specially designed and manufactured by Sena Technologies, Inc. for the GoPro® Hero3 and Hero4 allowing for Bluetooth capabilities.

The Bluetooth® word mark and logos are owned by the Bluetooth SIG, Inc. and any use of such marks by Sena is under license. iPhone, iPod touch are registered trademarks of Apple Inc. Zumo™ is a trademark of Garmin Ltd. or its subsidiaries. TomTom™ is the trademark or registered trademark owned by TomTom International B.V. Other trademarks and tradenames are those of their respective owners.

# CONTENTS

1	INTRODUCTION .....	5	8	INTERCOM.....	22
2	PACKAGE CONTENTS .....	6	8.1	Two-way Intercom .....	22
3	INSTALLING THE 10U ON YOUR HELMET .....	7	8.2	Three-way Intercom .....	23
3.1	Installing the Main Unit.....	8	8.3	Four-way Intercom.....	25
4	GETTING STARTED.....	11	9	THREE-WAY CONFERENCE PHONE CALL WITH INTERCOM PARTICIPANT .....	26
4.1	Button Operation .....	11	10	GROUP INTERCOM .....	28
4.2	Powering On and Off.....	11	11	UNIVERSAL INTERCOM.....	28
4.3	Charging.....	12	11.1	Universal Intercom Pairing.....	29
4.4	Checking the Battery Level.....	12	11.2	Two-way Universal Intercom.....	30
4.5	Volume Adjustment .....	13	11.3	Three-way Universal Intercom .....	30
4.6	Sena Softwares .....	13	11.4	Four-way Universal Intercom .....	32
5	PAIRING THE 10U WITH BLUETOOTH DEVICES .....	14	12	FM RADIO .....	34
5.1	Mobile Phone Pairing - Mobile Phone, Bluetooth Stereo Device .....	14	12.1	FM Radio On and Off .....	34
5.2	Second Mobile Phone Pairing - Second Mobile Phone, GPS, and SR10.....	15	12.2	Preset Stations.....	34
5.3	Advanced Selective Pairing - A2DP Stereo or Handsfree .....	16	12.3	Seek and Save .....	34
5.4	Intercom Pairing .....	17	12.4	Scan and Save .....	35
6	MOBILE PHONE, GPS, SR10 .....	19	12.5	Temporary Preset .....	35
6.1	Mobile Phone Call Making and Answering.....	19	12.6	Region Selection .....	36
6.2	Speed Dialing.....	20	13	FUNCTION PRIORITY .....	36
6.3	GPS Navigation .....	21			
6.4	Sena SR10, Two-Way Radio Adapter .....	21			
7	STEREO MUSIC .....	21			
7.1	Bluetooth Stereo Music .....	21			
7.2	Music Sharing .....	22			

<b>14 CONFIGURATION SETTING .....</b>	<b>37</b>
14.1 Mobile Phone Pairing .....	38
14.2 Second Mobile Phone Pairing .....	38
14.3 Phone selective pairing .....	39
14.4 Media Selective Pairing .....	39
14.5 Assigning Speed Dial .....	39
14.6 Enabling/Disabling Audio Boost .....	40
14.7 Enabling/Disabling Voice Activated Phone Answering .....	40
14.8 Enabling/Disabling Voice Activated Intercom .....	41
14.9 Enabling/Disabling HD Intercom .....	41
14.10 Enabling/Disabling Voice Prompts .....	42
14.11 Enabling/Disabling RDS AF .....	42
14.12 Enabling/Disabling FM Station Guide .....	42
14.13 Enabling/Disabling Sidetone .....	42
14.14 Enabling/Disabling Advanced Noise Control™ .....	43
14.15 Delete All Bluetooth Pairing Information .....	43
14.16 Remote Control Pairing .....	43
14.17 Universal Intercom Pairing .....	43
14.18 Factory Reset .....	44
14.19 Exit Voice Configuration Menu .....	44
<b>15 REMOTE CONTROL .....</b>	<b>45</b>
<b>16 FIRMWARE UPGRADE .....</b>	<b>47</b>
<b>17 TROUBLESHOOTING .....</b>	<b>47</b>
17.1 Intercom Failure .....	47
17.2 Intercom Reconnection .....	47
17.3 Fault Reset .....	48
17.4 Factory Reset .....	48
<b>18 QUICK OPERATION REFERENCE .....</b>	<b>48</b>

<b>CERTIFICATION AND SAFETY APPROVALS .....</b>	<b>49</b>
• FCC Compliance Statement .....	49
• FCC RF Exposure Statement .....	50
• FCC Caution .....	50
• CE Declaration of Conformity .....	50
• Industry Canada Statement .....	50
• Bluetooth License .....	51
• WEEE (Waste Electrical and Electronic Equipment) .....	51
<b>SAFETY INFORMATION .....</b>	<b>51</b>
• Product Storage and Management .....	51
• Product Use .....	52
• Battery .....	52
<b>PRODUCT WARRANTY AND DISCLAIMER .....</b>	<b>53</b>
• Limited Warranty .....	53
• Warranty Exclusions .....	55
• Warranty Service .....	57

## 1 INTRODUCTION

Thank you for choosing the 10U for Klim Krios Helmets. With the 10U, you can call handsfree on your Bluetooth mobile phone, listen to stereo music or voice instructions of GPS navigations wirelessly, and have intercom conversations in full duplex with a passenger or other motorcycle riders.

The 10U is compliant with the Bluetooth 4.1 supporting the following profiles: Headset Profile, Hands-Free Profile (HFP), Advanced Audio Distribution Profile (A2DP), and Audio Video Remote Control Profile (AVRCP). Please check with the manufacturers of other device to determine their compatibility with this headset.

Please read this User's Guide carefully before using the headset. Also check [www.klim.com](http://www.klim.com) for the latest version of the User's Guide and additional information related to Sena Bluetooth products.

The 10U features:

- Bluetooth 4.1
- Invisible beauty with custom design
- Safe and easy operations by Bluetooth Low Energy Handlebar Remote
- Bluetooth intercom up to 1.6 kilometer (1.0 miles)\*
- Four-way intercom
- Voice prompts
- Smartphone App for iPhone and Android
- Built-in FM radio tuner with a station scan and save function
- Universal Intercom™
- Music sharing
- Advanced Noise Control™
- Firmware upgradeable

.....  
\* in open terrain

Key Specifications:

- Bluetooth 4.1
- Supporting profiles: Headset Profile, Hands-Free Profile (HFP), Advanced Audio Distribution Profile (A2DP), and Audio Video Remote Control Profile (AVRCP).

## 2 PACKAGE CONTENTS

• **10U Headset**

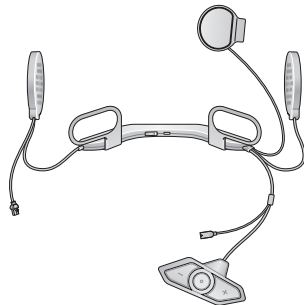

• **Wired Microphone**



• **Adhesive Tapes for the Control Unit**



• **Hook and Loop Fastener for Wired Microphone**



- **Hook and Loop Fasteners for the Main Unit**



- **Hook and Loop Fasteners for Speakers**

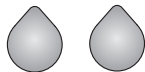

- **FM Antenna**



- **Handlebar Remote**

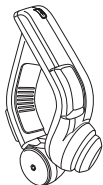

- **Handlebar Rubber Bands**

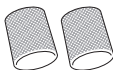

### 3 INSTALLING THE 10U ON YOUR HELMET

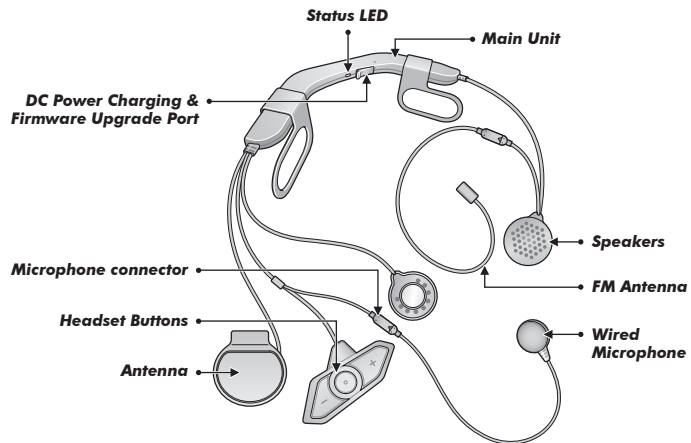

### 3.1 Installing the Main Unit

1. Before you install the 10U, remove the cheek pads and the neckroll.
2. Insert the battery unit between the external shell and the inner shell. Align its snap holders with the rear snaps, then click them through the snap holders.

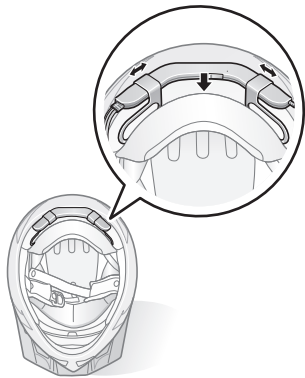

*Note:*

*You can utilize the hook and loop fasteners for main unit to tightly hold the main unit to the helmet.*

3. Slide in the antenna between the external shell and the rear left inner shell.

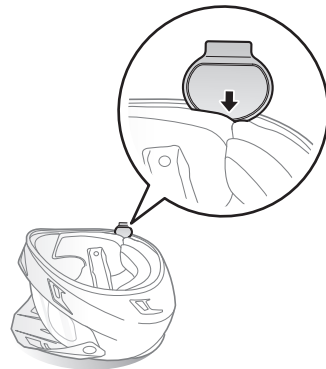



4. Peel off the cover of the adhesive tape of the control unit and attach it to the helmet.

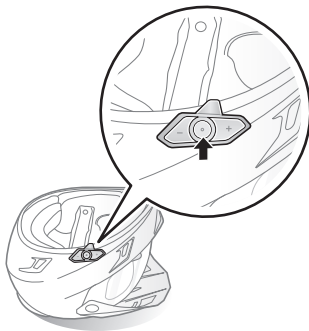

5. Peel off the cover of the adhesive tape of the hook and loop fastener for microphone and attach it on the inside of the helmet's chin guard. Attach the wired microphone on the hook and loop fastener and insert the microphone cable into the microphone connector.

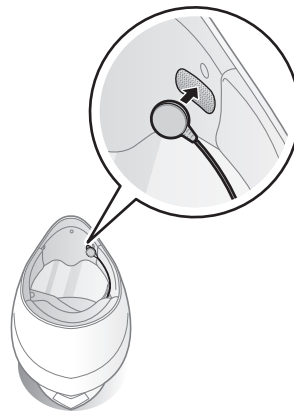

6. Peel off each cover of the hook and loop fasteners for speakers to expose the adhesive surface. Then, attach the fasteners inside the helmet where your ears will be located at.

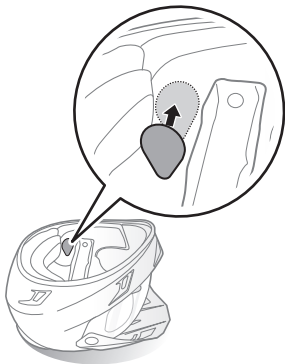

7. Attach the speakers to the hook and loop fasteners for speakers inside the helmet.

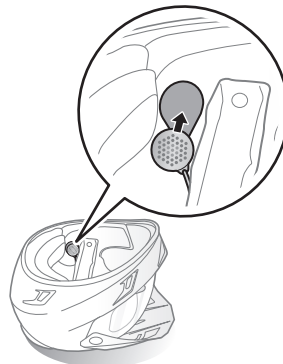

- Place the FM antenna between the outer shell and the comfort lining around the top shell of the helmet. Make sure the end of the FM antenna is placed at front left part of the helmet away from the antenna.

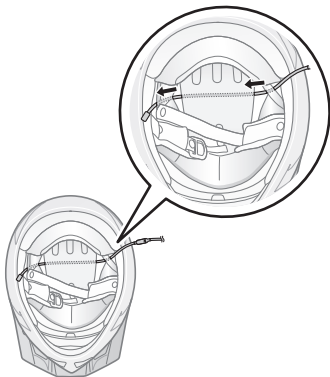

- Reinstall the cheek pads and the neckroll.

## 4 GETTING STARTED

### 4.1 Button Operation

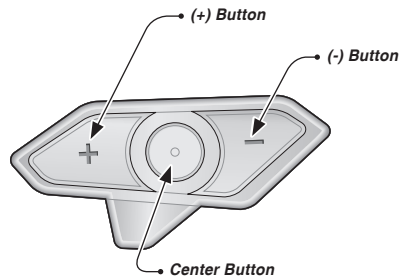

### 4.2 Powering On and Off

To power on the headset, press the Center Button and the (+) Button at the same time while hearing ascending beeps and a voice prompt, **“Hello”**. To power off the headset, press the Center Button and the (+) Button at the same time while hearing descending beeps and a voice prompt, **“Goodbye”**.

### 4.3 Charging

You can charge the headset by connecting the supplied USB power & data cable into a computer's USB port or USB wall charger. You can use any standard micro USB cable to charge the unit. You can also charge it on the road using the cigarette charger. The charging LED turns red while charging and turns blue when fully charged. It takes about 2.5 hours to be completely charged.

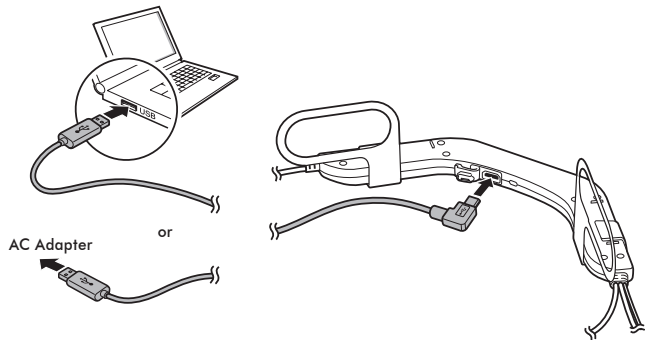

### 4.4 Checking the Battery Level

#### 4.4.1 LED Indicator

When the headset is powering on, the red LED flashes rapidly indicating the battery level.

4 flashes = High, 70 ~ 100%

3 flashes = Medium, 30 ~ 70%

2 flashes = Low, 0 ~ 30%

#### 4.4.2 Voice Prompt Indicator

When you power on the headset, keep pressing the Center Button and the (+) Button simultaneously for about 3 seconds until you hear three, high toned beeps. Then you will hear a voice prompt indicating the battery level. However, if you release the buttons as soon as the headset turns on, you will not hear a voice prompt for the battery level indication.

## 4.5 Volume Adjustment

You can easily adjust the volume by tapping the (+) Button or the (-) Button. You will hear a beep when the volume reaches the maximum or minimum level. The volume is set and maintained independently at different levels for each audio source even when you reboot the headset. For example, once you set the volume for mobile phone handsfree, it will not change even if you adjust the volume for your Bluetooth MP3 music. However, if you adjust the volume during stand-by mode, it will affect volume levels of every audio source.

## 4.6 Sena Softwares

### 4.6.1 Sena Device Manager

The Sena Device Manager allows you to upgrade the firmware and configure the device settings directly from your PC. Using this software, you can assign speed dial presets, FM radio frequency presets and more. It is available for both Windows and Mac. For more information on downloading the Device Manager, please visit [oemsena.com/oem-klim/](http://oemsena.com/oem-klim/).

### 4.6.2 Sena Smartphone App

The Sena Smartphone App allows you to configure device settings and read the User's Guide and the Quick Start Guide. Pair your phone with your 10U headset (please refer to *section 5.1, "Mobile Phone Pairing - Mobile Phone, Bluetooth Stereo Device"*). Run the Sena Smartphone App and you can configure its settings directly from your smartphone. You can download the Sena Smartphone App for Android or iPhone from [www.sena.com/headset-app](http://www.sena.com/headset-app).

## 5 PAIRING THE 10U WITH BLUETOOTH DEVICES

Before using the 10U Bluetooth headset with any other Bluetooth devices for the first time, you will need to pair them together. You can pair the 10U with Bluetooth mobile phones, Bluetooth stereo devices such as MP3 players, or motorcycle specific Bluetooth GPS navigation, and with other Sena Bluetooth headsets. The pairing operation is required only once for each Bluetooth device. The headset remains paired with the devices and automatically reconnects to them when they are within range. You will hear a high toned single beep and a voice prompt whenever the headset reconnects to the paired device: **“Phone connected”** to a mobile phone, **“Media connected”** to a Bluetooth stereo device.

### 5.1 Mobile Phone Pairing - Mobile Phone, Bluetooth Stereo Device

1. Press and hold the Center Button for 10 seconds until you hear the voice prompt, **“Configuration menu”**.
2. Tap the (+) Button until you hear a voice prompt, **“Phone pairing”**.
3. Search for Bluetooth devices on your mobile phone. Select the 10U in the list of the devices detected on the mobile phone.
4. Enter 0000 for the PIN. Some mobile phones may not ask for the PIN.
5. The mobile phone confirms that pairing has completed and the 10U is ready to use. You will hear a voice prompt, **“Your headset is paired”**.
6. If the pairing process is not completed within three minutes, the 10U will return to stand-by mode.

#### Note:

1. If a Bluetooth connection between the headset and a mobile phone is disconnected, press the Center Button for 3 seconds until you hear a high tone single beep to recover the Bluetooth connection immediately.
2. If the Bluetooth connection between the headset and a media player is disconnected, press the Center Button for 1 second to recover the Bluetooth connection and play.

## 5.2 Second Mobile Phone Pairing - Second Mobile Phone, GPS, and SR10

Typical Bluetooth headsets can connect with only one Bluetooth device, but a second mobile phone pairing allows the headset to connect with another Bluetooth device such as a second mobile phone, an MP3 Player, or the Sena SR10, the Bluetooth adapter.

1. To enter the voice configuration menu, press and hold the Center Button for 10 seconds until you hear the voice prompt, **“Configuration menu”**.
2. Tap the (+) Button until you hear a voice prompt, **“Second mobile phone pairing”**.
3. Search for Bluetooth devices on your mobile phone. Select the 10U in the list of the devices detected on the mobile phone.
4. Enter 0000 for the PIN. Some mobile phones may not ask for the PIN.
5. The mobile phone confirms that the pairing has completed and the 10U is ready to use. You will hear a voice prompt, **“Your headset is paired”**.

### Note:

1. *If you have two audio (A2DP) devices connected to your headset then the audio from one device will interrupt the audio from the other device. For example, if you are playing music from the primary mobile phone, then it can be interrupted by playing music from the secondary mobile phone and vice versa.*
2. *You have to use a motorcycle specific GPS, which transmits turn-by-turn voice instructions to the headset by Bluetooth. Most automotive GPS systems do not have this feature.*
3. *The Sena SR10 is a Bluetooth two-way radio adapter for group communication, and uses Hands-Free Profile. The incoming audio from the two-way radio via SR10 is heard in the background while having an intercom conversation or a mobile phone call.*
4. *The GPS navigation or a radar detector could be connected to the SR10 by wire. The GPS voice instruction or the radar detector alarm is also heard in the background via SR10 while having an intercom conversation or a phone call. Please refer to the SR10 User's Guide for details.*

### 5.3 Advanced Selective Pairing - A2DP Stereo or Handsfree

When you are using a smartphone, sometimes you may need to selectively use the 10U for A2DP stereo music only or for mobile phone handsfree only. These instructions are for advanced users who want to pair the 10U to their smartphones with only one selective profile: A2DP for stereo music or HFP for phone calls.

If you have previously paired a mobile phone to the 10U, you must clear the previous pairing list on both devices: the mobile phone and the 10U. To clear the pairing list on the 10U, please do a factory reset or following the pairing list clearing procedure described in *section 14.18, "Factory Reset"* or *14.15, "Delete All Bluetooth Pairing Information"*. To clear the pairing list on the mobile phone, please refer to the mobile phone manual. For most smartphones, delete the 10U from the list of Bluetooth devices in the settings menu.

#### 5.3.1 A2DP Stereo Music Only

1. To enter the voice configuration menu, press and hold the Center Button for 10 seconds until you hear the voice prompt, **"Configuration menu"**.
2. Tap the (+) Button until you hear the voice prompt, **"Media selective pairing"**.
3. Search for Bluetooth devices on your smartphone. Select the 10U in the list of devices detected on your phone.
4. Enter 0000 for the PIN. Some mobile phones may not ask for the PIN.

#### 5.3.2 HFP for Phone Call Only

1. To enter the voice configuration menu, press and hold the Center Button for 10 seconds until you hear the voice prompt, **"Configuration menu"**.
2. Tap the (+) Button until you hear the voice prompt, **"Phone selective pairing"**.
3. Search for Bluetooth devices on your smartphone. Select the 10U in the list of devices detected on your phone.
4. Enter 0000 for the PIN. Some mobile phones may not ask for the PIN.



## 5.4 Intercom Pairing

### 5.4.1 Pairing with Other 10U Headsets for Intercom Conversation

The 10U can be paired with up to three other headsets for Bluetooth intercom conversation.

1. Turn on the two 10U headsets (A and B) that you would like to pair with each other.
2. Press and hold the Center Button for 5 seconds, then you will hear a mid-tone single beep and the voice prompt, “**Intercom pairing**”.

3. Simply tap the Center Button of any one of the two headsets A or B and wait until the LEDs of both headsets turn to blue and intercom connection is automatically established. The two 10U headsets A and B are paired with each other for intercom conversation. If the pairing process is not completed within one minute, the 10U will return to stand-by mode.

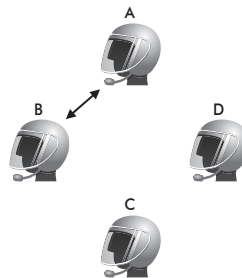

**Pairing A & B**

4. You can make other pairing between headsets A and C, and between headsets A and D by following the same procedure as above.
5. The intercom pairing queue is '**Last-Come, First-Served**'. If a headset has multiple paired headsets for intercom conversations, the last paired headset is set as **first intercom friend**. The previous intercom friend becomes **second intercom friend**, and **third intercom friend**.

*Note:*

*For example, after the pairing procedures listed above, headset D is the **first intercom friend** of headset A. Headset C is the **second intercom friend** of headset A, and headset B is the **third intercom friend** of headset A.*

#### **5.4.2 Pairing with Other Sena Headset Models for Intercom Conversation**

The 10U can be paired with all other Sena headset models such as the 20S, SMH10 and the SMH5 for intercom conversation. Please follow the same procedure as above to pair with these headset models.

*Note:*

*The SMH5 cannot participate in three-way or four-way conference intercom with the 10U. The SMH5 has a limited capability of having two-way intercom with other Sena headsets.*

## 6 MOBILE PHONE, GPS, SR10

### 6.1 Mobile Phone Call Making and Answering

1. When you have an incoming call, tap the Center Button to answer the call.
2. You can also answer the incoming call by loudly speaking any word of your choice if *Voice Activated Phone Answering* (VOX Phone) is enabled, unless you are connected to intercom.
3. To end a call, press the Center Button for 2 seconds until you hear a mid-tone single beep, or wait for the called person to end the call.
4. To reject a call, press the Center Button for 2 seconds until you hear a beep while the phone is ringing.
5. There are several ways to make a phone call:
  - Enter numbers on your mobile phone's keypad and make a call. Then the call is automatically transferred to the headset.
  - In stand-by mode, press the Center Button for 3 seconds, to activate the voice dialing of your mobile phone. For this, the voice dialing function must be available on the mobile phone. Refer to your mobile phone manual for further instruction.

#### Note:

1. *If you have two phones connected to your headset and you have an incoming call from the second phone during the call of the first phone, then you may still receive the call from the second phone. In this case, the call from the first phone is on waiting mode. If you end a call, then it will automatically guide you to the first phone call.*
2. *If you have a mobile phone and a GPS connected to your headset, you may not be able to listen to the GPS voice instruction during the phone call.*

## 6.2 Speed Dialing

You can quickly make a phone call by using the voice speed dial menu.

1. To enter into the voice speed dial menu, press and hold the (+) Button for 3 seconds and you will hear a mid-tone single beep and a voice prompt saying **“Speed dial”**.
2. Tap the (+) Button or the (-) Button to navigate between the menus. You will hear voice prompts for each menu item.
3. Tap the Center Button to select a voice menu among the followings:

**(1) Last number redial**

**(4) Speed dial 3**

**(2) Speed dial 1**

**(5) Cancel**

**(3) Speed dial 2**

4. After selecting the last number redial menu, you will hear a voice prompt, **“Last number redial”**. Then, to redial the last phone call number, tap the Center Button.
5. To call one of the speed dials, tap the (+) Button or the (-) Button to navigate between the menus until you hear a voice prompt saying **“Speed dial (#)”**. Then, tap the Center Button.
6. If you want to exit the speed dial immediately, tap the (+) Button or the (-) Button until you hear a voice prompt saying **“Cancel”**, and tap the Center Button. If you do not press any button within 15 seconds, the 10U will exit the voice speed dial menu and go back to stand-by mode.

### Note:

1. Make sure that you connect the mobile phone and the headset to use the speed dial function.
2. You need to assign speed dial numbers before using the speed dial (please refer to section 14.5, “Assigning Speed Dial”).

### 6.3 GPS Navigation

If you pair a Bluetooth GPS to the 10U as described in *section 5.2, "Second Mobile Phone Pairing - Second Mobile Phone, GPS, and SR10"*, you can listen to GPS instructions wirelessly. Tap the (+) Button or the (-) Button to adjust volume. The GPS voice instruction interrupts intercom conversation but it is automatically reestablished after the GPS voice instruction ends.

### 6.4 Sena SR10, Two-Way Radio Adapter

You can use a two-way radio and the 10U Bluetooth intercom simultaneously by using the Sena SR10, a Bluetooth Two-way Radio Adapter (please refer to *section 5.2, "Second Mobile Phone Pairing - Second Mobile Phone, GPS, and SR10"*). Incoming audio from the two-way radio will not interrupt an intercom conversation but is heard in the background. This is useful when you have an intercom conversation with a passenger on the back seat and use a two-way radio for group communication with other motorcycle riders.

## 7 STEREO MUSIC

### 7.1 Bluetooth Stereo Music

The Bluetooth audio device must be paired with the 10U by following the *"Mobile Phone Pairing - Mobile Phone, Bluetooth Stereo Device"* procedures described in the *section 5.1*. The 10U supports the Audio/Video Remote Control Profile (AVRCP), so if your Bluetooth audio device also supports the AVRCP, you can use the 10U to remotely control music playback. Not only can you adjust the volume but you can also use functions such as play, pause, next track and previous track.

1. To play or pause music, press the Center Button for 1 second until you hear a double beep.
2. To adjust the volume, tap the (+) Button or the (-) Button.
3. To track forward or track back, press and hold the (+) Button or the (-) Button for 1 second until you hear a mid-tone single beep.

## 7.2 Music Sharing

You can start sharing music with an intercom friend using Bluetooth stereo music during a two-way intercom conversation (please refer to *section 8.1, "Two-way Intercom"*). When you terminate music sharing, you can go back to the intercom conversation. To start or terminate sharing music, press the Center Button for 1 second during an intercom conversation until you hear a double beep. To track forward or track back, press and hold the (+) Button or the (-) Button for 1 second.

*Note:*

1. Both you and your intercom friend can remotely control music playback such as track forward and track back.
2. Music sharing will be paused when you are using your mobile phone or listening to GPS instructions.

## 8 INTERCOM

Please make sure your intercom devices are paired as described in *section 5.4, "Intercom Pairing"*

### 8.1 Two-way Intercom

#### 8.1.1 Starting Two-way Intercom

You can start an intercom conversation with one of any intercom friends by tapping the Center Button. Tap the Center Button once to intercom with the **first intercom friend**, tap the Center Button twice to intercom with the **second intercom friend**, and tap the Center Button three times to intercom with the **third intercom friend**.

### 8.1.2 Ending Two-way Intercom

You can end an intercom conversation by using the Center Button. Press and hold the Center Button for 1 second to end any intercom. Or, you can single tap to end intercom with the **first intercom friend**, double tap to end intercom with the **second intercom friend**, and triple tap to end intercom with the **third intercom friend**.



**Start/End Two-way Intercom Conversation**

## 8.2 Three-way Intercom

### 8.2.1 Starting Three-way Intercom

You (A) can have a three-way conference intercom with two other 10U friends (B & C) by establishing two intercom connections simultaneously. While a three-way conference intercom is in progress, mobile phone connection of all three participants is temporarily disconnected. However, as soon as the conference intercom terminates or one of the participants leaves the intercom, all mobile phones automatically reconnect to their headsets. If you have an incoming mobile phone call during the conference intercom, terminate the conference intercom to automatically reconnect and receive the phone call.

1. You (A) need to be paired with two other friends (B & C) for three-way conference intercom.

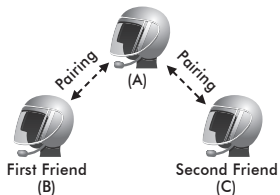

2. Start an intercom conversation with one of the two friends in your intercom group. For example, you (A) may start an intercom conversation with the intercom friend (B). Or intercom friend (B) may start an intercom call with you (A).

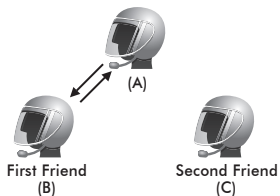

3. You (A) can call the second intercom friend (C) by double tapping the Jog Dial, or the second intercom friend (C) may join the intercom by making an intercom call to you (A).

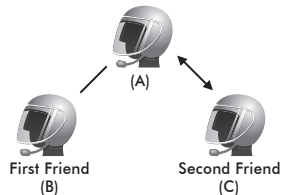

4. Now you (A) and two 10U intercom friends (B & C) are having a three-way conference intercom.

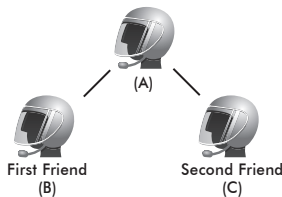



### 8.2.2 Ending Three-way Intercom

You can completely terminate the conference intercom or just disconnect an intercom connection with one of your active intercom friends.

1. Press the Center Button for 1 second until you hear a beep to terminate three-way conference intercom completely. It terminates both intercom connections with (B) and (C).
2. Tap or double tap the Center Button to disconnect intercom connection with one of the two intercom friends accordingly. For example, by single tapping the Center Button, you can terminate the intercom connection with just the first intercom friend (B). However, you still have the intercom connection with your second intercom friend (C).

Center Button Operation	Result
Press for 1 second	Disconnect (B) & (C)
Single tap	Disconnect (B)
Double tap	Disconnect (C)

#### End Three-way Intercom

### 8.3 Four-way Intercom

#### 8.3.1 Starting Four-way Intercom

You can have four-way conference intercom with three other 10U users by adding one more intercom participant to the three-way intercom. While you are having a three-way intercom as above in *section 8.2, "Three-way Intercom"*, a new participant (D), who is an intercom friend of your intercom friend (C), may join the conference intercom by making an intercom call to your intercom friend (C). Please note that in this case, the new participant (D) is an intercom friend of (C), not of you (A).

#### 8.3.2 Ending Four-way Intercom

As same in the case of three-way intercom, you can completely get out of the four-way conference intercom or just disconnect a single intercom connection.

1. Press the Center Button for 1 second until you hear a beep to terminate four-way conference intercom. It terminates the intercom connections between you (A), and your intercom friends (B) and (C).

2. Tap or double tap the Center Button to disconnect the intercom connection with one of the two intercom friends accordingly. However, when you disconnect the second friend (C) by double tapping the Center Button, you will be disconnected with the third participant (D) as well. This is because the third participant (D) is connected with you via the second friend (C).

Center Button Operation	Result
Press for 1 second	Disconnect (B), (C) & (D)
Single tap	Disconnect (B)
Double tap	Disconnect (C) & (D)

**End Four-way Intercom**

*Note:*

*Multiple headsets are connected during multi-way intercom. With various signals interfering each other, the intercom distance of multi-way intercom is relatively shorter than that of two-way intercom.*

## 9 THREE-WAY CONFERENCE PHONE CALL WITH INTERCOM PARTICIPANT

1. When you have an incoming mobile phone call during an intercom conversation, you will hear a ring tone. You can choose whether to 1) *answer the mobile phone call and stop the intercom conversation, or 2) reject the phone call and stay on the intercom conversation.*
  - 1) To answer the phone call and stop the intercom conversation, tap the Center Button. The VOX Phone feature does not work if you are connected to intercom. When you hang up the phone call, the intercom will automatically be recovered.
  - 2) To reject the phone call and stay on the intercom conversation, press the Center Button for 2 seconds until you hear a beep.

Unlike other motorcycle Bluetooth headsets, this prevents a user from being dropped out of an intercom conversation by an incoming mobile call.

2. When you have an incoming intercom call during a mobile phone call, you will hear 4 high toned beeps, alerting you that there is an incoming intercom call. You will also hear a voice prompt, **“Intercom requested”**. In this case, the intercom call does not override the mobile call because intercom has lower priority than mobile call. You have to hang up the mobile phone call to make or receive an intercom call.
3. You can have a three-way conference phone call by adding an intercom friend to the mobile phone conversation. During a mobile phone conversation, tap the Center Button to invite one of the intercom friends to the mobile phone line. To disconnect the intercom first and go back to your private mobile phone call, terminate the intercom by tapping the Center Button. To end the mobile phone call first and maintain the intercom conversation, tap the Center Button for 2 seconds, or wait for the person on the mobile phone line to end the call.

Start	Tap the Center Button while having a mobile phone call
End intercom first	Tap the Center Button
End phone call first	Tap the Center Button for 2 seconds or Wait for the called person to end the call

#### **Start & End Three-way Conference Phone Call**

## 10 GROUP INTERCOM

Group Intercom allows you to instantly create a multi-way conference intercom with three other most recently paired headsets.

1. Go through intercom pairing with up to three headsets you want to have Group Intercom with.
2. Tap the (+) Button and (-) Button simultaneously to begin Group Intercom. The LED will flash blue and red simultaneously and you will hear a voice prompt, **“Group intercom”**.
3. To terminate Group Intercom, press the Center Button for 1 second during Group Intercom. You will hear a voice prompt, **“Group intercom terminated”**.

*Note:*

*Group Intercom supports 10U, 10C, 10R, 10S and 20S only. Other headsets will be excluded from Group Intercom.*

## 11 UNIVERSAL INTERCOM

You can have an intercom conversation with non-Sena Bluetooth headsets using the Universal Intercom function. Non-Sena Bluetooth headsets can be connected to the Sena Bluetooth headset if they support the Bluetooth Hands-Free Profile (HFP). The working distance may differ depending on the performance of Bluetooth headset that it is connected to. In general, it is shorter than normal intercom distance since it uses the Bluetooth Hands-Free Profile. The Universal Intercom affects both the phone call connection and the multipoint connection (mostly used for GPS connections for riders). You cannot use a multipoint connection device while you are using the Universal Intercom in case as below.

1. If a non-Sena headset does not support a multipoint connection, it cannot use a phone call connection while using the Universal Intercom.
2. As for Sena headsets, the Universal Intercom affects the multipoint connection.
3. If non-Sena headset (already paired as Universal Intercom with Sena) is turned on, then the multipoint connection is automatically deactivated. And the non-Sena headset is automatically connected to Sena headset as a Universal Intercom. So you cannot use multipoint connection devices such as GPS, while a non-Sena headset is turned on.
4. Even though you disconnect the non-Sena headset as a Universal Intercom, it will not automatically restore the multipoint connection. To restore the multipoint connection, you should turn off the non-Sena headset first, then try to connect to multipoint device manually from the device screen or simply reboot the device so that it automatically connects to the Sena headset.

## 11.1 Universal Intercom Pairing

The 10U can be paired with non-Sena Bluetooth headsets for Bluetooth intercom conversation. You can pair the 10U with only one non-Sena Bluetooth headset so if you pair with a different non-Sena Bluetooth headset, the previous pairing will be removed.

1. Turn on the 10U and a non-Sena Bluetooth headset that you want to pair with.
2. Press and hold the Center Button for 10 seconds to enter the configuration menu. Tap the (+) Button or the (-) Button until you hear a voice prompt, **“Universal intercom pairing”**. Tap the Center Button to enter into Universal Intercom Pairing mode and the blue LED will flash rapidly and you will hear multiple beeps. Please refer to *section 14.17, “Universal Intercom Pairing”* for more details.
3. Perform the operation required for handsfree pairing on the non-Sena Bluetooth headset (refer to the User’s Manual for the headsets you want to use). The 10U will automatically pair with a non-Sena Bluetooth headset when each are in pairing mode.

## 11.2 Two-way Universal Intercom

You can initiate the Universal Intercom connection with non-Sena Bluetooth headsets using the same intercom connection method as you would between other Sena headsets. You may single tap the Center Button to begin an intercom conversation with the first intercom friend, double tap with the second intercom friend, and triple tap with the third intercom friend.

Non-Sena Bluetooth headsets may initiate the Universal Intercom connection, by activating the voice dialer or using the redialing operation. You may also disconnect the existing connection by using the operation to end a call (refer to *the User's Manual for the headsets* for voice dialer, redialing, and ending a call).

## 11.3 Three-way Universal Intercom

You may make a three-way Universal Intercom connection with two 10Us and one non-Sena Bluetooth headset. If the intercom connection is made, all headsets connected cannot use the mobile phone call function since the connection between the headset and the phone is disconnected temporarily. If you disconnect the intercom call, the mobile phone connection is made again automatically so that you can use a mobile phone call function.

1. You (A) need to be paired with a non-Sena Bluetooth headset (B) and another 10U headset (C) for the three-way conference intercom.

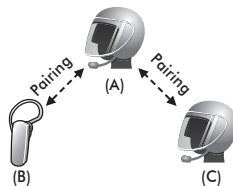

2. Start an intercom conversation with non-Sena Bluetooth headset (B) in your intercom group. For example, you (A) may start an intercom conversation with non-Sena Bluetooth headset (B). The non-Sena Bluetooth headset (B) may also start an intercom call with you (A).

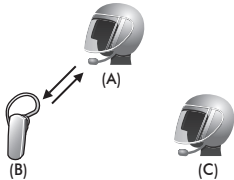

3. The other 10U (C) may join the intercom by making an intercom call to you (A).

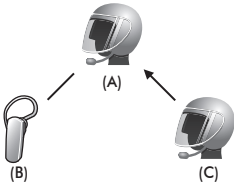

4. Now you (A), non-Sena Bluetooth headset (B), and the other 10U (C) are having a three-way conference intercom.

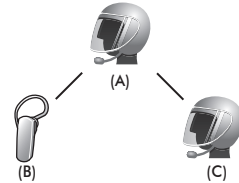

5. You may disconnect three-way Universal Intercom using the same way as you do in normal three-way intercom. Please refer to *section 8.2.2, "Ending Three-way Intercom"*.

## 11.4 Four-way Universal Intercom

You may make a four-way Universal Intercom connection with a couple of different configurations, 1) *three 10Us and one non-Sena Bluetooth headset* or 2) *two 10Us and two non-Sena Bluetooth headsets*.

You may have a couple of other Four-way Universal Intercom configurations, 1) *your headset (A), a non-Sena Bluetooth headset (B), another 10U (C), and a non-Sena Bluetooth headset (D)*, 2) *your headset (A), a non-Sena Bluetooth headset (B), and two other 10U headsets (C and D)*. You may make the four-way Universal Intercom call the same way as a normal four-way intercom call.

### 11.4.1 Four-way Universal Intercom Case 1

Two 10U headsets (A and C) and two non-Sena Bluetooth headsets (B and D).

1. You (A) may start an intercom conversation with the non-Sena Bluetooth headset (B).

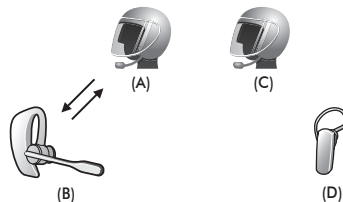

2. The other 10U (C) may join the intercom by making an intercom call to you (A).

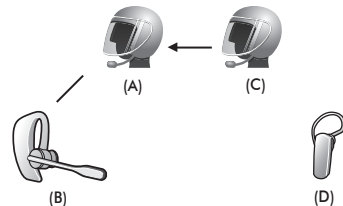



3. The non-Sena Bluetooth headset (D) may join the conference intercom by making an intercom call to the 10U (C).

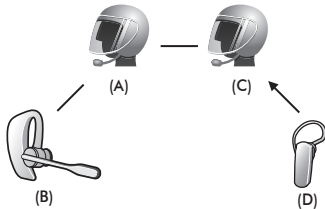

4. Now two 10U headsets (A & C) and two non-Sena Bluetooth headsets (B & D) are connected with the four-way Universal Intercom.

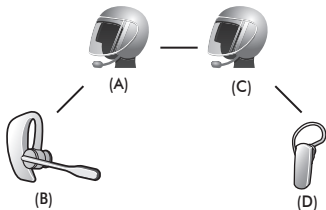

You may disconnect a four-way Universal Intercom using the same way as you do in a normal four-way intercom. Please refer to *section 8.3.2, "Ending Four-way Intercom"*.

#### 11.4.2 Four-way Universal Intercom Case 2

Three 10U headsets (A, C and D) and one non-Sena Bluetooth headset (B). The procedure is the same as case 1 described in *section 11.4.1*.

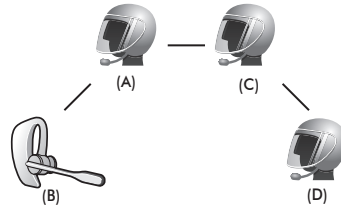

## 12 FM RADIO

### 12.1 FM Radio On and Off

To turn on the FM radio, press the (-) Button for 1 second until you hear a mid-toned double beep sound. You will then hear a voice prompt, **“FM on”**. To turn off the FM radio, press the (-) Button for 1 second until you hear a voice prompt, **“FM off”**. When you power it off, the 10U will remember the last station frequency. When you power it on, the last station frequency will be playing.

### 12.2 Preset Stations

You can listen to preset stations while listening to the FM radio. Press the Center Button for 1 second to go upward to your next saved preset station.

### 12.3 Seek and Save

“Seek” is the function that searches for station to station frequencies. To use the “Seek” function, please follow the procedure below:

1. Double tap the (+) Button or the (-) Button to search down or up the station dial.
2. If the tuner finds a station while searching frequencies, it stops the seek function.
3. To save the current station, press and hold the Center Button for 3 seconds until you hear a voice prompt, **“Preset (#)”**.
4. Tap the (+) Button or the (-) Button in order to select which preset number you want for that specific station. You can save up to 10 preset stations. (You may cancel the preset operation by waiting approximately 10 seconds. You will then hear **“Save preset cancelled”**. You can also tap the (+) Button or the (-) Button until you hear **“Cancel”**. Tap the Center Button to confirm cancellation. You will then hear **“Save preset cancelled”**.)
5. To save the current station, press the (+) Button for 1 second. You will then hear a voice prompt, **“Save preset (#)”**.
6. To delete the saved station in the preset number, press the (-) Button for 1 second. You will then hear a voice prompt, **“Delete preset (#)”**.

*Note:*

- 1. You can save FM stations to presets before using FM radio. Connect the 10U to your PC and open the Sena Device Manager. It allows you to save up to 10 FM station frequency presets on the 10U settings menu. You may do the same operation by using the Sena Smartphone App.*
- 2. You can still answer an incoming phone call and intercom while listening to the FM radio.*

## 12.4 Scan and Save

“Scan” is the function that automatically searches station frequencies, starting from the current frequency and up. To use the scan function, please follow the procedures below:

1. Press the (+) Button for 1 second. Then the current station frequency moves upward to find other station frequencies.
2. If the tuner finds a station, it stays at the station frequency for 8 seconds, then scanning to the next station frequency.
3. Scan function stops when you press the (+) Button for 1 second again.
4. To save a station while scanning frequencies, tap the Center Button when at that station. You will hear a voice prompt from the 10U, **“Save preset (#)”**. The station will be saved as the next preset number.
5. All stations preset during “Scan”, will overwrite previously set stations.

## 12.5 Temporary Preset

With the temporary preset function, you may temporarily preset stations automatically without changing the existing preset stations. Tap the (+) Button three times to automatically scan for 10 temporary preset stations. The temporary preset stations will be cleared when the system is powered off.

## 12.6 Region Selection

You can select the proper FM frequency region from the Sena Device Manager. With the region setting, you may optimize the seek function to avoid unnecessary frequency ranges (factory default: worldwide).

Region	Frequency Range	Step
Worldwide	76.0 ~ 108.0 MHz	± 100 kHz
Americas	87.5 ~ 107.9 MHz	± 200 kHz
Asia	87.5 ~ 108.0 MHz	± 100 kHz
Australia	87.5 ~ 107.9 MHz	± 200 kHz
Europe	87.5 ~ 108.0 MHz	± 100 kHz
Japan	76.0 ~ 95.0 MHz	± 100 kHz

## 13 FUNCTION PRIORITY

The 10U operates in the following order of priority:

**(highest)**

Mobile phone

Intercom

Music sharing by Bluetooth stereo music

FM Radio

**(lowest)**

Bluetooth stereo music

A lower priority function is always interrupted by a higher priority function. For example, stereo music is interrupted by intercom call, and an intercom conversation is interrupted by an incoming mobile phone call.

## 14 CONFIGURATION SETTING

You can set the configuration of the 10U by the voice menu instruction described below.

1. To enter into voice configuration menu, press and hold the Center Button for 10 seconds until the LED shows solid blue and you hear high toned double beeps. You will also hear a voice prompt, “**Configuration menu**”.
2. Tap the (+) Button or the (-) Button to navigate between the menus. You will hear voice prompts for each menu item as below.
3. You can enable/disable a feature or execute a command by tapping the Center Button.
4. If no button is pressed within 10 seconds, the 10U will exit the configuration and go back to stand-by mode.
5. If you want to exit the configuration immediately, tap the (+) Button or the (-) Button until you hear a voice prompt, “**Exit configuration**”, and tap the Center Button.

The voice prompt for each menu item is as below:

- |  |  |
|--|--|
| <i>(1) Phone pairing</i>               | <i>(11) RDS AF setting</i>             |
| <i>(2) Second mobile phone pairing</i> | <i>(12) FM Station Guide</i>           |
| <i>(3) Phone selective pairing</i>     | <i>(13) Sidetone</i>                   |
| <i>(4) Media selective pairing</i>     | <i>(14) Noise control</i>              |
| <i>(5) Speed dial</i>                  | <i>(15) Delete all pairings</i>        |
| <i>(6) Audio Boost</i>                 | <i>(16) Remote control pairing</i>     |
| <i>(7) VOX phone</i>                   | <i>(17) Universal intercom pairing</i> |
| <i>(8) VOX intercom</i>                | <i>(18) Factory reset</i>              |
| <i>(9) HD intercom</i>                 | <i>(19) Exit configuration</i>         |
| <i>(10) Voice prompt</i>               |  |



Phone pairing
Second mobile phone pairing
Phone selective pairing
Media selective pairing
Speed dial
Audio Boost
VOX phone
VOX intercom
HD intercom
Voice prompt
RDS AF setting
FM Station Guide
Sidetone
Noise control
Delete all pairings
Remote control pairing
Universal intercom pairing
Factory reset
Exit configuration

### 14.1 Mobile Phone Pairing

Voice Prompt	<b>“Phone pairing”</b>
Factory Default	N/A

To go into mobile phone pairing mode, tap the (+) Button or the (-) Button until you hear the voice prompt, **“Phone pairing”**. Please refer to *section 5.1, “Mobile Phone Pairing - Mobile Phone, Bluetooth Stereo Device”* for details on mobile phone pairing. If you tap the (+) Button or the (-) Button, you can exit from the phone pairing mode.

### 14.2 Second Mobile Phone Pairing

Voice Prompt	<b>“Second mobile phone pairing”</b>
Factory Default	N/A

To go into second mobile phone pairing mode, tap the (+) Button or the (-) Button until you hear the voice prompt, **“Second mobile phone pairing”**. Please refer to *section 5.2, “Second Mobile Phone Pairing - Second Mobile Phone, GPS, and SR10”* for details on second mobile phone pairing. If you tap the (+) Button or the (-) Button, you can exit from the second mobile phone pairing mode.

### 14.3 Phone selective pairing

Voice Prompt	<b>“Phone selective pairing”</b>
Factory Default	N/A

To go into phone selective pairing mode, tap the (+) Button or the (-) Button until you hear the voice prompt, **“Phone selective pairing”**. Please refer to *section 5.3.2, “HFP for Phone Call Only”* for details on phone selective pairing. If you tap the (+) Button or the (-) Button, you can exit from the phone selective pairing mode.

### 14.4 Media Selective Pairing

Voice Prompt	<b>“Media selective pairing”</b>
Factory Default	N/A

To go into media selective pairing mode, tap the (+) Button or the (-) Button until you hear the voice prompt, **“Media selective pairing”**. Please refer *section 5.3.1, “A2DP Stereo Music Only”* for details on media selective pairing. If you tap the (+) Button or the (-) Button, you can exit from the media selective pairing mode.

### 14.5 Assigning Speed Dial

Voice Prompt	<b>“Speed dial”</b>
Factory Default	N/A
Execute	Tap the Center Button

1. To assign a phone number as a speed dial, tap the (+) Button or the (-) Button until you hear a voice prompt, **“Speed dial”**.
2. Tap the Center Button, and you will hear a voice prompt, **“Speed dial one”** and **“Phone connected”**.
3. Tap the (+) Button or the (-) Button to select one of three speed dial numbers and you hear a voice prompt, **“Speed dial (#)”**.
4. Call a phone number you want to assign and you will hear a voice prompt, **“Save speed dial (#)”**. The phone number is automatically assigned to the selected speed dial number. Then the phone call will hang up before being connected.
5. To exit the menu, tap the (+) Button or the (-) Button until you hear a voice prompt, **“Cancel”**, and tap the Center Button to confirm. You will then hear a voice prompt, **“Cancel”**. If no button is pressed within 1 minute, the 10U will exit the configuration menu and go back to stand-by mode.

*Note:*

1. After assigning a phone number to one of three speed dials, you can continually assign another phone number to the rest of two speed dials.
2. You can also assign phone numbers for speed dialing by using the Sena Device Manager software or the Sena Smartphone App. Please visit the Sena Bluetooth website at [www.sena.com](http://www.sena.com) for more information.

### 14.6 Enabling/Disabling Audio Boost

Voice Prompt	“Audio boost”
Factory Default	Disable
Enable/Disable	Tap the Center Button

Enabling Audio Boost increases the overall maximum volume. Disabling Audio Boost reduces the overall maximum volume, but delivers more balanced sound.

### 14.7 Enabling/Disabling Voice Activated Phone Answering

Voice Prompt	“VOX phone”
Factory Default	Enable
Enable/Disable	Tap the Center Button

If this feature is enabled, you can answer incoming calls by voice. When you hear a ringtone for an incoming call, you can answer the phone by saying a word such as “Hello” loudly or by blowing air into the microphone. VOX phone is temporarily disabled if you are connected to intercom. If this feature is disabled, you have to tap the Center Button to answer an incoming call.



## 14.8 Enabling/Disabling Voice Activated Intercom

Voice Prompt	“VOX intercom”
Factory Default	Disable
Enable/Disable	Tap the Center Button

If this feature is enabled, you can initiate an intercom conversation with the last connected intercom friend by voice. When you want to start intercom, say a word such as **“Hello”** loudly or blow air into the microphone. If you start an intercom conversation by voice, the intercom terminates automatically when you and your intercom friend remain silent for 20 seconds. However, if you manually start an intercom conversation by tapping the Center Button, you have to terminate the intercom conversation manually.

However, if you start intercom by voice and end it manually by tapping the Center Button, you will not be able to start intercom by voice temporarily. In this case, you have to tap the Center Button to restart the intercom. This is to prevent repeated unintentional intercom connections by strong wind noise. After rebooting the 10U, you can start intercom by voice again.

## 14.9 Enabling/Disabling HD Intercom

Voice Prompt	“HD intercom”
Factory Default	Enable
Enable/Disable	Tap the Center Button

HD Intercom enhances the two-way intercom audio from normal quality to HD quality. HD Intercom will become temporarily disabled when you enter into a multi-way intercom. If this feature is disabled, the two-way intercom audio will change to normal quality.

*Note:*

*The intercom distance of HD Intercom is relatively shorter than that of normal intercom.*

### 14.10 Enabling/Disabling Voice Prompts

Voice Prompt	“Voice prompt”
Factory Default	Enable
Enable/Disable	Tap the Center Button

You can disable voice prompts by configuration setting, but the following voice prompts are always on.

- Voice prompts for configuration setting menu
- Voice prompts for battery level indicator
- Voice prompts for speed dial
- Voice prompts for FM radio functions

### 14.11 Enabling/Disabling RDS AF

Voice Prompt	“RDS AF setting”
Factory Default	Disable
Enable/Disable	Tap the Center Button

RDS AF allows a receiver to re-tune to the second frequency location when the first signal becomes too weak. With RDS AF enabled on the receiver, a radio station with more than one frequency can be used.

### 14.12 Enabling/Disabling FM Station Guide

Voice Prompt	“FM station guide”
Factory Default	Enable
Enable/Disable	Tap the Center Button

When FM Station Guide is enabled, FM station frequencies are given by voice prompts as you select preset stations. When FM Station Guide is disabled, the voice prompts on FM station frequencies will not be given as you select preset stations.

### 14.13 Enabling/Disabling Sidetone

Voice Prompt	“Sidetone”
Factory Default	Disable
Enable/Disable	Tap the Center Button

Sidetone is audible feedback of your own voice. It helps you to naturally speak at the correct level according to varying helmet noise conditions. If this feature is enabled, you can hear what you are speaking during an intercom conversation or a phone call.

#### 14.14 Enabling/Disabling Advanced Noise Control™

Voice Prompt	<b>“Noise control”</b>
Factory Default	Enable
Enable/Disable	Tap the Center Button

When Advanced Noise Control is enabled, the background noise is reduced during an intercom conversation. When it is disabled, the background noise is mixed with your voice during intercom.

**Note:**

*If you use your 10U with the Bluetooth Audio Pack for GoPro, you can enable or disable this feature only during Normal Audio Recording Mode. This feature is automatically disabled while in Ultra HD (UHD) Audio Mode.*

#### 14.15 Delete All Bluetooth Pairing Information

Voice Prompt	<b>“Delete all pairings”</b>
Factory Default	N/A
Execute	Tap the Center Button

To delete all Bluetooth pairing information of the 10U, tap the (+) Button or the (-) Button until you hear a voice prompt, **“Delete all pairings”**, and tap the Center Button to confirm.

#### 14.16 Remote Control Pairing

Voice Prompt	<b>“Remote control pairing”</b>
Factory Default	N/A
Execute	Tap the Center Button

To enter into Remote Control Pairing mode, tap the (+) Button or the (-) Button until you hear a voice prompt, **“Remote control pairing”**. Then tap the Center Button to enter into Remote Control Pairing mode. The headset will automatically exit from the configuration menu.

#### 14.17 Universal Intercom Pairing

Voice Prompt	<b>“Universal intercom pairing”</b>
Factory Default	N/A
Execute	Tap the Center Button

To enter into Universal Intercom Pairing mode, tap the (+) Button or the (-) Button until you hear a voice prompt, **“Universal intercom pairing”**. Then tap the Center Button to enter into Universal Intercom Pairing mode. The headset will automatically exit from the configuration menu.

### 14.18 Factory Reset

Voice Prompt	<b>“Factory reset”</b>
Factory Default	N/A
Execute	Tap the Center Button

To restore factory default settings on the 10U, tap the (+) Button or the (-) Button until you hear a voice prompt, **“Factory reset”**, and tap the Center Button to confirm. The 10U powers off with a voice prompt, **“Headset reset, goodbye”**.

### 14.19 Exit Voice Configuration Menu

Voice Prompt	<b>“Exit configuration”</b>
Factory Default	N/A
Execute	Tap the Center Button

To exit voice configuration menu and get back to stand-by mode, tap the (+) Button or the (-) Button until you hear a voice prompt, **“Exit configuration”**, and tap the Center Button to confirm.

Tap (+) Button or (-) Button	Tap Center Button
Phone Pairing	None
Second Mobile Phone Pairing	None
Phone Selective Pairing	None
Media Selective Pairing	None
Speed Dial	Execute
Audio Boost	Enable/Disable
VOX Phone	Enable/Disable
VOX Intercom	Enable/Disable
HD Intercom	Enable/Disable
Voice Prompt	Enable/Disable
RDS AF Setting	Enable/Disable
FM Station Guide	Enable/Disable
Sidetone	Enable/Disable
Advanced Noise Control	Enable/Disable
Delete All Pairings	Execute
Remote Control Pairing	Execute

Tap (+) Button or (-) Button	Tap Center Button
Universal Intercom Pairing	Execute
Factory Reset	Execute
Exit Configuration	Execute

**Voice Configuration Menu & Button Operations**

## 15 REMOTE CONTROL

You can remotely control the 10U via Bluetooth using the Handlebar Remote. This eliminates the need to take off your hand for button operations. Turn on the Handlebar Remote by tapping the Front Button. The 10U and the Handlebar Remote are paired from the factory and are ready for immediate use.

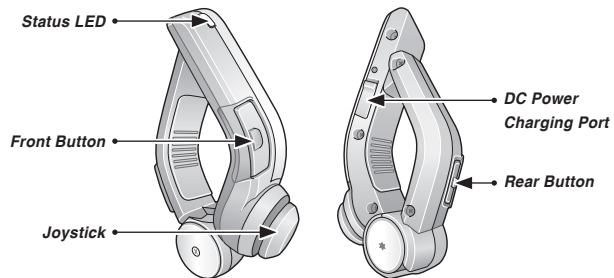

Handlebar Remote

Handlebar Remote button operations on various functions are described in the table below.

Type	Function	Handlebar Remote	LED
Basic Function	Volume adjustment	Move the Joystick up or down	-
	Configuration menu	Press the Front Button for 10 seconds	-
Mobile Phone	Mobile phone pairing	Press the Joystick for 5 seconds	Blue & red alternatively flashing
	Second mobile phone pairing	Press the Front Button for 5 seconds	Red flashing
		Tap the Rear Button within 2 seconds	
	Answer & end phone call	Tap the Rear Button	-
	Voice dial	Tap the Rear Button	-
	Speed dial	Double tap the Rear Button	-
	Reject incoming call	Press the Front Button for 2 seconds	-

Type	Function	Handlebar Remote	LED
Intercom	Intercom pairing	Press the Front Button for 5 seconds	Red flashing
		Tap the Front Button of any one of the two headsets	
	Start/End each intercom	Tap the Front Button	-
	End all intercoms	Press the Front Button for 1 second	-
	Start Group Intercom	Press the Front Button for 3 seconds	Green flashing
	End Group Intercom	Press the Front Button for 1 second	-
Music	Play/Pause Bluetooth music	Press the Joystick for 1 second	-
	Track forward/back	Move the Joystick left or right for 1 second	-
FM radio	FM radio on/off	Press the Rear Button for 1 second	-
	Select preset	Tap the Rear Button	-
	Seek stations	Move the Joystick left or right for 1 second	-
	Scan up FM band	Double tap the Rear Button	-
	Stop scanning	Double tap the Rear Button	-
	Save preset while scanning	Tap the Rear Button	-

**Handlebar Remote Button Operation Table**

## 16 FIRMWARE UPGRADE

The 10U supports firmware upgrades. You can update the firmware using the Sena Device Manager (please refer to *section 4.6.1, "Sena Device Manager"*). Please visit Sena Bluetooth website at [oemsena.com/oem-klim/](https://www.oemsena.com/oem-klim/) to check the latest software downloads.

## 17 TROUBLESHOOTING

### 17.1 Intercom Failure

When you try to start an intercom conversation with an intercom friend who is unavailable within range or already having a conference intercom with other riders or a mobile phone call, you will hear a low tone double beep signifying an intercom busy signal. In this case, you have to try again later.

### 17.2 Intercom Reconnection

If your intercom friend goes out of range while having an intercom conversation, you may hear static noise and eventually the intercom will be disconnected. In this case, the 10U automatically tries to reconnect the intercom every 8 seconds and you will hear high tone double beeps until the intercom is reestablished. If you do not want to make a reconnection, tap the Center Button to stop the attempt.

### 17.3 Fault Reset

When the 10U is not working properly or is in faulty status for any reason, you may reset by pushing the pin-hole reset button as shown in the picture below. Insert a paper clip into the reset pin-hole and press the reset button for a second with light pressure. The 10U will be switched off. Restart the system and try again. This will not restore the headset to factory default settings.



### 17.4 Factory Reset

If you want to restore the headset to factory default settings, use the Factory Reset in the configuration menu. The headset automatically restores the default settings and turns off. Please refer to *section 14.18, "Factory Reset"* for more details.

## 18 QUICK OPERATION REFERENCE

Type	Function	Button Command	LED	Beep
Basic Function	Power on	Press the Center Button and the (+) Button for 1 second	Solid blue	Ascending beeps
	Power off	Tap the Center Button and the (+) Button	Solid red	Descending beeps
	Volume adjustment	Tap the (+) Button or the (-) Button	-	-
Mobile Phone	Answer mobile phone call	Tap the Center Button	-	-
	End mobile phone call	Press the Center Button for 2 seconds	-	-
	Voice dial	Press the Center Button for 3 seconds	-	-
	Speed dial	Press the (+) Button for 3 seconds	-	Mid-tone single beep
	Reject incoming call	Press the Center Button for 2 seconds	-	-
Intercom	Intercom pairing	Press the Center Button for 5 seconds	Red flashing	Mid-tone single beep
		Tap the Center Button of any one of the two headsets		



Type	Function	Button Command	LED	Beep
Intercom	Start/End each intercom	Tap the Center Button	-	-
	End all intercoms	Press the Center Button for 1 second	-	Mid-tone double beeps
	Start Group Intercom	Tap the (+) Button and the (-) Button at the same time	Blue and red flashing	-
	End Group Intercom	Press the Center Button for 1 second	-	-
Music	Play/Pause Bluetooth music	Press the Center Button for 1 second	-	Mid-tone double beeps
	Track forward/back	Press the (+) Button or the (-) Button for 1 second	-	-
FM Radio	FM radio on/off	Press the (-) Button for 1 second	-	Mid-tone double beeps
	Select preset	Press the Center Button for 1 second	-	Mid-tone single beep
	Seek stations	Double tap the (+) Button or the (-) Button	-	High tone triple beeps
	Scan up FM band	Press the (+) Button for 1 second	-	-
	Stop scanning	Press the (+) Button for 1 second	-	High tone double beeps
	Save preset while scanning	Tap the Center Button	-	High tone double beeps

## CERTIFICATION AND SAFETY APPROVALS

### FCC Compliance Statement

This device complies with part 15 of the FCC rules. Operation is subject to the following two conditions:

- (1) This device may not cause harmful interference, and
- (2) This device must accept any interference received, including interference that may cause undesired operation.

This equipment has been tested and found to comply with the limits for a Class B digital device pursuant to part 15 of the FCC rules. These limits are designed to provide reasonable protection against harmful interference in a residential installation. This equipment generates, uses and can radiate radio frequency energy and, if not installed and used in accordance with the instructions, may cause harmful interference to radio communications. However, there is no guarantee that interference will not occur in a particular installation. If this equipment does cause harmful interference to radio or television reception, which can be determined by turning the equipment on and off, the user is encouraged to try to correct the interference by one or more of the following measures:

- Reorient or relocate the receiving antennae
- Increase the separation between the equipment and the receiver

- Connect the equipment into an outlet on a circuit different from that to which the receiver is connected
- Consult the dealer or an experienced radio/TV technician for help

### **FCC RF Exposure Statement**

This equipment complies with FCC radiation exposure limits set forth for an uncontrolled environment. End users must follow the specific operating instructions for satisfying RF exposure compliance. The antenna used for this transmitter must not transmit simultaneously with any other antenna or transmitter, except in accordance with FCC multi-transmitter product procedures.

### **FCC Caution**

Any changes or modifications to the equipment not expressly approved by the party responsible for compliance could void user's authority to operate the equipment.

### **CE Declaration of Conformity**

This product is CE marked according to the provisions of the R&TTE Directive (1999/5/EC). Hereby, Sena declares that this product is in compliance with the essential requirements and other relevant provisions of Directive 1999/5/EC. For further information, please consult [www.sena.com](http://www.sena.com). Please note that this product uses radio frequency bands not harmonized within EU. Within the EU this product is intended to be used in Austria, Belgium, Denmark, Finland, France, Germany, Greece, Ireland, Italy, Luxembourg, The Netherlands, Portugal, Spain, Sweden, United Kingdom and within EFTA in Iceland, Norway and Switzerland.

### **Industry Canada Statement**

This device complies with Industry Canada license-exempt RSS standard(s). Operation is subject to the following two conditions:

- (1) This device may not cause interference.
- (2) This device must accept any interference, including interference that may cause undesired operation of the device.

## Bluetooth License

The Bluetooth® word mark and logos are owned by the Bluetooth SIG, Inc. and any use of such marks by Sena is under license. Other trademarks and trade names are those of their respective owners.

The product is compliant with and adopts the Bluetooth® Specification 4.1 and has successfully passed all interoperability tests that are specified in the Bluetooth® specification. However, interoperability between the device and other Bluetooth®-enabled products is not guaranteed.

## WEEE (Waste Electrical and Electronic Equipment)



The crossed-out wheel bin symbol on the product, literature, or packaging reminds you that all electrical and electronic products, batteries, and accumulators must be taken to separate collection at the end of their working life. This requirement applies to the European Union and other locations where separate collection systems are available. To prevent possible harm to the environment or human health from uncontrolled waste disposal, please do not dispose of these products as unsorted municipal waste, but hand it in at an official collection point for recycling.

## SAFETY INFORMATION

Please ensure that the product is properly used by observing the warnings and cautions below to prevent any risk and/or damage to property.

### Product Storage and Management

- Keep the product free of dust. It may damage mechanical and electronic parts of the product.
- Do not store the product in high temperatures as this may reduce the life span of electronic devices, damage the battery, and/or melt plastic parts of the product.
- Do not store the product in cold temperatures. Abrupt changes in temperatures may cause condensation and damage electronic circuits.
- Do not clean the product with cleaning solvents, toxic chemicals, or strong detergents as this may damage the product.
- Do not paint the product. Paint may obstruct moving parts or interfere with the normal operation of the product.
- Do not drop or otherwise shock the product. It may damage the product or its internal electronic circuits.
- Do not disassemble, repair or modify the product as this may damage the product and invalidate the product warranty.
- Do not store the product in humid environments, especially for long time storage.

## Product Use

- In some regions, it is prohibited by law to ride motorcycles while wearing headsets or earbuds. Therefore be certain to comply with all relevant laws in the region before using the product.
- The headset is for motorcycle helmets only. To install the headset, you must follow the installation instructions shown in the User's Guide.
- Use of the product at a high volume for a long period of time may damage your eardrums or hearing ability. Keep the volume at a modest level to prevent damage.
- Do not cause impact to the product or touch it with sharp tools as this may damage the product.
- Do not use the product in high-temperatures or apply heat to the product as this may cause damage, explosion, or fire.
- Keep product away from pets or small children. It may damage the product.
- In any place where wireless communication is prohibited, such as hospitals or airplanes, turn off the power and refrain from using the product. In a place where wireless communication is prohibited, electromagnetic waves may cause hazards or accidents.
- Do not use the product near hazardous explosives. When it is near any explosion hazards, turn off the power and heed any regulations, instructions, and signs in the area.

- When using the product, be certain to conform to laws regarding the use of communications devices while riding.
- Do not put the product where it may hamper the rider's vision or manipulate it while riding. This may cause traffic accidents.
- Before riding, fasten the product to the helmet, and double-check that it is fastened. Separation of the product while riding may cause damage to the product or accidents.
- If the product is damaged, stop using it immediately. It may cause damage, explosion, or fire.

## Battery

This product has an irreplaceable rechargeable battery inside. Therefore, when using the product, make sure to adhere to the following:

- Never separate the battery from the product as this may damage the product.
- The battery performance may be reduced over time with usage.
- In recharging the battery, make sure to use an approved charger provided by the manufacturer. Use of a non-approved charger may cause fire, explosion, leakage, and other hazards may also reduce the life time or performance of the battery.

- Any 3rd party USB charger can be used with Sena products if the charger is approved by either the FCC, CE, IC or other locally approved agencies that Sena accepts.
- Do not use cigarette chargers other than the included cigarette charger to charge the headset.
- Store the battery at temperatures of 15°C~25°C (59°F~77°F). Higher or lower temperatures may reduce the capacity and life of the battery, or may cause temporary non-operation. Do not use the product in sub-zero temperature, because it may cause serious reduction of the battery performance.
- If you apply heat to the battery or throw it into fire, it may explode.
- Do not use the product with a damaged battery. It may explode and/or cause accidents.
- Never use a damaged charger. It may explode and/or cause accidents.
- Battery life may vary depending on conditions, environmental factors, functions of the product in use, and devices used with it.

## PRODUCT WARRANTY AND DISCLAIMER

### Limited Warranty

#### Limited Warranty

Klim guarantees the product quality based on the technical specification stated in the product manual, and data regarding product warranty. Here, product warranty extends to the product only. Klim will not be liable for any loss, damage of human life, or loss of property which may result from using the product beyond defective parts or flaws that occur due to problems in manufacture.

#### Warranty Period

Klim guarantees free-of-charge replacements of defective parts of the product or flaws that may have occurred due to problems in manufacture for a period of 2 years from the date of initial purchase.

#### Termination

Quality warranty of the product becomes effective on the date of initial purchase. In addition, the quality warranty of the product expires when the warranty period expires. However, in the following cases, the warranty will be terminated prematurely.

- In the event the product has been sold or transferred to a third party.
- In the event the manufacturer's name, serial number, product label, or other markings have been modified or removed.

- In the event any unauthorized person has tried to disassemble, repair, or modify the product.

**Notice and Waiver**

By buying and using this product, you relinquish considerable legal rights including any claim for compensation for damages. Therefore, be certain to read and understand the following terms and conditions before using the product. Use of this product will constitute consent to this agreement, and forfeiture of rights to all claims. If you do not consent to all the terms and conditions of this agreement, return the product for a refund.

1. You agree that you, your descendants, legal proxies, successors, or transferees will not raise permanent volitional request for any suit, claim, implementation, redemption or similar action from Klim and Sena Technologies, Inc ("Sena") with regard to any occasion such as difficulty, pain, suffering, inconvenience, loss, injury, or death which may occur to you or a third party during the use of this product.
2. You must completely understand and accept all risks (including those occurring due to any careless behavior of yours or others) which may occur during the use of this product.
3. You are responsible for ensuring that your medical condition permits usage of the product and that you are in sufficient physical condition for using any device which can be used with it.

In addition, you must ensure that the product does not limit your abilities and that you are able to use it safely.

4. You must be an adult who can take responsibilities for using the product.
5. You must read and understand the following warnings and alerts:
  - Klim and Sena together with employees, managers, partners, subsidiaries, representatives, agents, supporting firms and suppliers, sole sellers of Klim and Sena (collectively referred to as "the company") recommend that, before using the product and similar devices of any brands including its derivative models, you collect any relevant information in advance and be entirely prepared in terms of weather, traffic situation, and road conditions.
  - When you use the product while you operating any vehicle or equipment such as motorcycles, scooters, mopeds, ATVs, or quad-bikes (hereinafter called as "transportation means"), you must take complete caution regardless of the location of such operation.
  - Use of the product on the road may cause such risks as fracture, serious disability, or death.
  - Risk factors, which may occur when you use the product, may be due to errors of the manufacturer, its agents, or third parties which are involved in the manufacturing.

- Risk factors, which may occur when you use the product, may be unforeseeable. Therefore, you must take full responsibility for any damage or loss caused by all risk factors which may occur when using the product.
  - When you use the product, use good judgment; never use it under the influence of alcohol.
6. You must read and completely understand all terms and conditions of legal rights and warnings that are involved in using the product. In addition, usage of the product constitutes acceptance of all terms and conditions regarding waiver of rights.

## **Warranty Exclusions**

### **Reasons for Limited Liabilities**

If you do not return the product after purchasing it, you relinquish all rights to liabilities, loss, claims, and claims for reimbursement of expenses (including attorney's fees). Therefore, Klim will not be liable for physical injury, death, or any loss or damage of transportation means, possessions, or assets which belong to you or third parties that may have occurred while you use the product. Further, Klim will not be liable for any substantial damage not related to the condition, environment, or malfunction of the product. All risks related with the operation of the product depend entirely on the user regardless of its use by the initial purchaser of a third party.

Use of this product may violate local or national laws. In addition, be aware once again that correct and safe use of the product is entirely your responsibility.

### **Limitation of Liability**

TO THE FULL EXTENT ALLOWED BY LAW, KLIM EXCLUDES FOR ITSELF AND ITS SUPPLIERS ANY LIABILITY, WHETHER BASED IN CONTRACT OR TORT (INCLUDING NEGLIGENCE), FOR INCIDENTAL, CONSEQUENTIAL, INDIRECT, SPECIAL, OR PUNITIVE DAMAGES OF ANY KIND, OR FOR LOSS OF REVENUE OR PROFITS, LOSS OF BUSINESS, LOSS OF INFORMATION OR DATA, OR OTHER FINANCIAL LOSS ARISING OUT OF OR IN CONNECTION WITH THE SALE, INSTALLATION, MAINTENANCE, USE, PERFORMANCE, FAILURE, OR INTERRUPTION OF ITS PRODUCTS, EVEN IF KLIM OR ITS AUTHORIZED RESELLER HAS BEEN ADVISED OF THE POSSIBILITY OF SUCH DAMAGES, AND LIMITS ITS LIABILITY TO REPAIR, REPLACEMENT, OR REFUND OF THE PURCHASE PRICE PAID, AT KLIM'S OPTION. THIS DISCLAIMER OF LIABILITY FOR DAMAGES WILL NOT BE AFFECTED IF ANY REMEDY PROVIDED HEREIN SHALL FAIL OF ITS ESSENTIAL PURPOSE. IN ANY CASE, THE TOTAL COMPENSATION LIABILITIES OF KLIM OR ITS SALES AGENTS SHALL NOT EXCEED THE PRICE PAID FOR THE PRODUCT BY THE PURCHASER.

### **Liabilities Disclaimer**

In addition to damages which may occur due to the use of the product, Klim will not be liable for damages of the product which occur due to the following events.

- In the event the product is misused or used for purposes other than its intended purposes.
- In the event the product is damaged because the user does not follow the content of the product manual.
- In the event the product is damaged because it has been left unattended or has undergone any other accident.
- In the event the product is damaged because the user has used any parts or software which are not provided by the manufacturer.
- In the event the product is damaged because the user has disassembled, repaired, or modified it in such way as is not explained in the product manual.
- In the event the product is damaged by a third party.
- In the event the product is damaged due to Acts of God (including fire, flood, earthquake, storm, hurricane or other natural disaster).
- In the event the surface of the product is damaged by use.



## **Warranty Service**

To obtain product warranty service, send the defective product, at your expense, to the manufacturer or the seller along with proof of purchase (a receipt that shows the purchase date, a product registration certificate of the Website, and other relevant information). Take necessary measures to protect the product. In order to get a refund or replacement, you must include the whole package as it was purchased.

## **Free-of-charge Service**

Klim will provide free-of-charge repair or replacement service for the product when product defects occur within the scope of the product warranty during the warranty period.

