



RESPECT THE ELEMENTS

Race Watch_w013

Instruction Manual

**This watch comes with a 2 year warranty.
For warranty issues please contact your nearest stockist.
Proof of purchase required.**

1.0 Introduction

Thank you for purchasing this watch.

The watch includes real time, daily alarm and a regatta timer which times the starting of a race.

Your watch is carefully designed and produced for regatta use. In order to utilise these features of your watch, it is advisable to read the following notes before using for the first time.

- Avoid exposing the watch to extreme conditions over extended periods.
- Avoid rough use and severe impacts.
- Only a certified watch repairer should open the watch case.
- Occasionally clean your watch with a soft moistened cloth to help maintain its lifespan.
- Store your watch in a dry place when not in use for extended periods.

2.0 Buttons Operation Summary

Mode Button [M]

- In function modes: Press to enter the next mode
- In any setting display: Press to choose among different settings

ST./LAP/SYNC. Button [S/L/S]

- In Daily Alarm Mode: Hold to test alarm sound.
- In Timer Mode : Press to start or synchronise.
- In setting displays: Press to increase the value or hold to increase faster.

STP./RESET Button [S/R]

- In Daily Alarm Mode: Press to select the Alarm Time ON/OFF.
- In Timer Mode: Press to stop or hold to reset the timer.
- In setting displays: Press to decrease the settings or hold to decrease faster.

Set Button [S]

- Press and hold for about 2 seconds to enter the setting displays.
- In setting displays, press to exit and return to the function mode.

Backlight Button [L]

- In any mode/display, press to turn ON the EL backlight for about 3 seconds.

Note: The button operations are summarised as above, for detailed operating instructions, please continue reading.



3.0 Major Function Modes

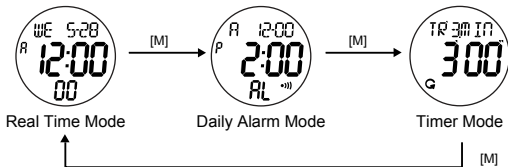

4.0 Real Time Mode

How to set the Real time

- To set the Real time, date and other settings press and hold the [S] button for about 2 seconds in Real Time Mode. (The second digit will start flashing.)

The Setting Sequence

- When the second digit starts flashing, press the [M] button to move the flashing digits following the setting sequence of the diagram in next page or press the [S/L/S] or [S/R] buttons to reset the second digits to zero.
- When the Minute, Hour, Year, Month, Day or LCD level are flashing, press the [S/L/S] or [S/R] buttons to adjust the value.
- When the Format is flashing, press the [S/L/S] or [S/R] buttons to select the 12/24 Hr format or Date format.
- When the Chime/Keytone ON/OFF options are flashing, press the [S/L/S] or [S/R] buttons to toggle it ON/OFF.
- When the setting is completed, press the [S] button once to exit the setting sequence. The setting display will return to Real Time Mode automatically if there is NO key-stroke for about 1 minute.



4.1 Real Time Mode - Setting Sequence

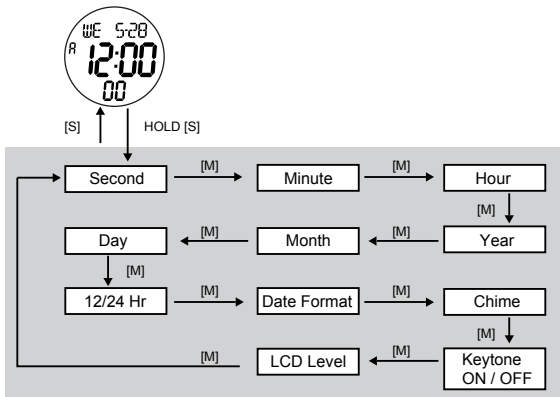



5.0 Daily Alarm Mode

Daily Alarm Mode

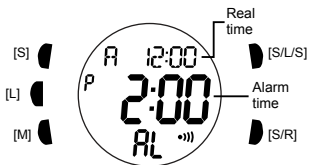
- In the Real Time Mode, press the [M] button to enter Daily Alarm Mode
- The alarm time (hour, minute) is shown on the middle row of the display.
- The real time (hour, minute) is shown on the upper row of the display.
- The alarm will sound at the alarm time every day when the alarm is ON.



To select the Alarm and Chime ON/OFF

- In the Real Time Mode, press and hold the [S] button for about 2s can enter to the time setting, then press the [M] button to scroll through the setting items. When the Chime option appears, press the [S/L/S] or [S/R] buttons to toggle the Chime ON/OFF.
- When the chime indicator  appears, the chime is ON. The watch will beep once every hour.
- In Alarm Mode, press the [S/R] button to set the alarm ON/OFF.
- When the alarm indicator  appears, the alarm is ON. The watch will beep for about 30s at the alarm time.
- The alarm sound can be stopped prematurely by pressing any key.

To test the Alarm sound

- Press and hold the [S/L/S] button to test the alarm sound.

6.0 Timer Mode

How to set the Timer

- In Timer Mode, press and hold [S] button for 2s, the hour digit will be flashing, press the [S/L/S] or [S/R] buttons to adjust the time you want. Press the [M] button to scroll through the setting items.
- When the Minute, Second digits are flashing, press the [S/L/S] or [S/R] buttons to adjust the time.
- In SYNC setting, press the [S/L/S] or [S/R] buttons can select between the SYNC Round and SYNC Down. Please refer to Chapter 6.1 for more details.
- When the Alert option is flashing, press the [S/L/S] or [S/R] buttons to toggle it ON/OFF. Please refer to Chapter 6.1 for more details.

Key Lock Function (suspend buttons operation during counting)

- Press and hold the [L] button to toggle the key lock function ON/OFF, when key lock function is ON,  will appear on the top of the display. The operation of the [S/L/S] and [S/R] buttons will be suspended in order to prevent key pressing by mistake.

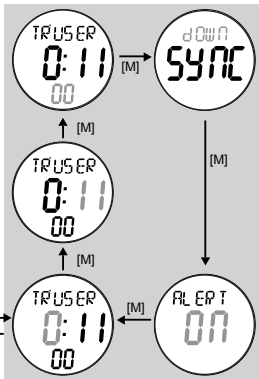
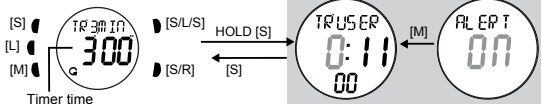

6.1 Timer Mode - Countdown Timer

Countdown Timer (Four Pre-set Values & One User-defined Value)

- This watch's timer has four pre-set values: 5.4.1.0, 5.Min, 3.Min and 1.Min, and one user defined value. Press the [S/R] button to change the display among them.

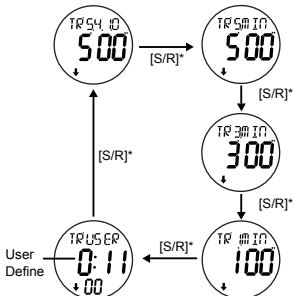

*Remark: Timer is stopped

Multiples of the Pre-set Value

- After you have chosen one of the pre-set values, you can multiply those values by pressing the [S] button.

For example: If the pre-set value is 3-Min, press the [S] button once to double it to 6 minutes; press the [S] button twice to triple it to 9 minutes... and so on.

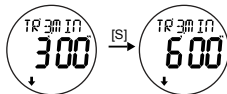

Press the [S/L/S] button to start the timer, the countdown icon ↓ will start flashing.



6.1 Timer Mode - Countdown Timer

Synchronization Function

- When the Countdown Timer is running, press the [S/L/R] button to round off the counting time.
- If the timer is in a "SYNC Down" status, the timer will round down to the next full minute.
- If the timer is in a "SYNC Round" status, the timer will round down or up to the closest minute.

Repeat Function

- In Timer Mode, press and hold the [M] button for about 2s to toggle the repeat function ON/OFF.
- When the Repeat icon  appears, the timer will repeat counting the pre-set values.

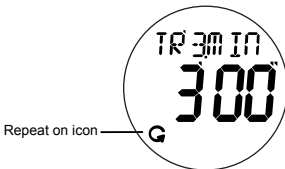

Alert Indications

- The watch will beep once at each minute.
- The watch will beep once at 50, 40, 30 & 20 seconds for the last minute of countdown, and it will beep once at each second for the last 10 seconds
- Long beep for 3 seconds when it reaches zero.
- The watch will keep silence when the Alert option has been set to OFF.
- For 5.4.1.0 sequence, two beeps will be heard at minutes 4 and 1.

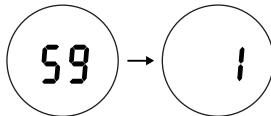

Countdown display from the last 59 seconds to 1 second.

6.2 Timer Mode - Countup Timer & Timer Recall

Countup Timer

- When the Countdown Timer reaches zero, the \downarrow icon will change to a \uparrow icon and enter to the Countup Timer.
- When the Countup Timer is running, press the [S/R] button to stop the countup and press the [S/L/S] button to resume it. The Countup Timer can count to a maximum of 99 hours 59 minutes 59 seconds.
- When the Countup Timer is running, press the [S/L/S] button to take a Lap time. It can store up to 20 Laps.
- When the countup is stopped, hold the [S/R] button to reset the timer and return to the countdown display.

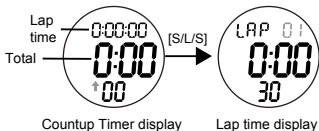

Timer Recall

- In the Countup Timer, press the [S] button once to enter Timer Recall display.
- In Timer Recall display, press the [S/L/S] or [S/R] buttons to recall the lap time and total time.
- Press [S] button once to return to Timer Mode.

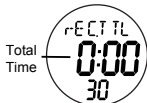

7.0 Power Saving Mode

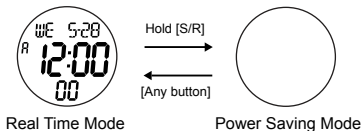

Power Saving Mode

- This watch includes a Power saving function. (this function allows the battery to last longer)
- While in the Power Saving Mode, the watch function is still working normally. (i.e. The time keeping function is still running during Power Saving Mode)

How to enter/exit Power Saving Mode

- Hold down the [S/R] button in Real Time Mode for about 5 seconds, then the LCD display will be turned off.
- Press any key to exit the Power Saving Mode, and the LCD display will be resumed.

8.0 Specifications

Real Time Mode

- Hour, minute, second, am, pm, month, day, and day of week
- 12-hour or 24-hour format
- Auto-Calendar pre-programmed from the year 2000 to 2099
- day/Month or Month/day format

Timer Mode

- Countdown Timer pre-set time selection: 5.4.1.0 min, 5-min,3-min,1-min & user defined
- Time Synchronization
- Repeat countdown function
- Multiply pre-set timer
- Key lock function
- 20 laps recall for Countup Timer
- Countup range: Max. 99 hours 59 minutes 59 seconds

Daily Alarm Mode

- 1 daily alarm
- Hourly chime

Alarm Sounds

- Sounds for 30 seconds at alarm time

Others

- Electro-Luminescent (EL) backlight
- Battery: Single 3V lithium battery (CR2032)

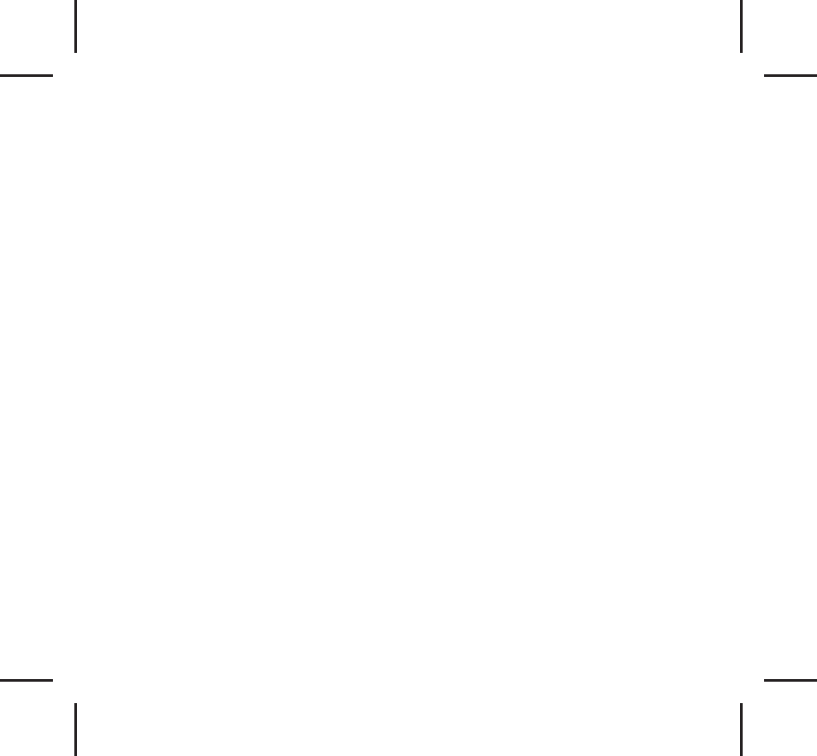

gillmarine.com