

# FERVE PRIMA

F-811  
F-812  
F-915  
F-918







CE



# FERVE PRIMA



			<b>A</b> arith.	<b>A</b> eff.		
<b>F-811</b>	230 V / 177 W 50/60 Hz	12 V	6 - 12 A	8.5 - 17 A	35 - 140 Ah	6.320 g
<b>F-812</b>	230 V / 315 W 50/60 Hz	12 - 24 V	6-12 A	8.5 - 17 A	35 - 140 Ah	8.620 g
<b>F-915</b>	230 V / 395 W 50/60 Hz	12 - 24 V	8-16 A	11 - 22.5 A	50 - 180 Ah	9.400 g
<b>F-918</b>	230 V / 540 W 50/60 Hz	12 - 24 V	10-20 A	14 - 28 A	80 - 225 Ah	11.670 g





EU/UE

**DECLARACIÓN DE CONFORMIDAD  
DECLARATION OF CONFORMITY  
DÉCLARATION DE CONFORMITÉ  
KONFORMITÄTSEKLRÄRUNG  
CONFORMITEITSVERKLARING**

Nosotros, We, Nous, Wir, Wij

FERVE, S.A.

declaramos, bajo nuestra única responsabilidad, que el producto  
*declare, under our sole responsibility, that the product*  
*déclarons, sur notre seule responsabilité, que le produit*  
*erklären, in alleiniger Verantwortung, daß das Produkt*  
*verklaren, onder onze eigen verantwoordelijkheid, dat de producten*

**Cargadores de baterías / Battery chargers / Chargeurs de batteries / Batterieladegeräte / Acculaders**

**F-811, F-812, F-915, F-918**

al cual esta declaración se refiere, es conforme a la siguiente norma:  
*to which this declaration relates, is in conformity with the following standard:*  
*auquel se réfère cette déclaration, est conforme à la norme :*  
*auf das sich diese Erklärung bezieht, mit der folgenden Norm:*  
*waar deze verklaring zich op richt, in overeenstemming is met de volgende standaard:*

**EN 60335 - 1: 2012/A11: 2014**

**EN 60335 - 2 - 29: 2006/A2: 2010**

según las disposiciones de la Directiva:  
*following the provisions of Directive:*  
*conformement aux dispositions de Directive :*  
*Gemäß den Bestimmungen der Richtlinie:*  
*volgens de richtlijn:*

**2014/35/EU**

El Vendrell, 2022



- Lea el manual de instrucciones antes de usar el cargador.
- Read the instruction manual before using the charger.
- Veuillez lire le manuel d'instructions avant d'utiliser le chargeur.
- Bitte lesen Sie diese Gebrauchsanleitung vor der Benutzung des Ladegeräts sorgfältig durch.
- Lees de gebruiksaanwijzing alvorens U de lader gaat gebruiken.



- Evite las llamas y chispas.
- Avoid flames and sparks.
- Éviter flammes et étincelles.
- Offene Flammen und Funken.
- Vermijdt vuur en vonken.



- ¡Atención! Gas explosivo.
- Attention! Explosive gas.
- Attention! Gaz explosif.
- Achtung! Explosionsgefahr durch Gas.
- Let op! Knalgas.

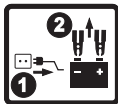

- Desconecte el cable de red (1) antes de conectar o desconectar las pinzas (2).
- Disconnect the mains cable (1) before connecting or disconnecting the clamps (2).
- Débranchez le câble du secteur (1) avant de brancher ou de débrancher les pinces (2).
- Ziehen Sie bitte den Netzkabel (1), bevor Sie die Zangen anschließen oder abklemmen (2).
- Maak de kabel los van het net (1) alvorens de klemmen te koppelen of te ontkoppelen (2).

## D VORSICHTSMASSNAHMEN



- Utilícelo en un lugar ventilado.
- Use it in a well-ventilated place.
- Utilisez-le dans un lieu aéré.
- Benutzen Sie das Gerät in einem belüfteten Raum.
- Gebruik het apparaat in een geventileerde ruimte.



- El cable de red sólo puede ser sustituido en un taller especializado.
- The wire to the mains can only be replaced at a specialized workshop.
- Le câble d'alimentation au secteur ne peut être remplacé que dans un atelier spécialisé.
- Das Stromkabel darf nur in einer spezialisierten Werkstatt ausgewechselt werden.
- Voedingsspanningskabels mogen alleen door geautoriseerde dealers worden vervangen.

## NL WAARSCHUWINGEN



- No exponga el aparato a la lluvia.
- Do not expose the equipment to rain.
- N'exposez pas l'appareil à la pluie.
- Setzen Sie das Gerät nicht dem Regen Aus.
- Zet het apparaat niet in de regen.



# FERVE



**E**

**CARGADORES DE BATERÍAS**

*MANUAL DE USO Y SEGURIDAD*

**GB**

**BATTERY CHARGERS**

*OPERATING INSTRUCTIONS AND SAFETY MANUAL*

**F**

**CHARGEURS DE BATTERIES**

*MANUEL D'UTILISATION ET DE SÉCURITÉ*

**D**

**BATTERIELADEGERÄTE**

*BETRIEBS- UND SICHERHEITSHANDBUCH*

**NL**

**ACCULADERS**

*GEBRUIKSAANWIJZING EN VEILIGHEIDSVORSCHRIFTEN*



**F-811**



**F-812**



**F-915**



**F-918**

**E**

COMPROBACIÓN DEL ESTADO DE CARGA DE LA BATERÍA

**GB**

TESTING THE BATTERY CONDITION

**F**

VÉRIFICATION DE L'ÉTAT DE CHARGE DE LA BATTERIE

**D**

ÜBERPRÜFUNG DES LADEZUSTANDS DER BATTERIE

**NL**

HET TESTEN VAN DE ACCU CONDITIE

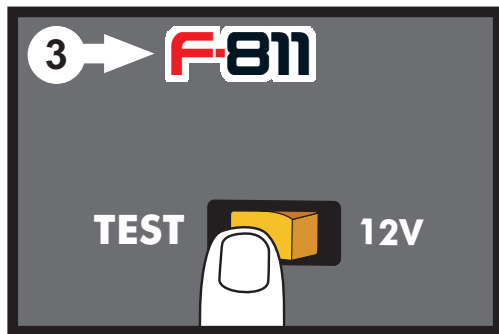
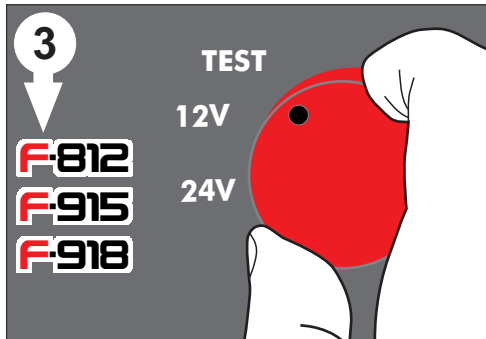
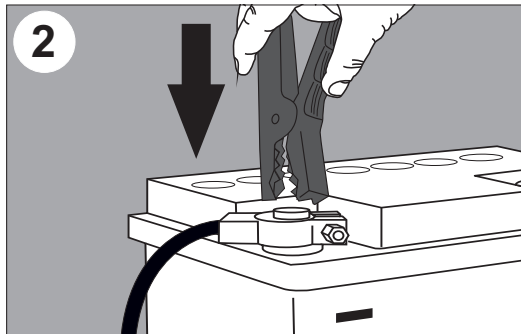
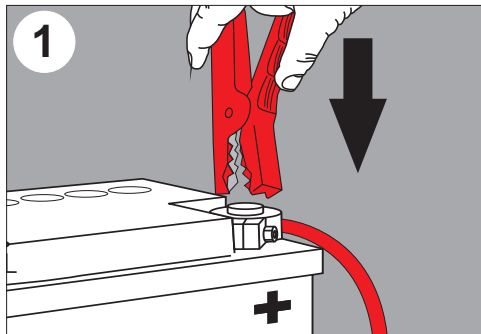



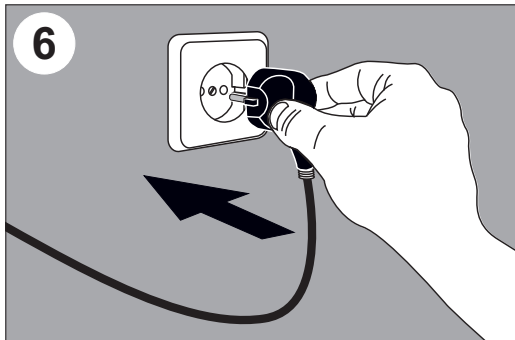
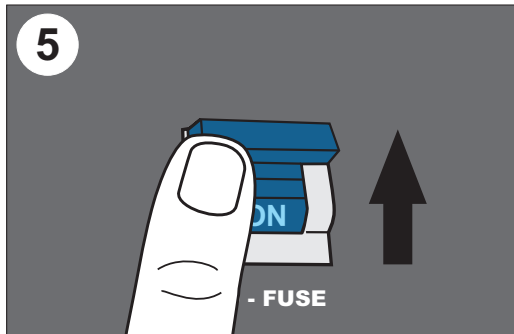
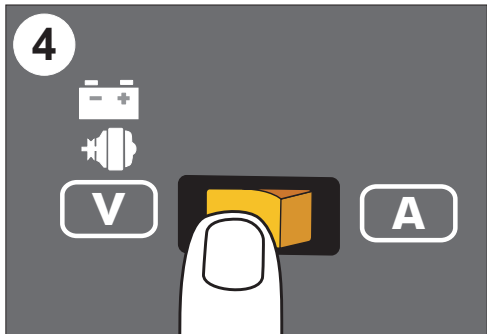









8



 12 V	 24 V	 %
< 11.9	< 23.8	 < 20%
12.1	24.3	 25%
12.3	24.6	 50%
12.5	25	 75%
12.7	25.4	 100%

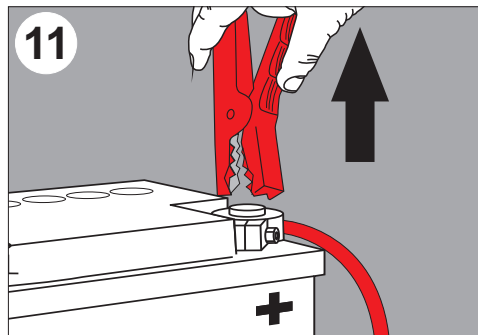
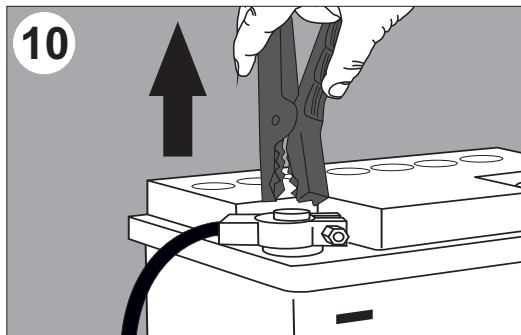
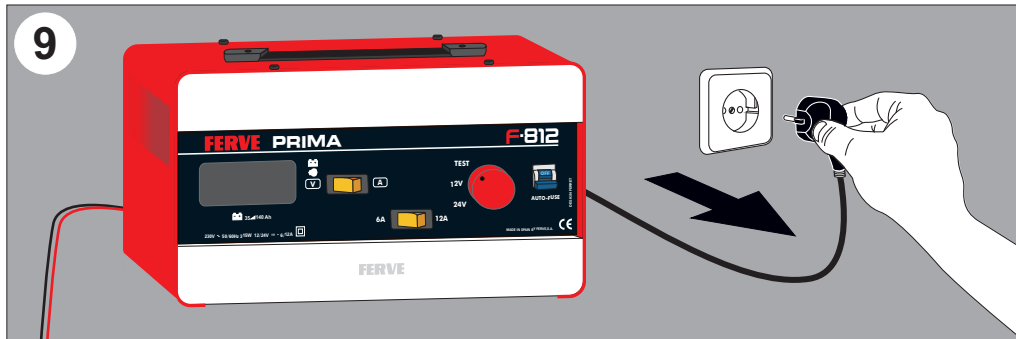

**E** PROCESO DE CARGA DE LA BATERÍA

**GB** BATTERY CHARGING PROCESS

**F** PROCESSUS DE CHARGE DE LA BATTERIE

**D** LADEPROZESS DER BATTERIE

**NL** LAADPROCES VAN DE ACCU

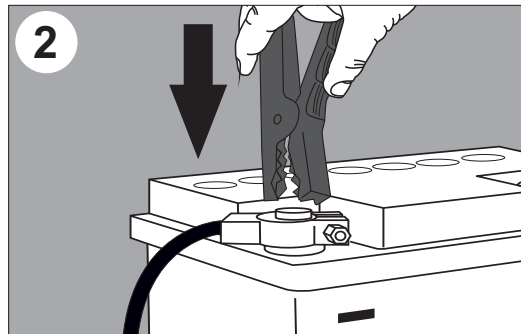
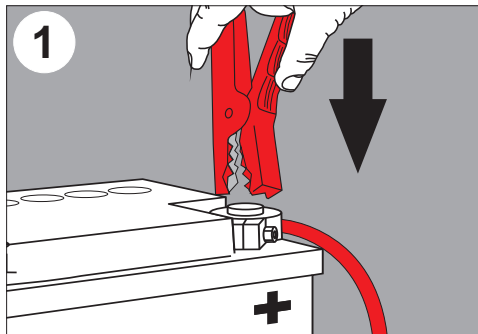

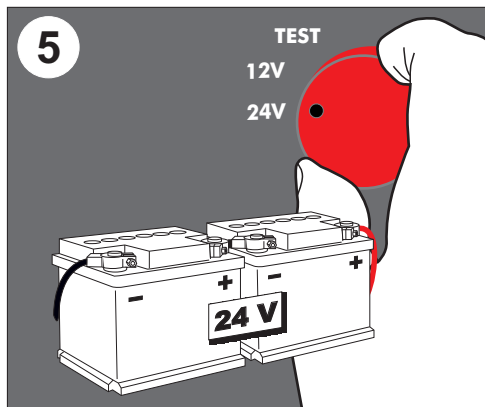
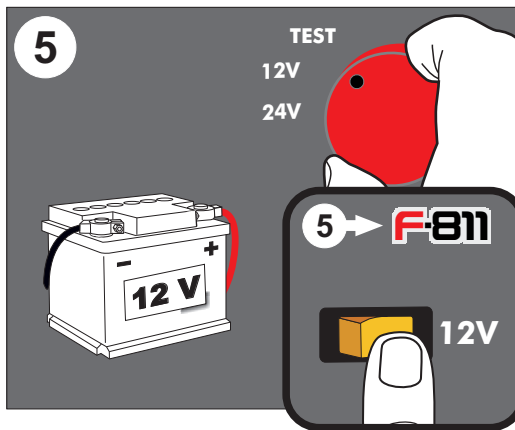
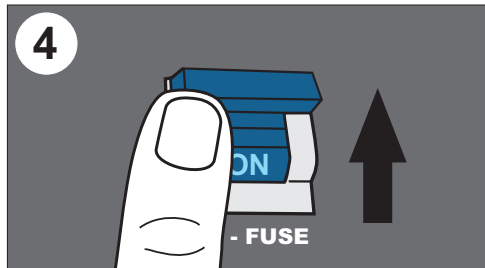
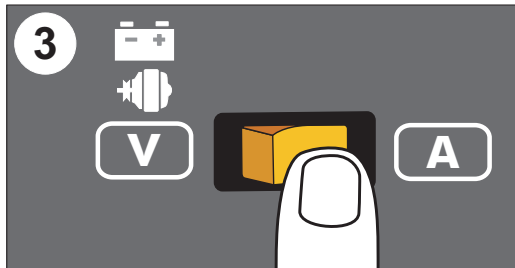

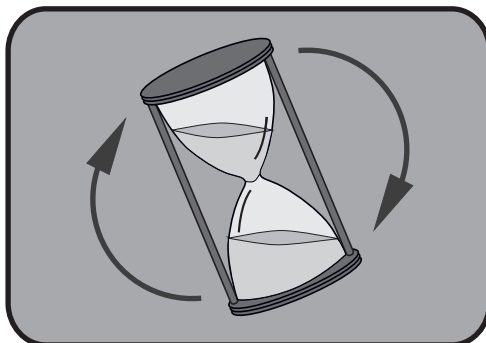
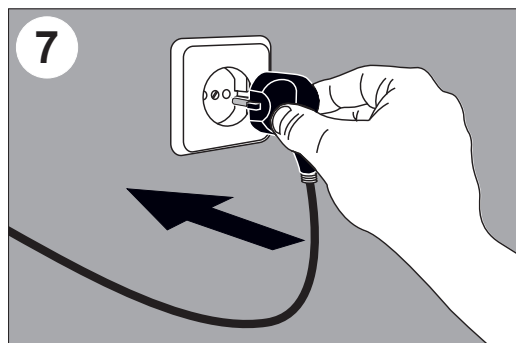
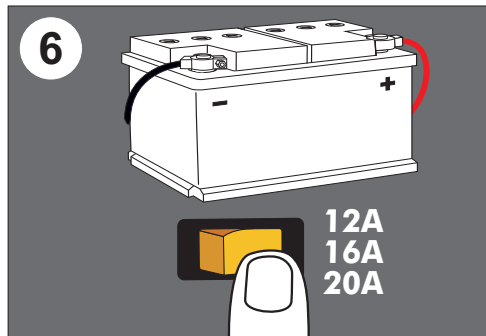
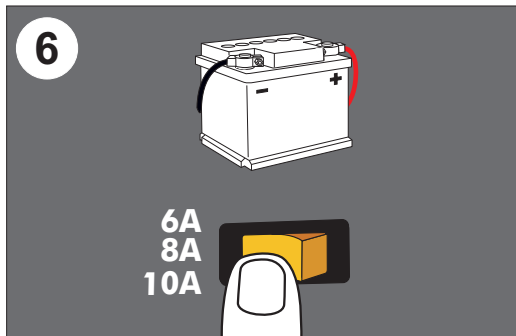

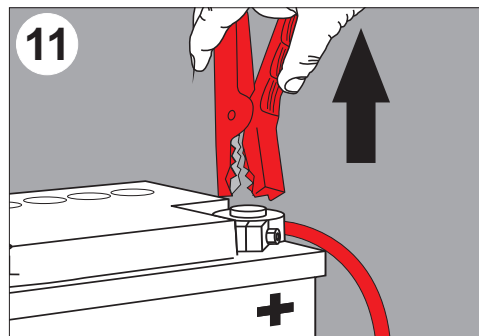
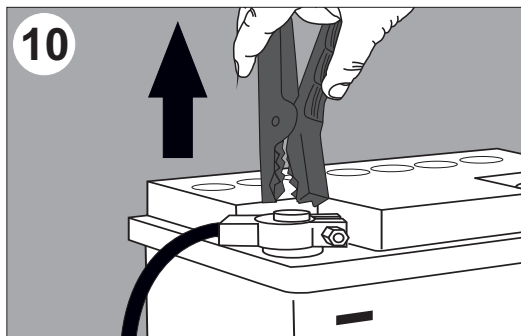
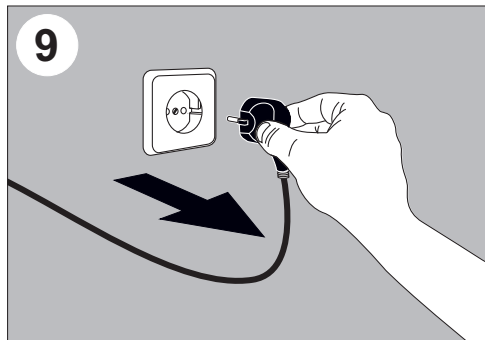
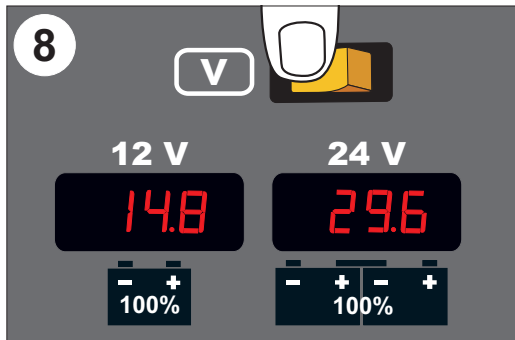

- E** PRUEBA DEL ALTERNADOR
- GB** TESTING THE ALTERNATOR
- F** TEST DE L'ALTERNATEUR
- D** ÜBERPRÜFUNG DES WECHSELSTROMGENERATORS
- NL** CONTROLEREN VAN DE WISSELSTROOMDYNAMO

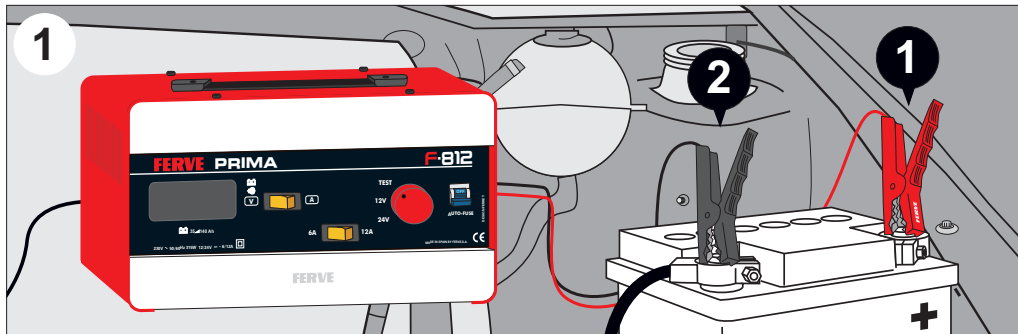



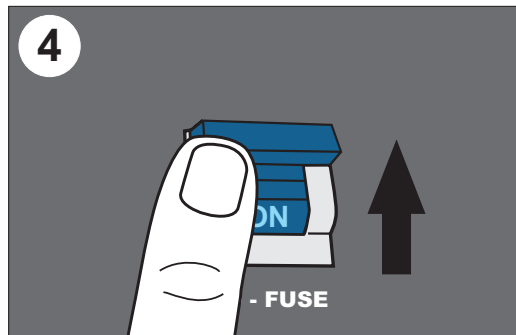
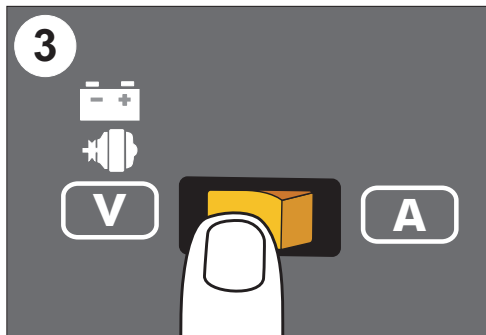
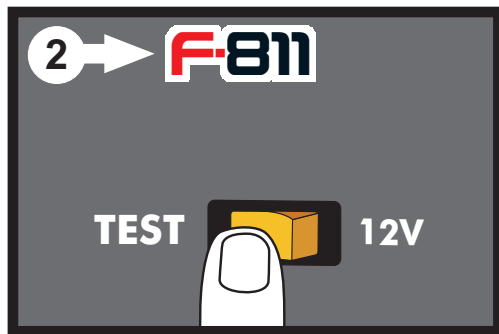
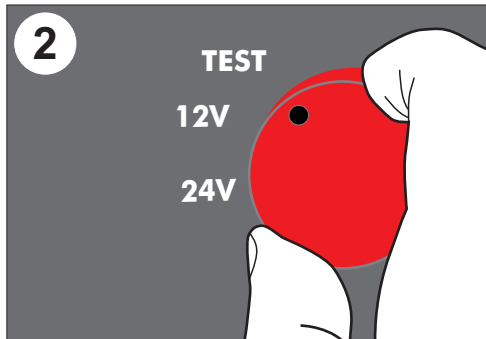

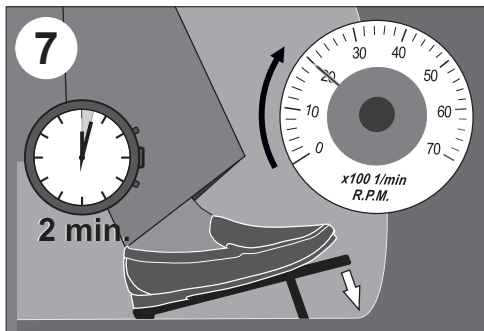
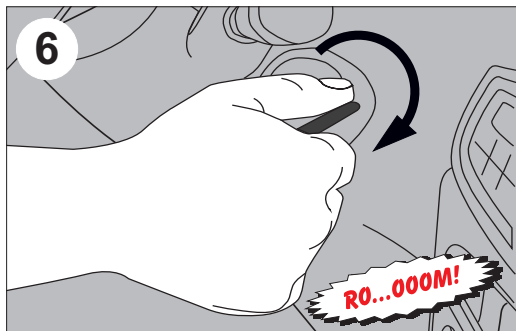
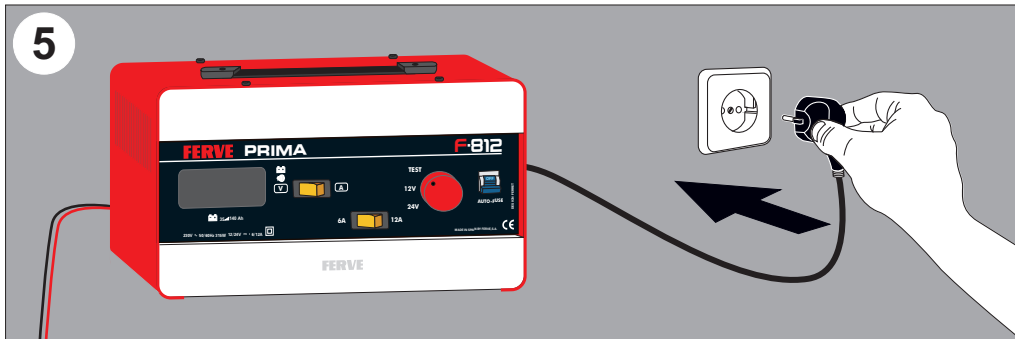

8

12 V

24 V

13.8

27.6



9

 12 V

 24 V

 ?

< 13.3

< 26.3

 BAJO LOW BAS NIEDRIG ZWAK

13.3 - 14.8

26.3 - 29.6

 OK

> 14.8

> 29.6

 ALTO HIGH HAUT HOCH HOOG

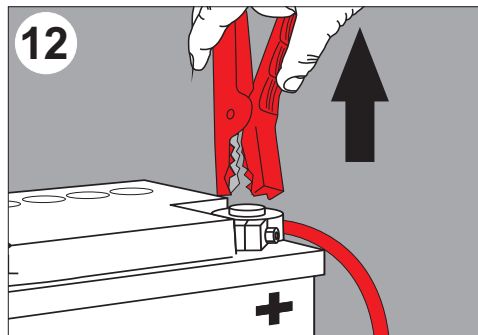
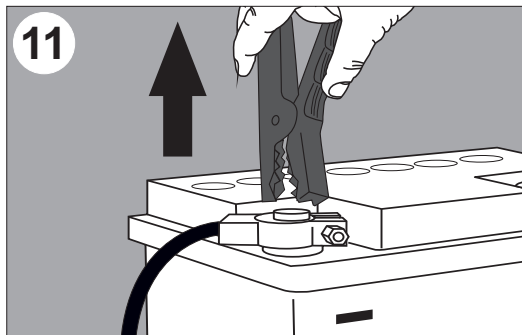
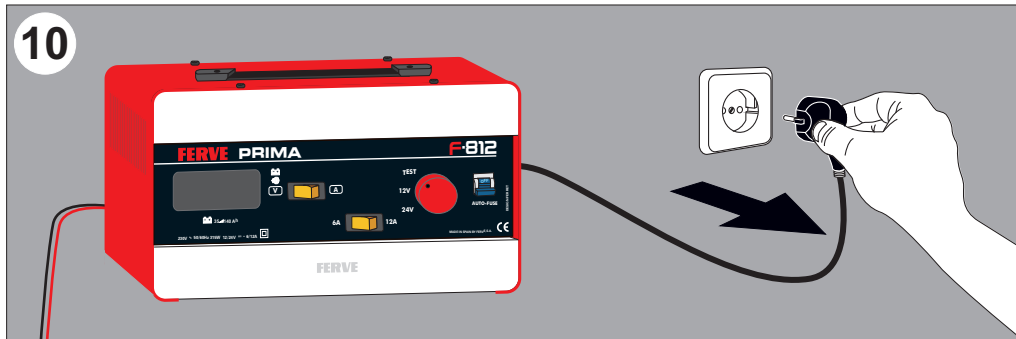

## **E** GARANTÍA

FERVE garantiza este aparato contra todo defecto de fabricación o de las piezas durante un período de 36 meses a partir de la fecha de compra. Quedan excluidos los daños provocados por errores de manejo, suciedad, conexión o energía inadecuada, accidentes y en general aquellos que provengan de causas externas al aparato. Cualquier otra prestación comprometida por el distribuidor será de la exclusiva responsabilidad del mismo. El presente documento tampoco cubre los deterioros ocasionados a otros bienes como consecuencia de un defecto del aparato garantizado. Esta garantía solamente tendrá validez acompañada de la factura de compra original o el recibo del establecimiento. Esta garantía perderá su vigencia cuando el aparato sea manipulado por personal o talleres ajenos a nuestros servicios técnicos.

## **GB** WARRANTY

FERVE warrants this device against all-defective or faulty manufacturing or parts for a period of 36 months as of the purchase date. This warranty excludes damages caused by mishandling, dirt and filth, improper connection or power, accidents and, in general, any damages arising from causes that are external to the device. Any other warranty performance agreed to by the distributor shall be the exclusive liability of this party. Furthermore, this document does not cover wear or damage caused to other goods or assets as a result of a fault in the device under warranty. This warranty is only valid when accompanied by the original invoice or sales receipt. This warranty shall lose validity if the device is handled by personnel or shops not related to our technical service.

## **F** GARANTIE

FERVE garantit cet appareil contre tout défaut de fabrication ou des pièces pendant une période de 36 mois à compter de la date d'achat. Sont exclus les dommages provoqués par des erreurs de manipulation, de la saleté, un branchement ou une source d'énergie incorrects, des accidents et, en règle générale, tous les dommages provoqués par des causes ne concernant pas l'appareil. Toute autre prestation de garantie engagée par le distributeur sera sous sa seule responsabilité. Ce document ne couvre pas non plus les détériorations occasionnées à d'autres biens suite à un défaut de l'appareil sous garantie. Cette garantie est valable seulement avec la présentation de la facture original ou le reçu de vente. Cette garantie perdra sa validité si l'appareil est manipulé par du personnel ou des ateliers n'appartenant pas à nos services techniques.

## **D** GARANTIE

FERVE gewährt eine Garantie auf dieses Gerät, welche jeglichen Herstellungsfehler bzw. Fehler an den Teilen über einen Zeitraum von 36 Monaten ab Kaufdatum abdeckt. Zudem sind von der Garantie Beschädigungen aufgrund von Handhabungsfehlern, Verschmutzung, unsachgemäßem Anschluß bzw. ungeeigneter Energiezufuhr, Unfälle und im allgemeinen jene Beschädigungen und Unfälle, die aufgrund von geräteexternen Ursachen hervorgerufen wurden, ausgeschlossen. Jede weitere Garantieleistung, zu der sich der Verkäufer verpflichtet, fällt ausschließlich in dessen Verantwortungsbereich. Dieses Dokument deckt ebensowenig die Schäden an anderen Gütern ab, die sich infolge eines Fehlers des durch die Garantie abgedeckten Gerätes ergeben könnten. Diese Garantie ist nur gültig, wenn sie von der ursprünglichen Rechnung begleitet wird, oder Verkäufe quittieren. Diese Garantie verliert ihre Gültigkeit, wenn am Gerät Eingriffe durch Personal Oder Werkstätten, die nicht unserem technischen Service angehören, vorgenommen wurden.

## **NL** GARANTIE

FERVE garandeert dat dit apparaat vrij is van defecten, in onderdelen of constructie, gedurende 36 maanden na datum van aankoop. Uitgesloten van de garantie is de schade die het gevolg is van een verkeerde bediening, vuil, niet geschikte aansluiting of voedingsbron, ongevallen en in het algemeen alle schade die door externe oorzaken aan het apparaat veroorzaakt is. Elke andere garantiebepaling die met de distributeur overeengekomen is, valt geheel en uitsluitend onder de verantwoordelijkheid van de distributeur. De garantie dekt geen schade aan andere goederen die het gevolg zijn van een defect van het apparaat, voorwerp van de garantie. Zulks waarborg zit uitsluitend vigerend wanneer vergezeld tegen naar de originele factuur of Omzet stortingsbewijs. Deze garantie verliest haar geldigheid wanneer het apparaat door personeel of werkplaatsen behandeld wordt die niet door ons erkend zijn.





# FERVE

© FERVE, S.A. - Made in Spain

FERVE, S.A

Ctra. de Calafell, 15-25 - Apartado (P.O. Box) 7  
43700 El Vendrell (España)

Tel. +34 977 660 500 - Fax +34 977 661 160

[www.ferve.com](http://www.ferve.com)  
2093002-0122