

# CONTENTS

<u>Contents</u>	<u>1</u>
<u>Your 20/20 CD display</u>	<u>2</u>
<u>Installation</u>	<u>3</u>
<u>Mounting the 20/20 CD</u>	<u>3</u>
<u>Mast mounting</u>	<u>3</u>
<u>Bulkhead mounting</u>	<u>5</u>
<u>Adjustable mounting bracket</u>	<u>6</u>
<u>System overview</u>	<u>7</u>
<u>Operation</u>	<u>8</u>
<u>Function selection via a remote button</u>	<u>9</u>
<u>Function selection via the FFD</u>	<u>9</u>
<u>Re-configuring the preset functions</u>	<u>13</u>
<u>20/20 CD backlighting</u>	<u>15</u>
<u>Diagnostics</u>	<u>16</u>
<u>20/20 CD technical specification</u>	<u>18</u>

## Your 20/20 CD display

The 20/20 CD is a fully programmable, single function display incorporating large digits with abbreviated function text. The display is designed for maximum visibility at wide viewing angles at distances up to 60 feet. It is thus ideal for displaying the primary functions (eg. Boat speed, compass heading, wind angle etc.) for viewing by the entire crew at a glance. At night the display is backlit showing red digits on a black background.

The 20/20 CD operates with any Hydra, Hercules 690 and HS 921 systems via a simple network connection. It is fully waterproof and designed for mounting on deck in the cockpit, or at the mast. It may be configured to display any function available on the particular system ( See Operation).

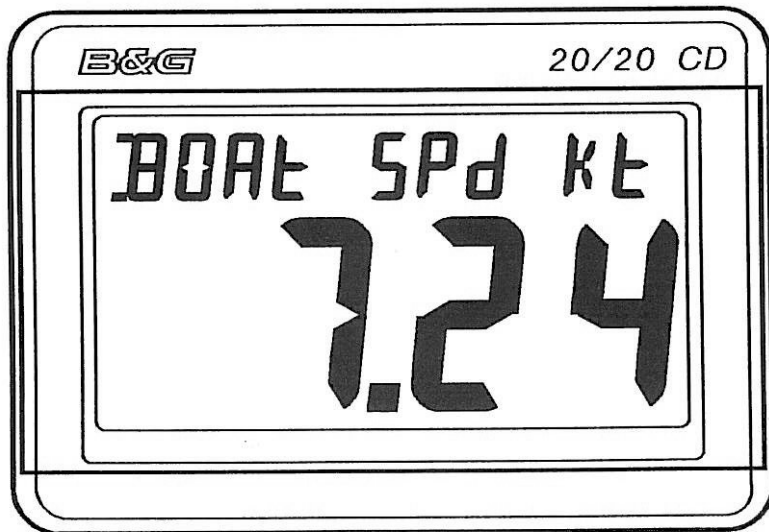

# Installation

## Mounting the 20/20 CD

The physical shape and size of the 20/20 CD is very similar to the standard Full Function Display (FFD), hence its mounting is very flexible. There are three main applications, mast, bulkhead or adjustable bracket.

## Mast mounting

Displays mounted beneath the boom on the mast will enable the helmsman and entire crew to view all critical information at a glance. A pair of lightweight mast brackets can be supplied by B & G for this application.

It is important to ensure that the display does not foul any of the main sail control lines which ideally should pass between the rear of the display and the mast. The diagram below shows a typical mast bracket assembly.

*Note: It is recommended that an insulating paste is used between the mast and the bracket rivets to avoid corrosion.*

## Installation

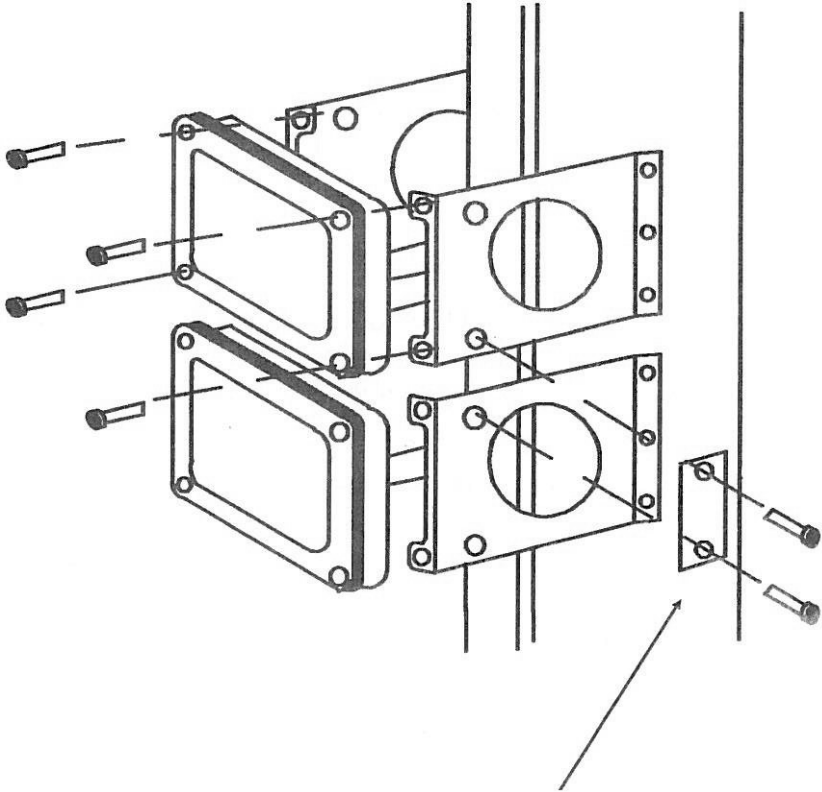

**A connecting plate may be fitted when two or more displays are stacked together as in this example.**

*Mast mounting kit 332-00-006*

## Installation

### Bulkhead mounting

The 20/20 CD may be also mounted through a bulkhead, in the cockpit for example, in a similar way to the standard FFD.

Each unit is supplied with a template for drilling and cutting the bulkhead holes. A self adhesive sealing gasket is also supplied which must be sandwiched between the bulkhead and the display surround to ensure a water tight installation.

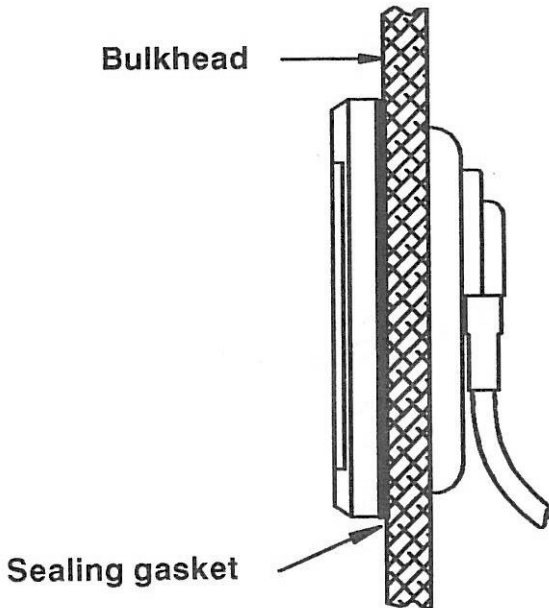

*Bulkhead mounting*

## Installation

### Adjustable mounting bracket.

If required the 20/20 CD can be mounted to stand upright on a horizontal or sloping surface. For example, on a power boat instrument console. This application uses B & G's adjustable mounting kit which enables the display to be angled for optimum viewing.

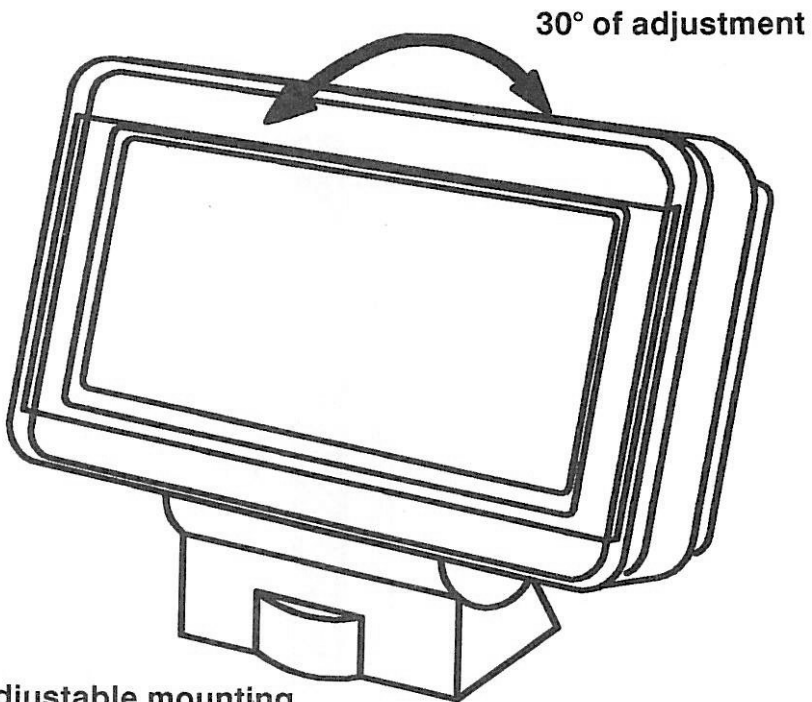

**Adjustable mounting  
bracket 239-00-074**

*Adjustable mounting bracket*

# Installation

## System overview

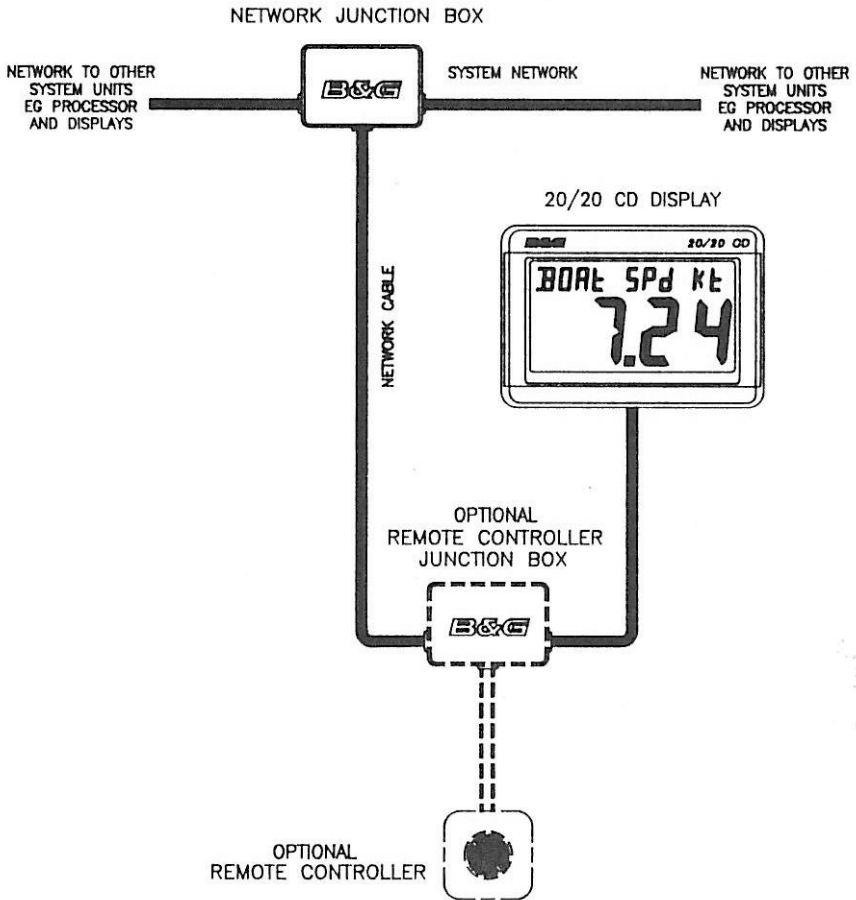

REFER TO INSTALLATION SHEET 332-IS-0381 FOR CONNECTION DETAILS

## Operation

The 20/20 CD can display any function that is available on either the Hydra, Hercules 690 or HS 921 systems together with descriptive text for the particular function. (See relevant handbook for list of functions available.)

There are 14 preset functions which may be easily selected via a remote pushbutton connected directly to the display, or via any FFD on the system. The 14 functions are initially set as follows:

- Boat speed (BOAT SPD KT)
- Depth m (DEPTH M )
- Depth ft (DEPTH FT)
- Apparent wind speed (APP W/S KT)
- Apparent wind angle (APP W/A )
- True wind speed (TRUE W/S KT)
- True wind angle (TRUE W/A )
- True wind direction (TRUE DIR M)
- Velocity made good (VMG KT)
- Compass Heading (HEADING M)
- Timer Count up/down (TIMER MS)
- Bearing to waypoint (BTW RMB M) \*
- Course over ground (CRSE O/G M) \*
- Speed over ground (SPD O/G KT) \*

*\* Note: These functions will appear blank if no position fixer is connected to the system.*



## Operation

### Function selection via remote button

If a remote button is connected directly to a particular 20/20 CD display, (see Installation Sheet 332-IS-0381) any one of the 14 preset functions listed above may be selected by a press and hold of the button. The display will then cycle through the functions. When the desired one is found, release the button. If the button is held for too long and the desired function is missed, release the button, then press and hold again to reverse the direction of cycle.

### Function selection via the FFD

*Note: This facility is only available with FFD software version 3A upwards.*

An alternative to using a dedicated remote button, is to control the 20/20 CD using any one of the standard FFDs on the system. If there are two or more 20/20 CDs fitted then these too can be controlled from the same FFD.





The diagram on page 12 shows how the FFD may be used to control the 20/20 CDs.

## Operation

### Step A



Hold the  key down for at least 2 seconds. The FFD display will change to show the function that is currently displayed on one of the 20/20 CDs. In this example, 20/20 CD no. 1, which consequently flashes to indicate that it may be changed. The bottom section of the FFD indicates the 20/20 CD number (no. 1) and the current option number. For example, option 5 - apparent wind angle.

### Step B

With the 20/20 CD no.1 now flashing, a press and hold of the  key will now cycle the 20/20 CD display through the 14 preset functions, (steps C, D etc.,) similar to the remote button operation in 3.1. The FFD top display will repeat the function shown on the 20/20 CD. If the  key is released and pressed again, the direction of cycle is reversed. When the desired function is found, release the  key. Now press the  key, the FFD will return to normal operation, and the 20/20 CD will stop flashing.

## Operation

### Step B1

If the 20/20 CD requiring change is not the current flashing display, pressing the  key will select the next 20/20CD, in this case, no.0. In fact successive presses of the  key will cycle through all the 20/20 CDs on the system, independent of how many there are. The FFD display will consequently show the current 20/20 CD number and the currently displayed function. When the desired 20/20 CD is reached, pressing the  key, as in Step B through to Step D and so on, will cycle that display through its 14 preset functions.

A final press of the  key will return the FFD back to normal operation as before and the 20/20 CD will stop flashing.

*Note: The FFD will remember which 20/20 CD it was last controlling even if the power is turned off; consequently, a particular FFD can be dedicated to a specific 20/20 CD for convenience.*

# Operation

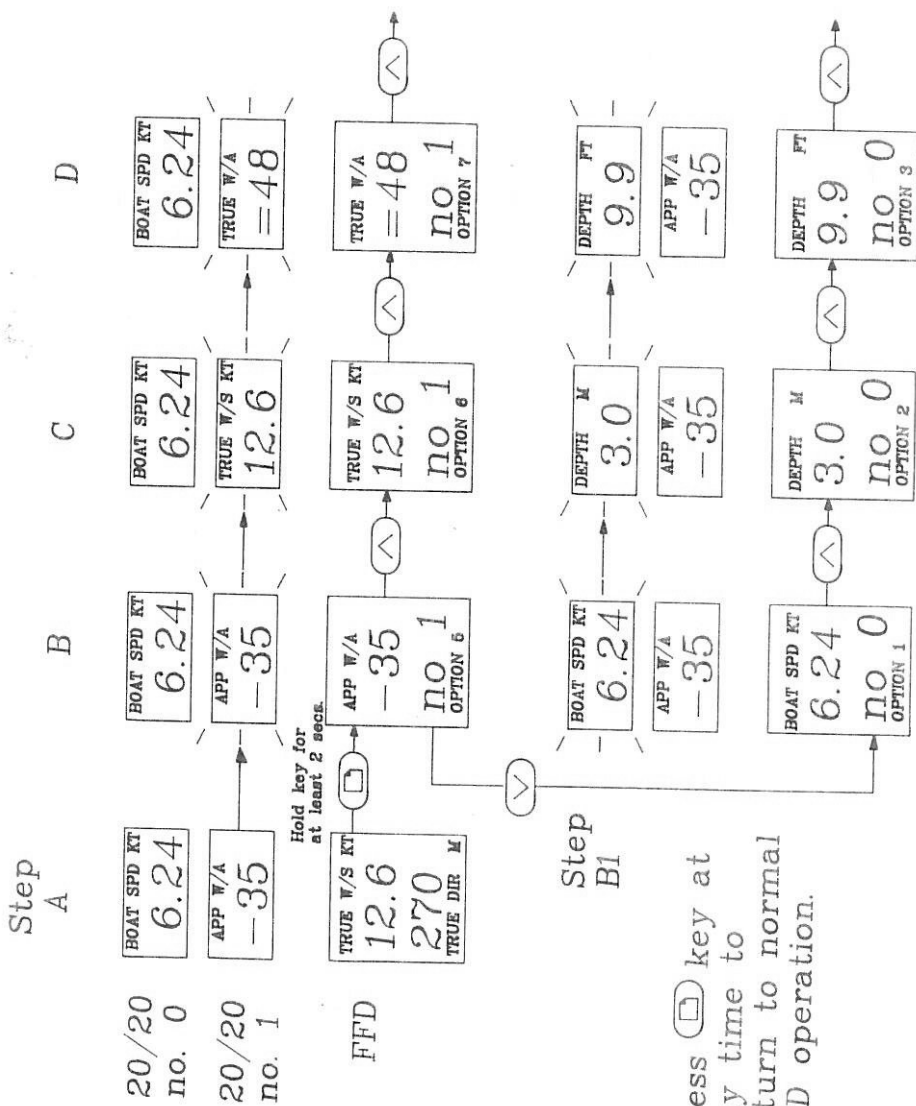

## Operation





### Re-configuring the preset functions

Listed at the beginning of this section are the 14 preset functions that are initially set in the 20/20 CD. Any one of these may be re-configured to show any other function on the system that is not included in the initial list of 14. This facility also allows functions to be displayed from a position fixer for example, or from an external computer interfaced through the Hercules 690 performance unit.

The procedure for re-configuring the 20/20 CD functions is as follows:

- Select the appropriate display by following Steps A & B1 in section 3.2.
- With the 20/20 CD flashing, hold the  key to cycle through the current preset functions until the function that requires changing is found. Example: Change VMG to Target Speed

## Operation

- With VMG flashing on the 20/20 CD, press the  key on the FFD, "SPEED" will appear flashing on the top FFD display. Now hold the  key to cycle through the normal FFD menu until "PERFORM" appears. Press the  key and then hold the  key to step through the **PERFORM** menu until "TARG SPD" appears. Now a final press of  key will fix the new function on the 20/20 CD display in place of the previous one, eg., VMG.

In a similar way, any function from the FFD menu can be configured for 20/20 CD display.

*Note: As previously mentioned, it is possible to configure the 20/20 CD with externally generated functions with associated text. (for eg. from an external computer or from the B & G linear input expansion unit) However, the associated function text will only be stored internally during power off if these functions are configured on any one of the first ten setting options. (signified on the FFD by "OPTION 1 - 10".) This is due to the internal memory capacity of the 20/20 CD.*

## Operation

### 20/20 CD backlighting

For viewing at night or in dark conditions, the 20/20 CD display may be backlit showing red characters and digits on a dark background. The level of illumination is adjustable in three steps from maximum brightness to Off. In general maximum brightness will only be required under twilight conditions, during normal darkness the mid or low levels are more suitable.

The lighting is controlled using the Lights key on any of the FFDs or Halcyon displays on the system.

## Diagnostics

The 20/20 CD contains a number of self test routines which enables the user to fully test the display if there is a suspected fault. To operate the diagnostics facility, it is necessary to connect a remote button across the ground and remote button input wires located in the display junction box. (See Installation Sheet 332-IS-0381)

The diagnostics procedure is as follows:

Apply power to the unit whilst holding the button depressed, the display will show the word "PROM".

### PROM

Release the button to execute the PROM test which checks the permanent memory operation. If the test passes, the software checksum is displayed giving the software version number in the right hand two characters. (eg., 1A, 3A). If the test fails, an appropriate message will be displayed. However, in this case the operation of the unit cannot be assured.

A short press of the button will execute the next test and so on until all tests are complete. These are as follows:

### RAM

This checks for correct operation of the local working memory.



## Diagnostics

### EEPROM

This checks for correct memory retention when power is disconnected from the unit.

### NETWORK

Ideally, for this test to be effective, the network feed to the display should be disconnected at the junction box (See Installation Sheet 332-IS-0381). In addition, a 50 ohm resistor should be connected across the network feed from the display (See Installation Sheet 332-IS-0381). This test checks for correct communication with the network. **PASS** will appear if all is well, else a numerical value will indicate an error condition.

### LIGHTING

Each successive button press will activate the back lighting from maximum level to all off.

### DISPLAY

Holding the button pressed will cycle the display through all individual segments to highlight any missing or shorted segments. If the key is released for longer than 5 seconds, the display exits the diagnostics facility.

## Technical specification

### Size and weight

165mm x 110mm x 43mm, 0.5 Kg  
6 1/2" x 4 1/2" X 1 1/2", 1lb

---

### Temperature range

Operational: -10°C to +60°C  
Storage: -25°C to +80°C

---

### Humidity range

0 - 100%

---

### Power supply

+10V to +16V (+12V DC. nominal)  
Current drain - typically 8.5mA - 10mA max  
(with lighting) 90mA max.

---

### Cable length

5m (16 ft)

---

### Operation

Operates with all Hydra, Hercules 690 & HS 921 systems.  
Fully network compatible.

---