



SL4302K/SL5502K/SL6502K
LCD Monitor
User Manual



Disclaimer

BenQ Corporation makes no representations or warranties, either expressed or implied, with respect to the contents of this document. BenQ Corporation reserves the right to revise this publication and to make changes from time to time in the contents thereof without obligation to notify any person of such revision or changes.

Copyright

Copyright 2020 BenQ Corporation. All rights reserved. No part of this publication may be reproduced, transmitted, transcribed, stored in a retrieval system or translated into any language or computer language, in any form or by any means, electronic, mechanical, magnetic, optical, chemical, manual or otherwise, without the prior written permission of BenQ Corporation.

PANTONE® Colors generated may not match PANTONE-identified standards. Consult current PANTONE Publications for accurate color. PANTONE® and other Pantone trademarks are the property of Pantone LLC. © Pantone LLC, 2020.

Product support

This document aims to provide the most updated and accurate information to customers, and thus all contents may be modified from time to time without prior notice. Please visit the website for the latest version of this document and other product information. Available files vary by model.

1. Make sure your computer is connected to the Internet.
2. Visit the local website from www.BenQ.com. The website layout and content may vary by region/country.
 - User manual and related document: www.BenQ.com > **Business** > **SUPPORT** > **Downloads** > model name > **User Manual**
 - (EU only) Dismantled information: Available on the user manual download page. This document is provided based on Regulation (EU) 2019/2021 to repair or recycle your product. Always contact the local customer service for servicing within the warranty period. If you wish to repair an out-of-warranty product, you are recommended to go to a qualified service personnel and obtain repair parts from BenQ to ensure compatibility. Do not disassemble the product unless you are aware of the consequences. If you cannot find the dismantled information on your product, contact the local customer service for assistance.

EPREL Registration Number:

SL4302K: 370416

SL5502K: 370422

SL6502K: 370818

Table of Contents

Product support.....	3
Safety warnings and precautions.....	6
Important safety instructions.....	7
Notes on the LCD panel of this display	7
Safety notice for remote control	8
Battery safety notice	8
BenQ ecoFACTS	9
Package contents	10
Setting up the display.....	11
Mounting the display	11
Installing the display on a wall.....	11
Mounting in portrait position.....	12
Parts of the display and their functions.....	13
Rear panel.....	13
Input/output terminals	14
Remote control.....	15
Using the remote control	16
Connection	17
Connecting audio/video signals.....	17
Connecting power	18
Basic operations.....	19
Turning the display on or off.....	19
Switching input signals.....	20
Adjusting audio volume level.....	20
Operations in the OSD menu.....	21
Initial setup	22
Setting	22
Downloading software.....	23
Setting up the Internet connection.....	23
Updating software.....	24
Menu operations.....	26
Android Input	26
Other Input	36

Android system interface.....	39
Main interface	39
Multimedia files.....	40
APPS.....	46
Menu	46
X-Sign	47
About All Apps	49
Blizz	50
WPS Office	51
BenQ Suggests	53
InstaShare	54
Product information.....	56
Specifications	56
Dimensions	58
Supported input signal resolution.....	61
Troubleshooting	62

Safety warnings and precautions



The lightning flash with arrowhead symbol, within an equilateral triangle, is intended to alert the user to the presence of uninsulated “dangerous voltage” within the product’s enclosure that may be of sufficient magnitude to constitute a risk of electric shock to persons.



The exclamation point within an equilateral triangle is intended to alert the user to the presence of important operating and maintenance (servicing) instructions in the literature accompanying the appliance.



THIS EQUIPMENT MUST BE GROUNDED

To ensure safe operation, the three-pin plug must be inserted only into a standard three-pin power outlet which is effectively grounded through normal household wiring. Extension cords used with the equipment must have three cores and be correctly wired to provide connection to the ground. Wrongly wired extension cords are a major cause of fatalities.

The fact that the equipment operates satisfactorily does not imply that the power outlet is grounded or that the installation is completely safe. For your safety, if you are in any doubt about the effective grounding of the power outlet, please consult a qualified electrician.

- The mains plug of the power supply cord shall remain readily operable. The AC receptacle (mains socket outlet) shall be installed near the equipment and shall be easily accessible. To completely disconnect this equipment from the AC mains, disconnect the power cord plug from the AC receptacle.
- Do not place this display on an uneven, sloping or unstable surface (such as a trolley) where it may fall and cause damage to itself or others.
- Do not place this display near water, like a spa or pool, or in a position which will allow the splashing or spraying of water onto the display, like in front of an open window where rain water may enter.
- Do not install this display in a confined space without proper ventilation and air circulation, such as in a closed cabinet. Allow proper space around the display for dissipating heat inside. Do not block any openings and vents on the display. Overheating may result in hazards and electric shock.
- Installation of this display should only be performed by a qualified technician. Failure to install this display properly may cause injuries and damages to the personnels and the display itself. Check the installation regularly and maintain the display periodically to ensure the best working condition.
- Use only the accessories approved or recommended by the manufacturer to mount this display. Using wrong or unsuitable accessories may cause the display to fall and result in serious personal injuries. Make sure that the surface and fixing points are strong enough to sustain the weight of the display.
- To reduce the risk of electric shock, do not remove covers. No user serviceable parts inside. Refer servicing to qualified service personnel.
- To prevent personal injuries, mounting the display or installing desktop stands is required before use.

Important safety instructions

1. Read these instructions.
2. Keep these instructions.
3. Heed all warnings.
4. Follow all instructions.
5. Do not use this apparatus near water.
6. Clean only with dry cloth.
7. Do not block any ventilation openings. Install in accordance with the manufacturer's instructions.
8. Do not install near any heat sources such as radiators, heat registers, stoves, or other apparatus (including amplifiers) that produce heat.
9. Do not defeat the safety purpose of the polarized or grounding-type plug. A polarized plug has two blades with one wider than the other. A grounding-type plug has two blades and a third grounding prong. The wide blade or the third prong are provided for your safety. If the provided plug does not fit into your outlet, consult an electrician for replacement of the obsolete outlet.
10. Protect the power cord from being walked on or pinched particularly at plugs, convenience receptacles, and the point where they exit from the apparatus.
11. Only use attachments/accessories specified by the manufacturer.
12. Use only with the cart, stand, tripod, bracket, or table specified by the manufacturer, or sold with the apparatus. When a cart is used, use caution when moving the cart/apparatus combination to avoid injury from tip-over.
13. Unplug this apparatus during lightning storms or when unused for long periods of time.
14. Refer all servicing to qualified service personnel. Servicing is required when the apparatus has been damaged in any way, such as power-supply cord or plug is damaged, liquid has been spilled or objects have fallen into the apparatus, the apparatus has been exposed to rain or moisture, does not operate normally, or has been dropped.



Notes on the LCD panel of this display

- The Liquid Crystal Display (LCD) panel of this display has a very thin protective layer of glass which is liable to marking or scratching, and cracking if struck or pressured. The liquid crystal substrate is also liable to damage under excessive force or extreme temperatures. Please handle with care.
- The response time and brightness of the LCD panel may vary with the ambient temperature.
- Avoid placing the display in direct sun or where direct sun or spot lighting will shine onto the LCD panel, as the heat may damage the panel and the external casing of the display, and the bright light will make viewing the display more difficult than necessary.
- The LCD panel consists of individual pixels to display images and is manufactured according to the design specifications. While 99.9% of these pixels work normally, 0.01% of the pixels may remain constantly lit (in red, blue or green) or unlit. This is a technical limitation of the LCD technology and is not a defect.

- LCD screens, like plasma (PDP) and conventional CRT (Cathode Ray Tube) screens, are also susceptible to 'screen burn-in' or 'image retention' which can be found on the screen as visible fixed lines and shades. To avoid such damage to the screen, avoid displaying still images (like On-Screen Display menus, fixed/inactive text or icons) for more than 30 minutes. Change the aspect ratio from time to time. Fill the entire screen with the image and eliminate the black bars whenever possible. Avoid displaying images in 4:3 aspect ratio over a long period of time, otherwise there may be visible burn marks on the screen as two vertical lines.

Note: Under certain circumstances, condensation may occur on the inner side of the cover glass, it's a natural phenomenon and will not affect the operation of the display. This condensation will usually disappear after around 2 hours of normal operation.

- SL series does not offer image retention function, for more information, please refer to installation guide.
- For SL series, when the power goes out unexpectedly, please make sure the time zone is correctly synced via the Internet, otherwise manual adjustment is needed.

Safety notice for remote control

- Do not put the remote control in the direct heat, humidity, and avoid fire.
- Do not drop the remote control.
- Do not expose the remote control to water or moisture. Failure to do so could result in malfunction.
- Confirm there is no object between the remote control and the remote sensor of the product.
- When the remote control will not be used for an extended period, remove the batteries.

Battery safety notice

The use of the wrong type of batteries may cause chemical leaks or explosion. Please note the following:

- Always ensure that the batteries are inserted with the positive and negative terminals in the correct direction as shown in the battery compartment.
- Different types of batteries have different characteristics. Do not mix different types.
- Do not mix old and new batteries. Mixing old and new batteries will shorten battery life or cause chemical leaks from the old batteries.
- When batteries fail to function, replace them immediately.
- Chemicals which leak from batteries may cause skin irritation. If any chemical matter seeps out of the batteries, wipe it up immediately using a dry cloth, and replace the batteries as soon as possible.
- Due to varying storage conditions, the battery life for the batteries included with your product may be shortened. Replace them within 3 months or as soon as you can after initial use.
- There may be local restrictions on the disposal or recycling of batteries. Consult your local regulations or waste disposal provider.

BenQ ecoFACTS

BenQ has been dedicated to the design and development of greener product as part of its aspiration to realize the ideal of the “Bringing Enjoyment 'N Quality to Life” corporate vision with the ultimate goal to achieve a low-carbon society. Besides meeting international regulatory requirement and standards pertaining to environmental management, BenQ has spared no efforts in pushing our initiatives further to incorporate life cycle design in the aspects of material selection, manufacturing, packaging, transportation, using and disposal of the products. BenQ ecoFACTS label lists key eco-friendly design highlights of each product, hoping to ensure that consumers make informed green choices at purchase. Check out BenQ's CSR Website at <http://csr.BenQ.com/> for more details on BenQ's environmental commitments and achievements.



~ AC voltage

Package contents

Open the sales package and check the contents. If any item is missing or damaged, please contact your dealer immediately.



LCD display

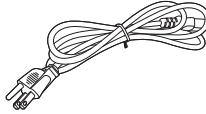

Power cord x 7

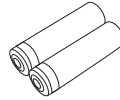

AAA battery x 2



Remote control

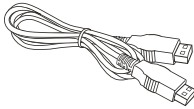

HDMI cable x 1

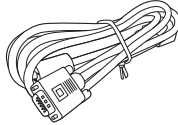

VGA cable x 1

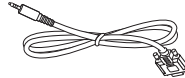

RS232 cable x 1



Quick start guide



- The type of power cord supplied may differ from that illustrated depending on your region of purchase.
- Before discarding the package, check that you haven't left any accessories inside the box.
- Dispose of packaging materials wisely. You can recycle the cardboard carton. Consider storing the package (if possible) for future transport of the display.
- Do not leave plastic bags within reach of young children or babies.

Setting up the display

Mounting the display

You can install the display on a vertical surface with a suitable wall mounting bracket or on a horizontal surface with the optional desktop stands. Please pay attention to the following notes during installation:

- This display should be installed by at least two adult persons. Attempting to install this display by only one person may result in danger and injuries.
- Refer the installation to qualified technicians. Improper installation may cause the display to fall or malfunction.

Installing the display on a wall

VESA Standard:

SL4302K: 400 × 400 (4 - M6)

SL5502K: 400 × 400 (4 - M6)

SL6502K: 400 × 400 (4 - M8)

1. Place a clean, dry and lint-free cloth on a flat, horizontal and object-free surface. Make sure that the size of the cloth is larger than the display.
2. Gently lay the display on the cloth with the LCD screen facing down.
3. Remove the desktop stands from the display if installed.
4. Identify the wall mounting screw holes on the back of the display as shown in the illustration.

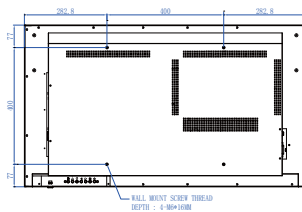

SL4302K

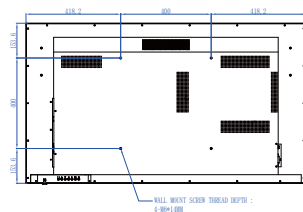

SL5502K

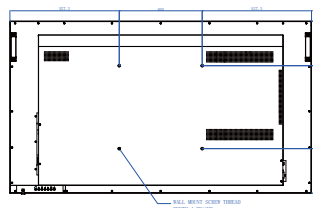

SL6502K

5. Install the wall mounting bracket on the display and attach the display to the wall according to the mounting bracket's instructions. The length of the screw should exceed the thickness of the wall mounting bracket, please refer to below chart for each model. Make sure that all screws are tightened and secured properly. (Recommended torque: 16 (+2/-2) kgf/cm). The mounting means should be strong enough to bear the weight of the display.

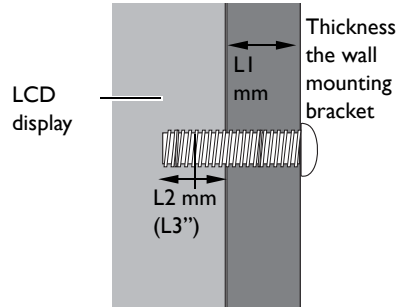

- To maintain proper ventilation, keep at least 10 mm of clear space from the back cover of the display to the wall.
- Please consult a professional technician for wall mount installations. The manufacturer accepts no liability for installations not performed by a professional technician.

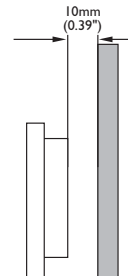

Mounting in portrait position

This display can be installed in portrait position.

1. Remove the table stand, if attached.
2. Rotate 90 degrees clockwise from the back side of the display. The terminals will be on the left and bottom side of the user from the back of the display.

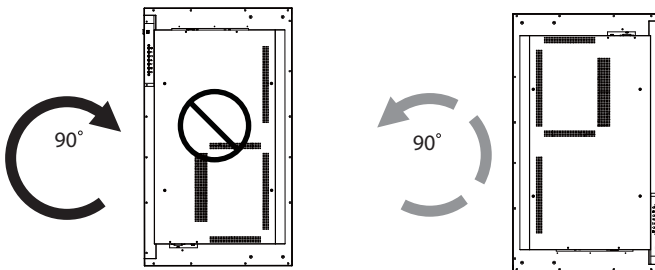

Parts of the display and their functions

Rear panel

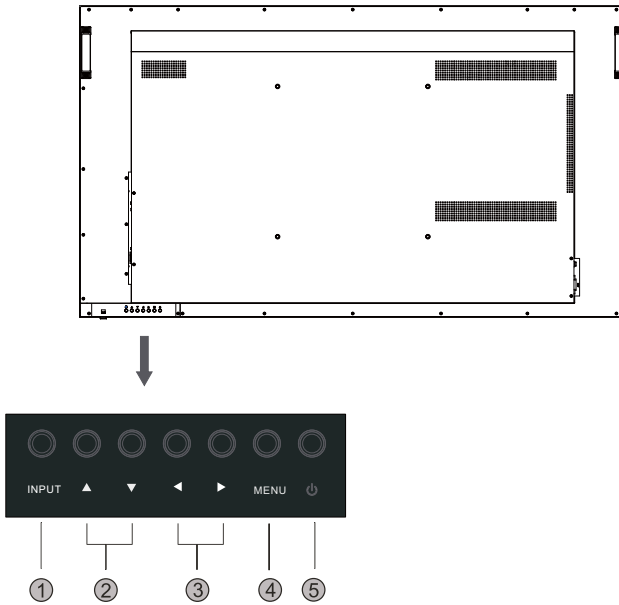

No.	Name	Description
1	INPUT	<ul style="list-style-type: none"> • Select/confirm options in On-Screen Display (OSD) menu. • Select input sources.
2	▲/▼	Scroll through settings and options in the OSD menu up and down.
3	◀/▶	<ul style="list-style-type: none"> • Scroll through settings and options in the OSD menu. • Hot keys for audio volume adjustment.
4	MENU	Open or close the OSD menu.
5	⏻	Turn the display on or off.

Input/output terminals

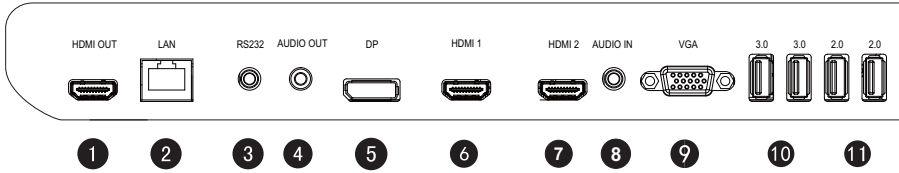

No.	Name	Description
1	HDMI OUT	Connects to display devices with an HDMI input.
2	LAN	10/100 LAN interface, connecting RJ45 terminals.
3	RS232	Serial interface, used for mutual transfer of data between devices.
4	AUDIO OUT	Connects to an external audio device (such as a speaker, stereo system, or headphone) to output the audio that is supplied by the video source.
5	DP	Connect a video source to a display device.
6	HDMI 1	Receive 4K2K 60Hz supported signals from an external device.
7	HDMI 2	Receive 4K2K 60Hz supported signals from an external device.
8	AUDIO IN	Receives audio signals from an external device.
9	VGA	Receive analog RGB signals from an external device (such as a computer).
10	2.0	Access multimedia files on USB drives directly.
11	3.0	Access multimedia files on USB drives directly.

Remote control

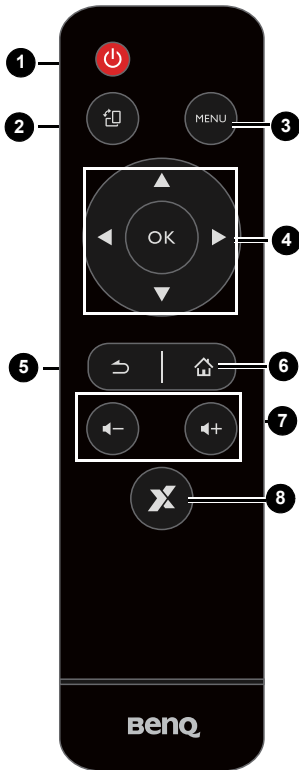

1 Power button

Turns the display on or off.

2

Supports landscape and portrait screen rotation.

3 MENU

Opens or closes the OSD menu.

4 ▲/▼/◀/▶/OK

Scrolls through settings and options in the OSD menu when the OSD menu is on.

5 BACK

Return key.

6 HOME

Android system main screen button.

7 Volume +/-

Turns up/down the volume.

8 X-Sign

Opens the X-Sign app in Android.

Using the remote control

Installing remote control batteries

1. Open the remote control battery compartment cover.

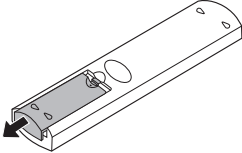

2. Insert the batteries ensuring that the positive and negative marked battery terminals match the (+) and (-) marks in the battery compartment.

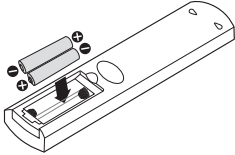

 Batteries must be purchased separately as they are not included in the display package.

3. Refit the battery compartment cover.

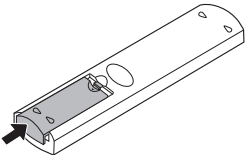

Remote control usage tips

- Point and aim the top front of the remote control directly at the display's remote control sensor window when you press the buttons.
- Do not let the remote control become wet or place it in humid environments (like bathrooms).
- If the display's remote control sensor window is exposed to direct sunlight or strong light, the remote control may not operate properly. In this situation, change the light source, readjust the angle of the display or operate the remote control from a location closer to the display's remote control sensor window.

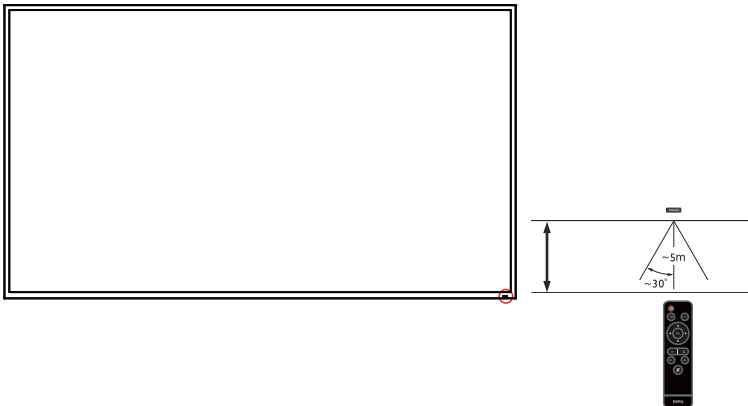

Connection

Connecting audio/video signals

Pay attention to the following notes when you connect cables:

- Please turn off all devices.
- Familiarize yourself with the audio/video ports on the display and the devices you want to use. Be aware that incorrect connections may adversely affect picture quality.
- Do not remove cables from the ports by pulling the cable itself. Always grasp and pull the connectors at the end of the cable.
- Ensure that all cables are fully inserted and firmly seated.

Connecting the digital inputs

1. Connect the **VGA** jack on the display to the VGA output jack on a computer using a D-Sub (15-pin) cable.
2. Connect the computer's audio output jack to the **AUDIO IN** jack on the display using a suitable audio cable.
3. Connect the HDMI output jack of a computer or A/V device (such as a VCR or DVD player) to the HDMI input jack on the display using an HDMI cable.
4. To view a video image from this input, press the **INPUT** button and choose HDMI.

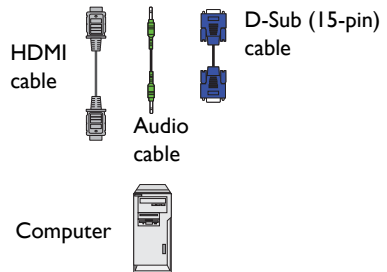
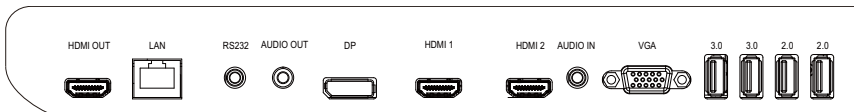

Connecting the multimedia inputs

To view multimedia files on the USB flash drive, plug the USB flash drive in the **USB** port.

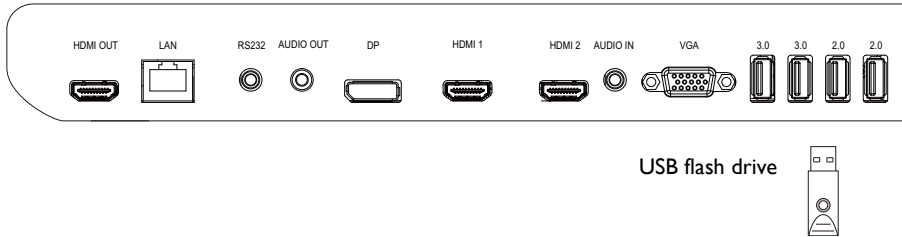

USB 2.0 standard spec is 0.5A and USB 3.0 standard spec is 0.9A.

Connecting power

Plug one end of the power cord into the **Power** jack on the display and the other end into an appropriate power outlet (if the outlet is switched, turn on the switch).

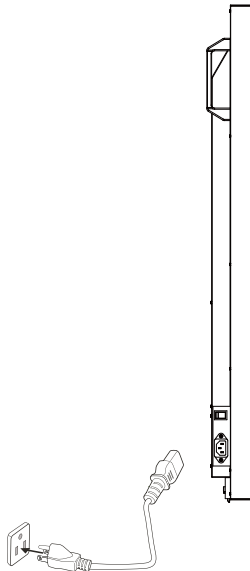

- The supplied power cord is suitable for use with 100-240V AC power only.
- The power cord and outlet illustrated may differ from the ones used in your region.
- Only use an appropriate power cord for your region. Never use a power cord which appears damaged or frayed, or change the plug type on the power cord.
- Be aware of the power loading when you use extension cords or multiple outlet power boards.
- There are no user serviceable parts in this display. Never unscrew or remove any covers. There are dangerous voltages inside the display. Turn off the power and unplug the power cord if you intend to move the display.

Basic operations

Turning the display on or off

1. Be sure to follow the instruction of [Connecting power on page 18](#).
2. Before turning on the display, make sure the Power switch is set to ON. The system will enter standby mode.

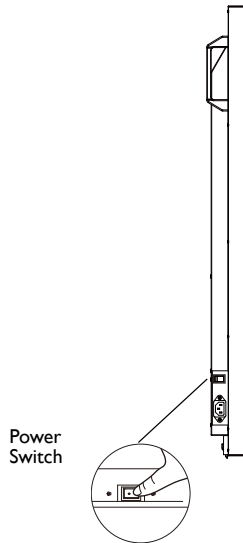

The display's standby mode still consumes power. To completely cut off power supply, set the Power switch to OFF (○) and then disconnect the power cord from the power outlet.

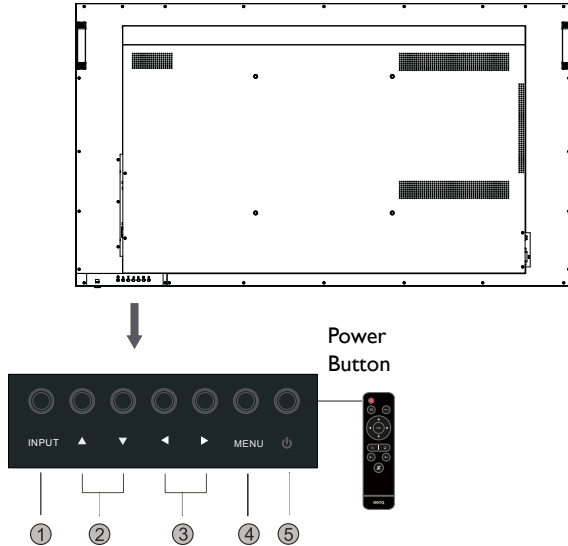

- Only by switching on the master switch will either power button work. To turn on or off the display, press the power button on the display's control panel or on the remote control.
 - Turning off the power still consumes power. The users have to un-plug the plug to completely cut off the power supply.
-







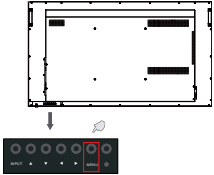

Switching input signals

Press the **INPUT** button and those signal selection buttons on the remote control or the **INPUT** button on the control panel to select an input signal.

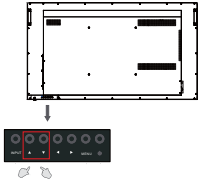
Adjusting audio volume level

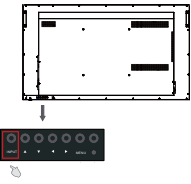
- Press **◀ / ▶** on the control panel or **VOL- / VOL+** on the remote control to adjust the volume.
- Go to **General > Audio** to adjust the volume. Refer to [Audio Settings on page 27](#) for more information.

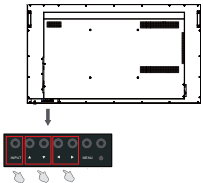
Operations in the OSD menu

Using the control panel buttons	Using the remote control
<p>1. Press MENU to open the OSD menu.</p> 	<p>1. Press MENU to open the OSD menu.</p> 
<p>2. In the OSD menu, press ▲ or ▼ to select an item.</p> 	<p>2. Press ▲ or ▼ to select an item.</p> 
<p>3. Press INPUT to confirm selections.</p> 	<p>3. Press MENU to open the OSD menu, then press ◀ to go to Connection to select the input source.</p> 
<p>4. Press ◀ or ▶ to adjust settings and press ▲ or ▼ to select a feature. Press INPUT to save changes.</p> 	<p>4. Press ▲ and ▼ to select a feature and press ◀ or ▶ to adjust settings. Press OK to confirm changes.</p> 

5. Press **MENU** to close the OSD menu.

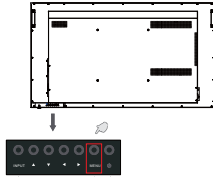

5. Press **BACK** to close the OSD menu.

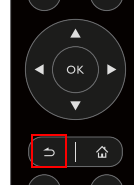

Initial setup

After you have connected the display to the power, you are ready to power on the display. The first time you power on the display, you will be guided through a series of setup screens. Follow the on-screen instructions or the steps below to start up your display and complete the initial setup.

1. Turn on the display. Wait for the display to boot up with the BenQ screen. This may take a moment.
2. Select **Next** on the screen to begin. Follow the on-screen instructions to set up the language, date and time, and network. Or you can skip some of these steps and complete the setup later.

Setting

- Press **MENU** on the remote control or **MENU** button on the panel to enter the OSD menu. You can also select **Setting** on the home screen to go to the OSD menu.

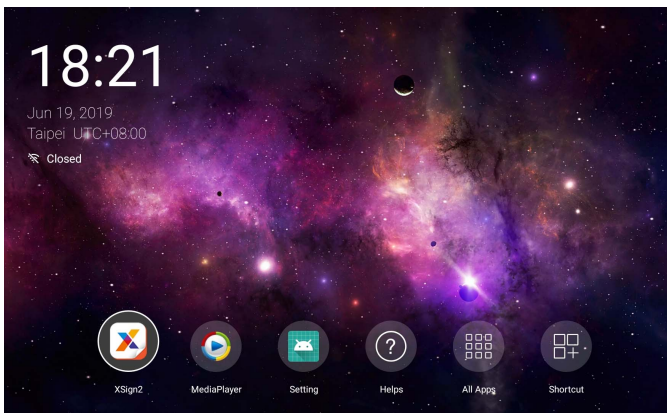

- Under **Connection**, you can select a desired input source. Refer to [Connection settings on page 26](#) for more information.

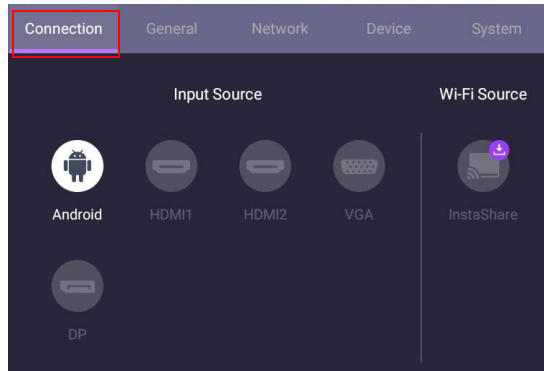

InstaShare is not preloaded. You need to download the app via BenQ Suggests. Refer to [InstaShare on page 54](#) for more information.

Downloading software

BenQ may periodically release software updates that may add functions or applications associated with your display. To check if there is a software update available for your device or to obtain the software license key, please visit <http://DSdownload.BenQ.com>. Then enter the serial number (can be found on the sticker attached on the back of the display) and click **OK** to access the Software download page.

Setting up the Internet connection

Your display must be connected to a network to conduct OTA updates or surf the Internet.



To find the MAC address in Android OS, please go to **Setting > System > About > Status**.

Network setting

On the home screen, go to **Setting > System > About > Status**. If there is no IP address shown, please connect the display to the ethernet cable.

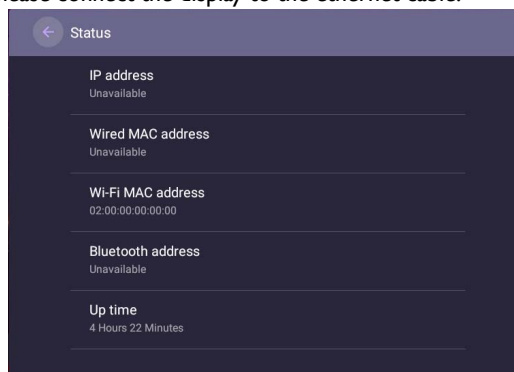

Wireless connection

You must use a wireless adapter in order to connect the display to the Internet wirelessly. Please contact your local dealer for more information on configuring the wireless connection.

1. Press **MENU** on the remote control, or go to **Network > WI-Fi**.

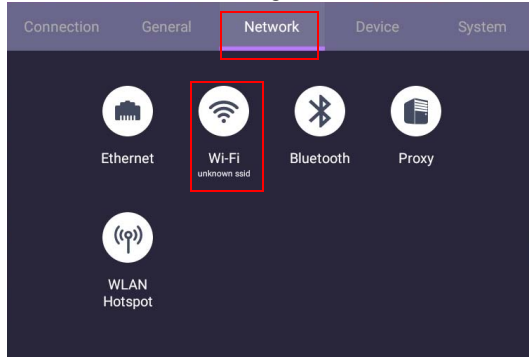

2. Set the switcher to **On**. A list of available networks will show on the screen.

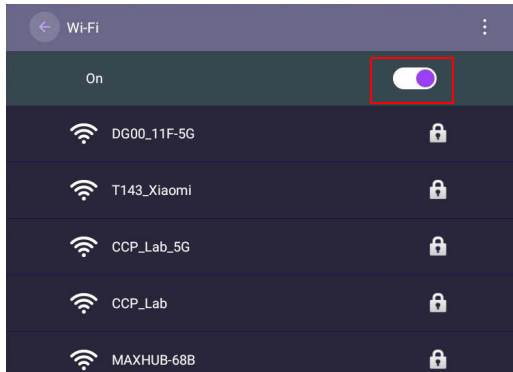

3. Press **▲/▼/◀/▶** on the remote control to select the network's name and connect to the network. The password is needed if it is your first time to use the network. Key in the password and press **Connect**. The device is now connected to the WLAN.

Updating software

Whenever a new version of software is available, the system will automatically detect the update and will prompt you to download it every time you turn on the display. If you

want to update the software, choose **NETWORK UPDATE** or **USB UPDATE** to continue the update. Or you can skip this step and update the software later.

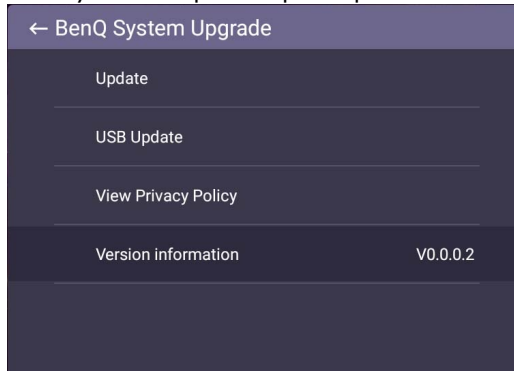

To manually update the software:

1. Go to **System > About > System updates**.

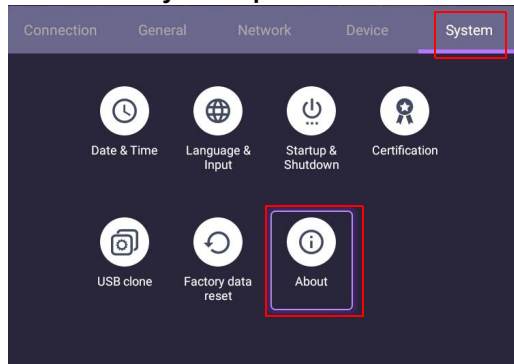

2. If there is an update available, the system will begin updating.



- Software update process may take some time to complete.
- During the update process, do not turn off the device or disconnect the Internet connection. Any interruptions during the software update process may permanently damage your display.

Menu operations

Android Input

Connection settings

Press **MENU** on the remote control or **MENU** button on the panel to enter the OSD menu.

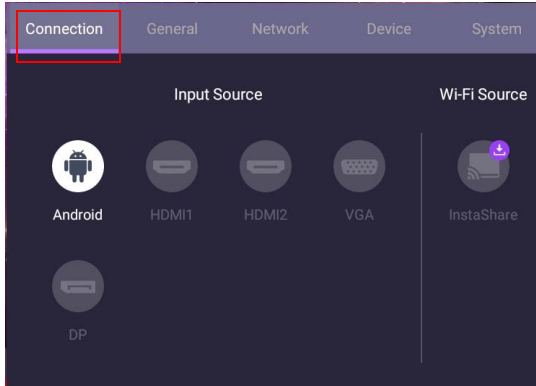

- Press **▲/▼/◀/▶** on the remote control and press **OK** to select a desired input source.
- Press **↩** on the remote control to exit the menu.

General settings

Go to **General** to access to the **Audio** and **Picture** settings.

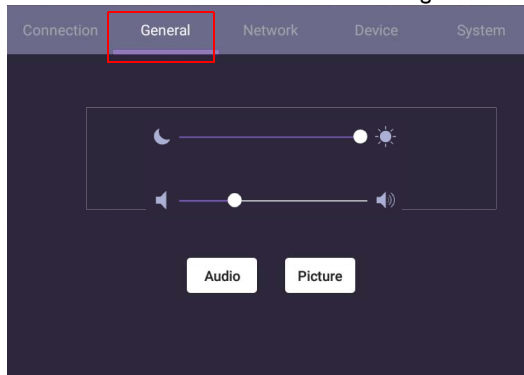

- Use the light bar to adjust the backlight.
- Use the volume bar to adjust the volume for the display.
- Go to **Audio** settings to enter **Audio** menu.
- Go to **Picture** settings to enter **Picture** menu.

Audio Settings

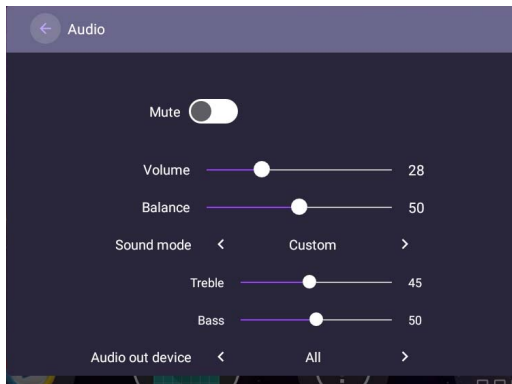
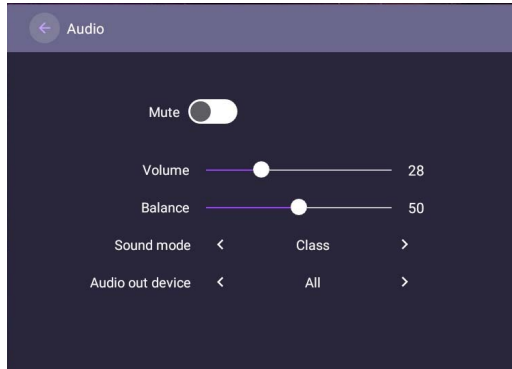

- Press ▲/▼/◀/▶ on the remote control and press **OK** to adjust the settings.
- Press  on the remote control to exit the menu.

Menu	Description
Volume	Press ◀/▶ on the remote control to adjust the volume.
Balance	Press ◀/▶ on the remote control to adjust the balance.
Sound mode	Select a preset sound environment. Options are Standard , Class , Meeting , Movie , or Custom .
Treble	Press ◀/▶ on the remote control to adjust the treble.
Bass	Press ◀/▶ on the remote control to adjust the bass.

Picture Settings

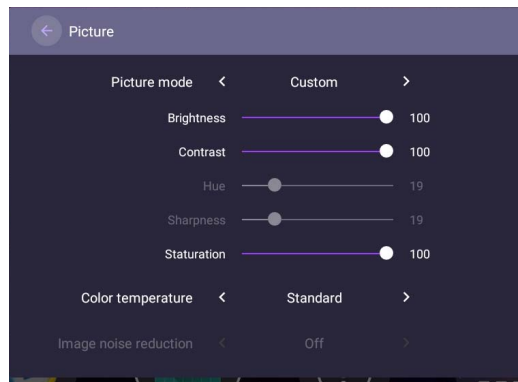
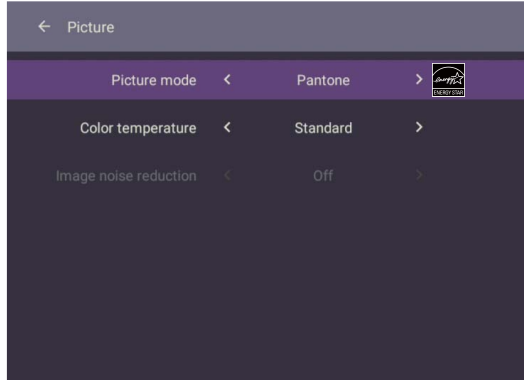

- Press **▲/▼/◀/▶** on the remote control and press **OK** to confirm.
- Press **⏪** on the remote control to exit the menu.

Menu	Description
Picture mode	Press ◀/▶ on the remote control. Options are Pantone, M-Book, Cinema, Photo, Custom . Refer to PANTONE Color Explanation on page 29 for more information about variables.
Brightness	Press ◀/▶ on the remote control to adjust the brightness.
Contrast	Press ◀/▶ on the remote control to adjust the contrast.
Saturation	Press ◀/▶ on the remote control to adjust the saturation.
Color temperature	Press ◀/▶ on the remote control or click a preset color temperature for the image. Options are Cool, Warm, Standard .

PANTONE Color Explanation

There are many variables in process reproduction of colors generated by SL4302K/SL5502K/SL6502K, any one of which may affect the quality of the PANTONE Color simulation, including:

Print Devices

- type of driver or RIP used
- type of paper used
- type of ink, toner or colorant used
- resolution
- rendering intent used
- dot structures/halftones/screening
- print engine
- other print settings

Display Devices

- hardware device settings
- graphics card used
- backlight panel settings
- selected resolution
- operating system
- selected refresh rate
- calibration method
- other display settings

Device settings

Go to **Device** to enter the **Device** menu.

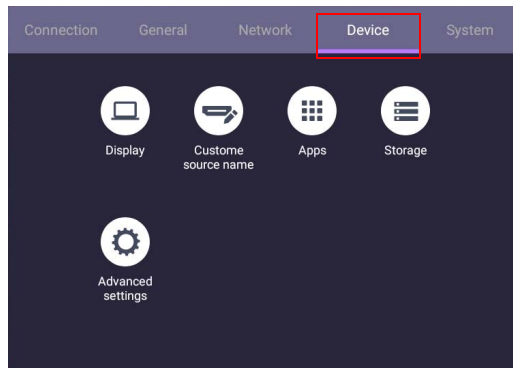

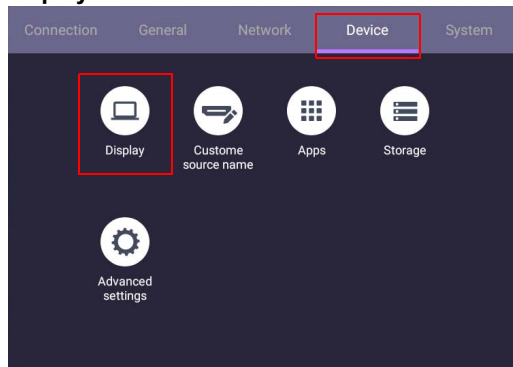

Display

Go to **Device** > **Display**.

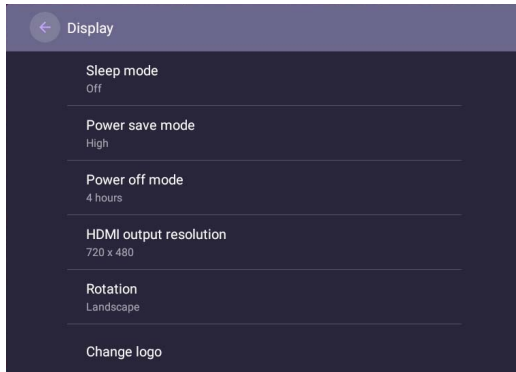

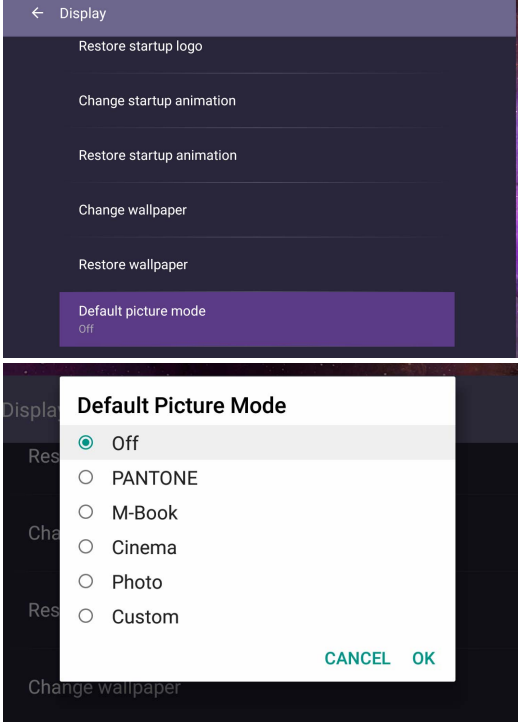

Menu	Description
Sleep mode	This feature only works on Android input. <ul style="list-style-type: none"> • Select a time period (1, 5, 10, 20, 30, 40, 50 minutes or 1, 2, 3, 4 hours) for the display to turn off the panel back light. • Set to Off to turn off the function.
Power save mode	This feature only works on VGA/HDMI input. <ul style="list-style-type: none"> • High: Power off the display five minutes later. • Low: Turn off the panel back light five minutes later. • Off: Turn off the function.
Power off mode	This feature only works on Android input. <ul style="list-style-type: none"> • Select a time period (1, 5, 10, 20, 30, 40, 50 minutes or 1, 2, 3, 4 hours) to turn off the display. • Set to Off to turn off the function.
HDMI output resolution	Select the resolution for the HDMI output.
Rotation	<ul style="list-style-type: none"> • Switch the landscape and portrait mode. • To change the orientation from landscape to portrait, rotate the display in clockwise direction.
Change logo	<ul style="list-style-type: none"> • Copy the boot logo file (JPG format, *.jpg, with resolution supports the display) to USB drive under “benq” folder. Rename the image to “bootlogo.jpg”. • Click Change logo to load the changed logo.
Restore logo	Click Restore logo to restore the original logo.
Change animation	<ul style="list-style-type: none"> • Copy animation zip file (<2MB) to USB drive under “benq” folder. Rename the file to “bootanimation.zip”. • Click Change animation to load the changed animation.
Restore animation	Click Restore animation to restore the original animation.

<p>Change wallpaper</p>	<ul style="list-style-type: none"> • To change the wallpaper, you need to create a benq directory under the FAT32 format USB drive and put the image into it.  The file format options are JPG and PNG. If you have both JPG and PNG files in the same folder, the JPG file will be used first. • For horizontal wallpaper, the file name must be “wallpaper.jpg” or “wallpaper.png”. For portrait wallpaper, the file name must be “wallpaperportrait.jpg” or “wallpaperportrait.png”.  The device supports a resolution of (up to) 3840 x 2160 or 2160 x 3840. If the image is smaller than this size, it will not be enlarged and will be displayed in its original size in the center of the screen. • Click Change wallpaper to change the wallpaper.
<p>Restore wallpaper</p>	<p>Click Restore wallpaper to restore the original wallpaper.</p>
<p>Default picture mode</p>	<ul style="list-style-type: none"> • Click Default picture mode to select a picture mode.  <ul style="list-style-type: none"> • After restarting the device, the system will enter the default picture mode that has been set up, regardless of the last selection made by the user.

Custom source name

You can change Custom source name. Enter a value within six characters long.

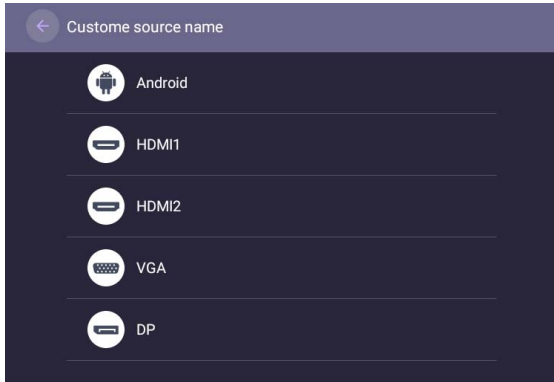

Advanced settings

Go to **Device** > **Advanced settings**.

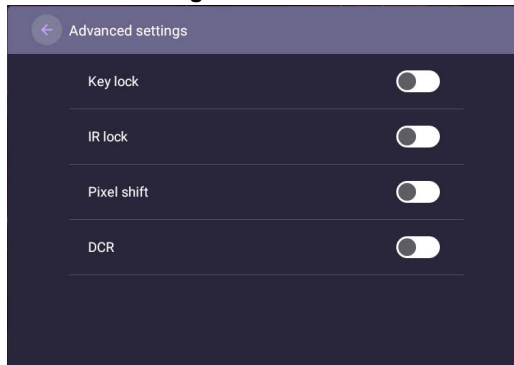

- Press **▲/▼/◀/▶** on the remote control and press **OK** to confirm.
- Press **⏪** on the remote control to exit the menu.

Menu	Description
Key lock	Press ◀/▶ and OK on the remote control to enable or disable Key lock .
IR lock	Press ◀/▶ and OK on the remote control to enable or disable IR lock .
Pixel shift	Press ◀/▶ and OK on the remote control to set a pixel shift preventing from image retention.
DCR	Press ◀/▶ and OK on the remote control to enable or disable DCR .



- The **Key lock** and **IR lock** functions can be enabled at the same time.
- For image retention, please see [Notes on the LCD panel of this display on page 7](#) for more information.

Proxy setting

- Go to **Network > Proxy**.

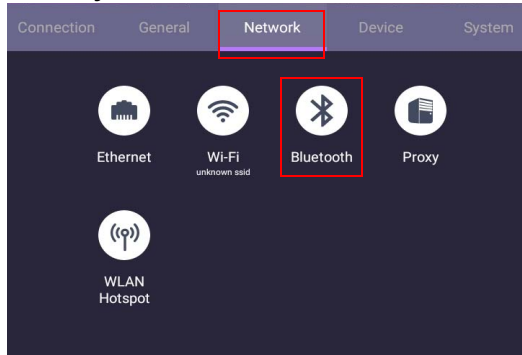

- Check the box of **Proxy Switch** to enable or disable the function.

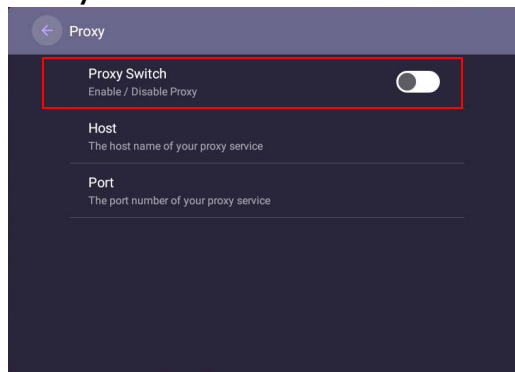

- Enter the proxy host name.

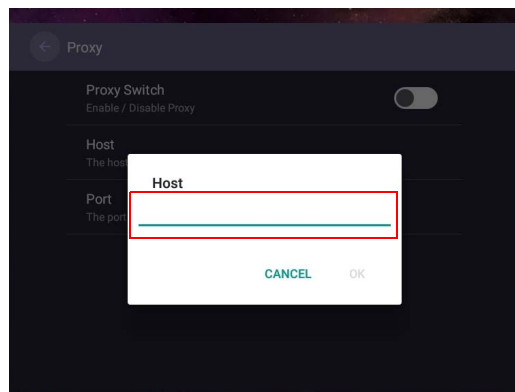

- Enter the using channel.

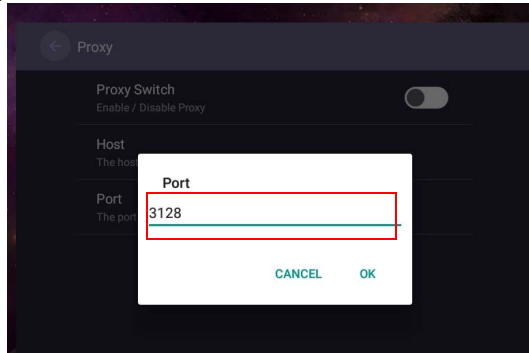

System settings

Go to **System** to enter the **System** menu.

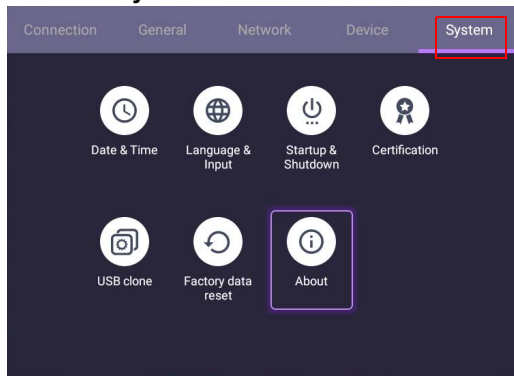

- Press **▲/▼/◀/▶** on the remote control and press **OK** to confirm.
- Press **➔** on the remote control to exit the menu.

Options	Description
Date & time	Select to set date, time, and their formats in Android.
Language & input	Select to set Language, Keyboard & Input methods in Android.
Startup & Shutdown	Select to set Startup channel, Wake on LAN, and Power off reminder . Refer to Startup & Shutdown on page 35 for more information.
USB clone	Click to export/import the setting.
Factory data reset	Select Factory data reset to erase all data from the display.
About	Select to view system information in Android.



The amount of available storage space for the user varies according to the amount of pre-installed apps and images occupying the total storage space.

Startup & Shutdown

- Go to **System > Startup & Shutdown**.

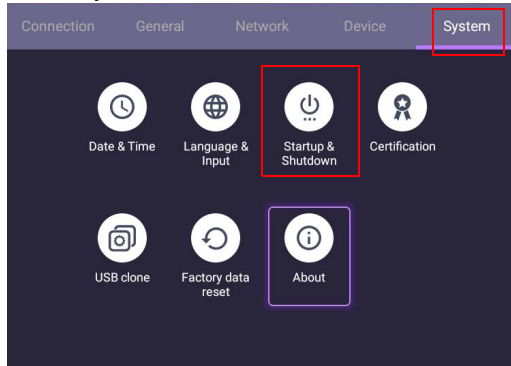

- For **Startup channel**, you can choose **Last channel**, **Android** or other sources listed below.

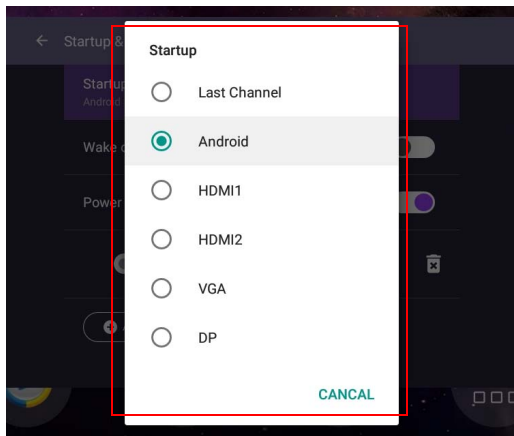
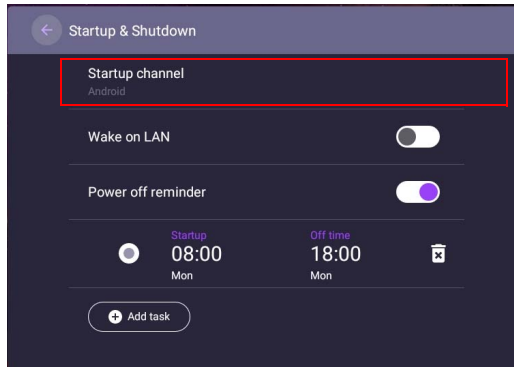

- For **Power off reminder**, you can adjust startup and shutdown time. Schedules can be made by choosing the days of the week.

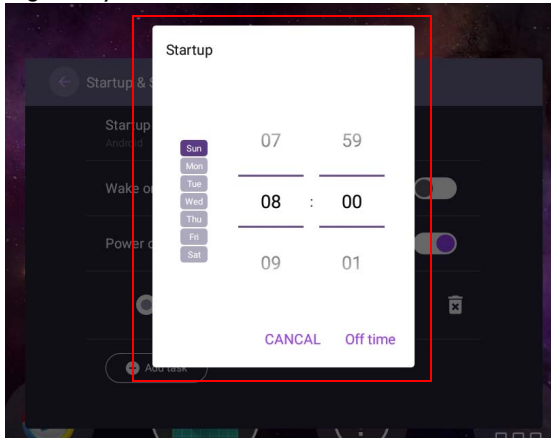

Other Input

Display settings

Leave the Android system and connect to other input sources like VGA, DP, or HDMI. Then go to **Display**.

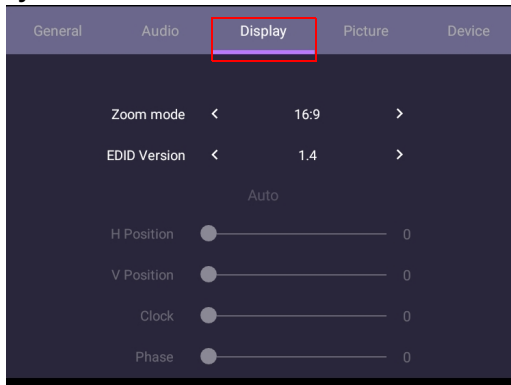

- Press **▲/▼/◀/▶** on the remote control and press **OK** to confirm.
- Press **↩** on the remote control to exit the menu.

Menu	Description
Zoom mode	Press ◀/▶ on the remote control. Options are 16:9, 4:3, 1:1, Full . You can also select Auto to adjust the image.
EDID Version	Press ◀/▶ on the remote control and press OK to confirm. Options are EDID 1.4, EDID 2.0 .

- The display automatically enters energy saving mode when no one is detected within the sensor's range.

- The display automatically turns off when no one is detected within the sensor's range for a long period of time.

Adjust settings (VGA-only)

Use the **H. Position**, **V. Position**, **Clock**, and **Phase** functions to manually adjust the image.

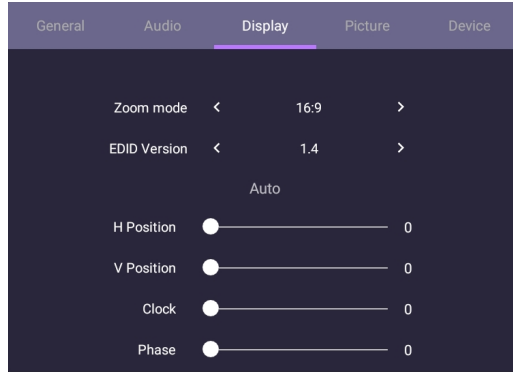



Menu	Description
H. Position	Press ◀ / ▶ on the remote control to move the screen to the left or right.
V. Position	Press OK on the remote control to lock or unlock the remote control IR sensor on the front panel of the display.
Clock	Clock adjusts how wide the input pixels are. Press ◀ / ▶ on the remote control to make adjustments.
Phase	Phase is in relation to frequency. Press ◀ / ▶ on the remote control to make adjustments.

Picture settings

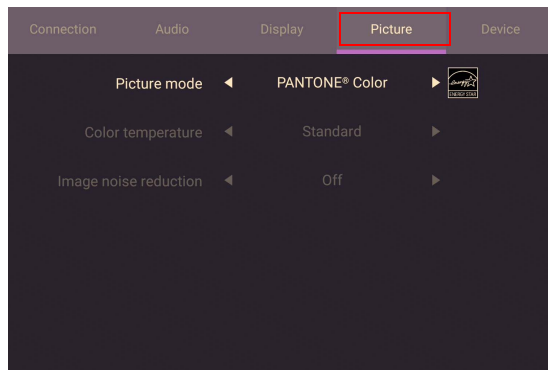
Leave the Android system and connect to other input sources like VGA, DP, or HDMI. Then go to **Picture**.

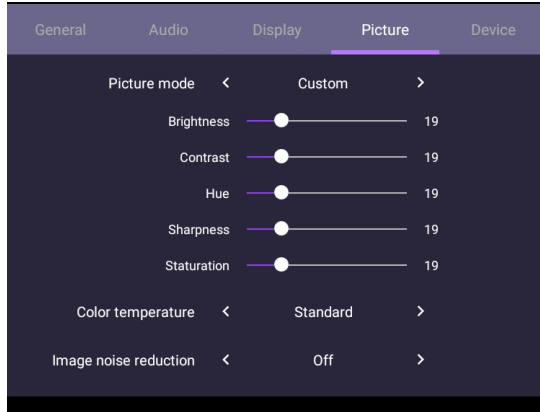



- Press ▲/▼/◀/▶ on the remote control and press **OK** to confirm.
- Press  on the remote control to exit the menu.

Menu	Description
Picture mode	Press ◀ / ▶ on the remote control. Options are PANTONE® Color, M-Book, Cinema, Photo, Custom . Refer to PANTONE Color Explanation on page 29 for more information about variables.
Brightness	Press ◀ / ▶ on the remote control to adjust the brightness.
Contrast	Press ◀ / ▶ on the remote control to adjust the contrast.
Hue	Press ◀ / ▶ on the remote control to adjust the hue.
Sharpness	Press ◀ / ▶ on the remote control to adjust the sharpness.
Saturation	Press ◀ / ▶ on the remote control to adjust the saturation.
Color temperature	Press ◀ / ▶ on the remote control or click a preset color temperature for the image. Options are Cool, Warm, Standard .
Image Noise Reduction	Press ◀ / ▶ on the remote control. Options are Off, Low, Middle, High .

Android system interface



Note that this is a closed Android OS. Download and use of unauthorized apps on this system are not available.

Main interface

The display launches the Android main interface by default.



To navigate the Android main interface, press **MENU** on the remote control to enter the OSD menu to select an input.

Multimedia files

1. To play image, audio, or video files, select  on the Android main interface.



2. Select the file you want to show on the display.

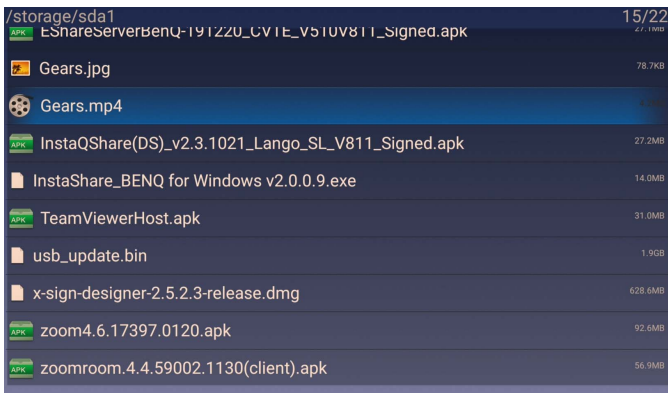
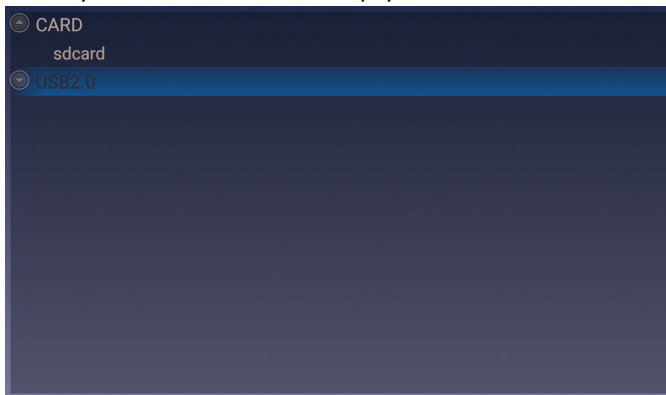

Picture

Select the file you want to show on the display and perform any of the functions shown on the screen.



Icon	Function
	Play the previous image.
	Play/pause the current playback.
	Play the next image.
	Magnify the current image.
	Shrink the current image.
	Rotate the current image counter-clockwise.
	Rotate the current image clockwise.
	See the information about the file name, creation time, file size, and the file format.
	Without function.
	Playing settings. <ul style="list-style-type: none"> • Animation effect is without function. • You can select playing interval time.

Supported image format (maximum resolution)





File	Image	Supported range
.bmp	BMP	Max Resolution: 8000 × 8000
		Min Resolution: 4 × 4

File	Image	Supported range
.gif	GIF	Max Resolution: 8000 × 8000
		Min Resolution: 4 × 4
.jpeg/.jpg	JPEG/JPG	Max Resolution: 8000 × 8000
		Min Resolution: 4 × 4
.png	PNG	Max Resolution: 8000 × 8000
		Min Resolution: 4 × 4

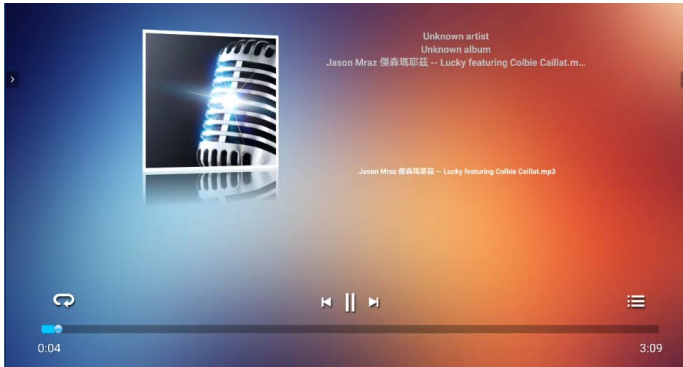
Audio

Select the file you want to show on the display and perform any of the functions shown on the screen.



Icon	Function
	Repeatedly play audio files in the playlist.
	Play the previous audio file.
	Play/pause the current audio file.
	Play the next audio file.
	Check the audio information.

Supported audio format (Codec)

File	Format	Audio Codec	Supported range
.aac	AAC	AAC	Sample Rate: 8K~96KHz
			Bit Rate: 24K~576Kbps

File	Format	Audio Codec	Supported range
.ape	Monkey's Audio	Monkey's Audio	Sample Rate: Max 48KHz
			Bit Rate: max 1411Kbps
.flac	FLAC	FLAC	Sample Rate: Max 192KHz
			Bit Rate: max 1411Kbps
.m4a	ALAC	ALAC	Sample Rate: 8K~96KHz
			Bit Rate: 24K~576Kbps
.mp3	MPEG Audio Layer3	MPEG1/2 layer3	Sample Rate: 8K~48KHz
			Bit Rate: 32K~320Kbps
.ogg	Vorbis	Vorbis	Sample Rate: 8K~48KHz
			Bit Rate: max 256Kbps
.wav	WAV	LPCM	Sample Rate: 8K~192KHz
			Bit Rate: max 320Kbps

Video

1. Press **MENU** on the remote control to access **Advanced Options** under the player menu.
2. In **Advanced Options**, you can set the playing mode to continue play, forward rewind, full-screen playback, single cycle, and 3D MVC adaption by pressing **MENU** on the remote control.

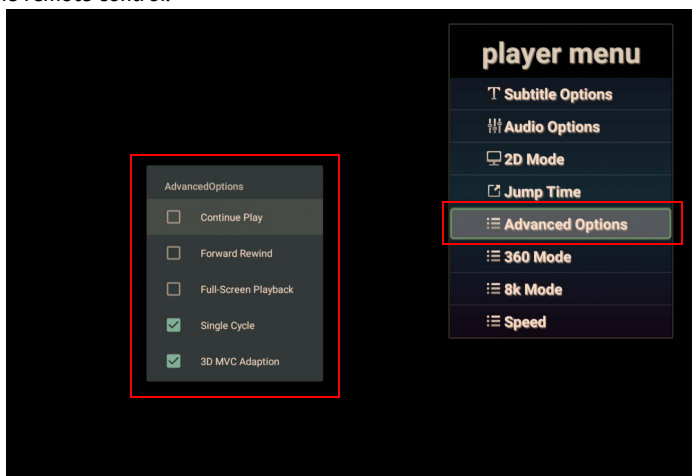

- Press **OK** on the remote control to perform any of the functions shown on the screen.

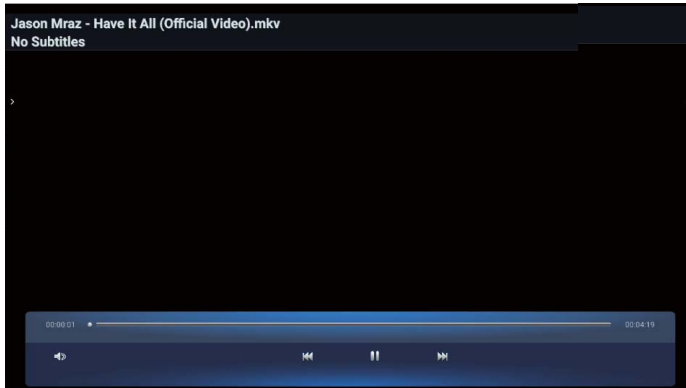

Icon	Function
	Adjust the video volume.
	Play the previous video file.
	Play/pause the current video file.
	Play the next audio file.

Supported video format (Codec) Up to 4K resolution

File	Codec		Maximum transmit ratio
Extensions	Video	Audio	
.3g2	H.263	AAC, AMR_NB	1920*1088 30 Fps, 5Mbps
.3gp	H.264		3840*2160 30 Fps, 160Mbps
	H.263		1920*1088 30 Fps, 5Mbps
	MPEG-4		1920*1088 30 Fps, 50Mbps
.avi	H.263	MPEG1/2 Layer3, AAC, LPCM	1920*1088 30 Fps, 5Mbps
	H.264		3840*2160 30 Fps, 160Mbps
	Mpge-1		1920*1088 30 Fps, 80Mbps
	MPEG-2		1920*1088 30 Fps, 80Mbps
	MPEG-4		1920*1088 30 Fps, 50Mbps
	MJPEG		1920*1080 30 Fps, 150Mbps







File	Codec		
Extensions	Video	Audio	Maximum transmit ratio
.flv	H.263	MPEG1/2 Layer3, AAC	1920*1088 30 Fps, 5Mbps
	VP6		1920*1088 30 Fps, 40Mbps
	H.264		3840*2160 30 Fps, 160Mbps
.f4v	H.264	AAC	3840*2160 30 Fps, 160Mbps
.mkv	H.264	AAC, MPEG1/2 Layer3	3840*2160 30 Fps, 160Mbps
	H.265		3840*2160 60 Fps, 160Mbps
	Vc-1		1920*1088 30 Fps, 45Mbps
.mov	H.264	AAC, PCM	3840*2160 30 Fps, 160Mbps
	H.265		3840*2160 60 Fps, 160Mbps
	MPEG-4		1920*1088 30 Fps, 50Mbps
	MJPEG		1920*1080 30 Fps, 150Mbps
.mp4	H.264	AAC	3840*2160 30 Fps, 160Mbps
	H.265		3840*2160 60 Fps, 160Mbps
	MPEG-4		1920*1088 30 Fps, 50Mbps
.VOB	MPEG-2	MPEG1/2	1920*1088 30 Fps, 80Mbps
.mpg/.MPEG	H.264	MPEG1/2 Layer3, AAC	3840*2160 30 Fps, 160Mbps
	MPEG-1		1920*1088 30 Fps, 80Mbps
	MPEG-2		1920*1088 30 Fps, 80Mbps
.ts	H.264	AAC AAC, MPEG1/2 Layer3	3840*2160 30 Fps, 160Mbps
	H.265		3840*2160 60 Fps, 160Mbps
	MPEG-2		1920*1088 30 Fps, 80Mbps
	MPEG-4		1920*1088 30 Fps, 50Mbps
	VC-1(AP)		1920*1088 30 Fps, 45Mbps

APPS



Using the remote control: Press the **▲/▼/◀/▶** button to select your desired application and press the **OK** button to launch the application.

Menu

Icon	Description
X-Sign ()	Edit contents with X-Sign Designer. Refer to X-Sign on page 47 for more information.
MediaPlayer ()	A media player for picture/ music/ video. Refer to Multimedia files on page 40 for more information.
Setting ()	Configure the network and device settings. Refer to Menu operations on page 26 for more information.
Helps ()	Access a QR code page. Scan the QR code to download the user manual.
All Apps ()	Access the apps. Refer to About All Apps on page 49 for more information.
Shortcut ()	Access a list of apps. Select the apps to create a shortcut on the menu page.

X-Sign

Select  to launch **X-Sign**. **X-Sign** is a content player app. Users can edit contents with X-Sign Designer by their PCs or laptops.



After editing the contents, users can import the file to the display through USB flash drive. The contents will then be played automatically.



X-Sign Designer can be downloaded from BenQ website. Please refer to the postcard in the accessory pack for the instructions.

How to change Picture Settings in X-Sign Player

1. Press **MENU** on the remote control to access **X-Sign** settings.
2. To change Picture Settings in **X-Sign** Player, Select **Picture Settings**.

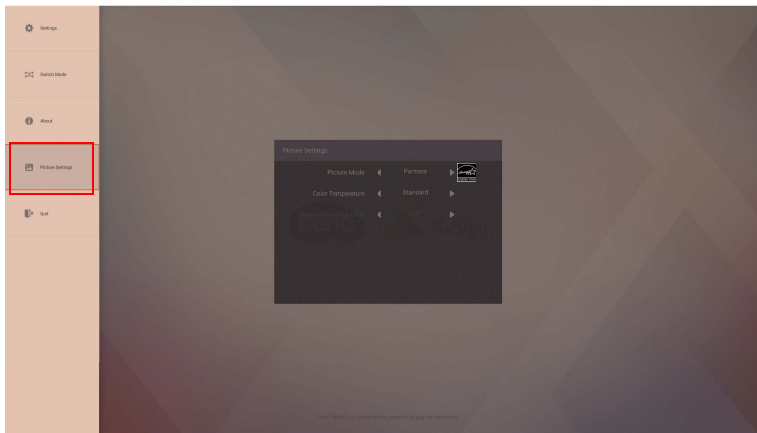

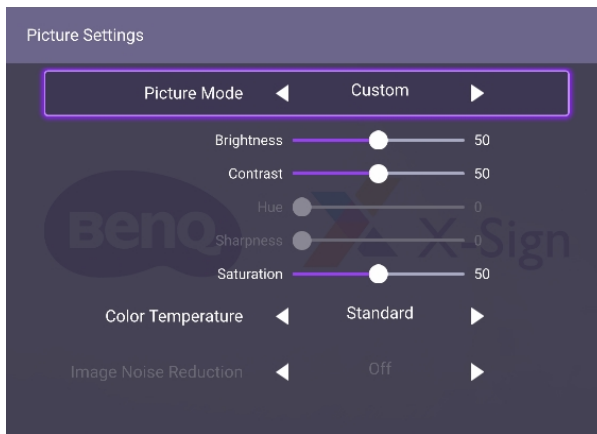
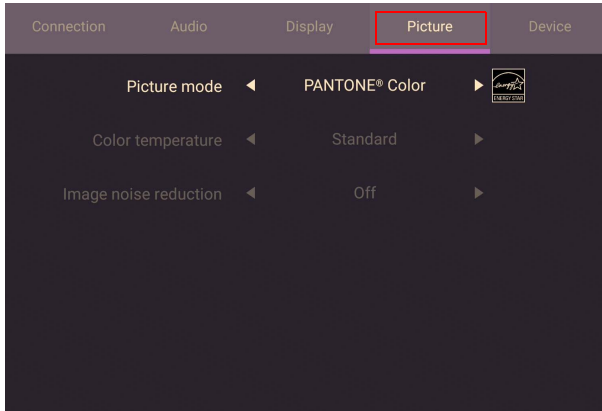



Icon	Description
Picture Mode	Press ◀ / ▶ on the remote control to adjust the picture mode. Options are PANTONE® Color , M-Book , Cinema , Photo , Custom .
Brightness	Press ◀ / ▶ on the remote control to adjust the brightness. This feature only works under Custom in Picture Mode .
Contrast	Press ◀ / ▶ on the remote control to adjust the contrast. This feature only works under Custom in Picture Mode .
Saturation	Press ◀ / ▶ on the remote control to adjust the saturation. This feature only works under Custom in Picture Mode .
Color temperature	Press ◀ / ▶ on the remote control or click a preset color temperature for the image. Options are Cool , Warm , Standard .





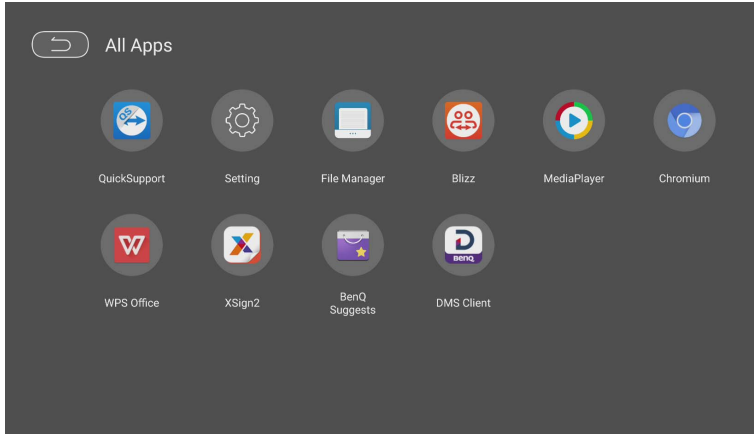





Hue, **Sharpness**, and **Image Noise Reduction** cannot work on Android input.

About All Apps



Select  to launch **All Apps**. Select the application that you want to access.

Application Name	Description
QuickSupport 	A remote control application. You can receive technical remote support for your mobile devices with the app.
File Manager 	Check files. File Manager can only manage files. To play pictures, songs, or videos, use MediaPlayer .
Blizz 	Allow a video conference meeting with any other Blizz users. Refer to Blizz on page 50 for more information.
Chromium 	Access the web pages.
WPS Office 	Read and edit the files in Office formats, including, *.doc, *.txt, *.xls, and *.ppt. Refer to WPS Office on page 51 for more information.
BenQ Suggests 	Show the Android apps suggested by BenQ. Refer to BenQ Suggests on page 53 for more information.
DMS Client 	Device management solution, which allows remote configuration and monitoring.
InstaShare 	Share files stored on the display's internal memory and connected storage devices. InstaShare is not preloaded. You need to download the app via BenQ Suggests. Refer to InstaShare on page 54 for more information.

Blizz

Blizz is a video-conferencing app that is installed in the display by default. It allows you to conveniently conduct video conference meetings with any other **Blizz** users.

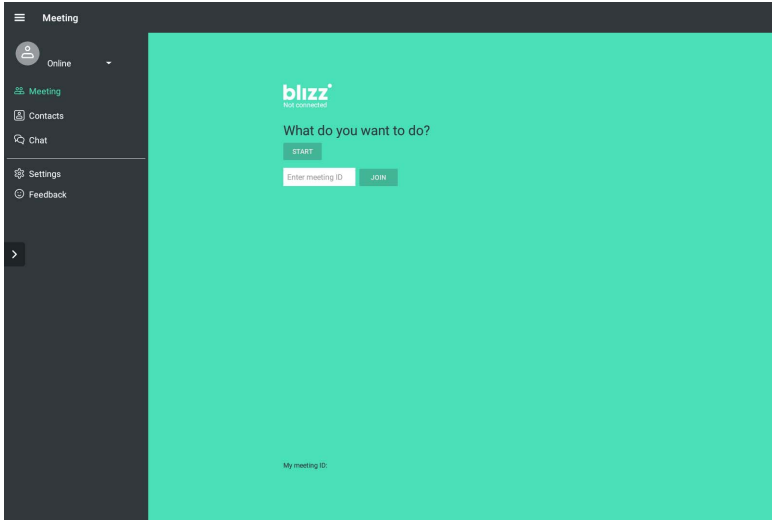

1. On the home screen, select **All Apps >Blizz** ()
2. Select **Sign In** if you want to create a new meeting, select **Join a Meeting** if you want to join an already created meeting.
 - After signing in, create a meeting ID which will be the meeting ID other users will enter to join the meeting.
 - If joining a meeting, enter the meeting ID provided by the creator of the meeting in the Join a Meeting page.

WPS Office

Select  to launch **WPS Office**. With this application, you can open document files including PDFs as well as Microsoft Word, PowerPoint and Excel documents.

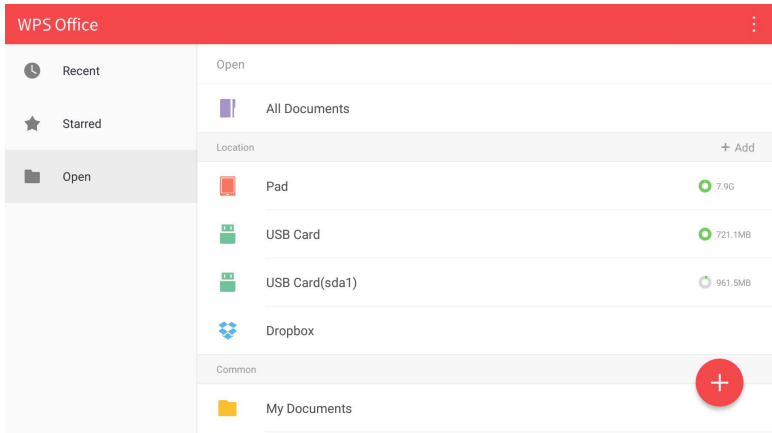

To edit a file with **WPS Office**:

Function	Description
Open	Select to browse and open a file.
Share	Select to share your files through email or other sharing applications.
Manage	Select to edit or manage the document.

1. Select **Open** () on the left panel to browse and open a file located in either the display's internal memory, an external storage device, or cloud storage.
2. Select the function menu on the top panel to access the file format's various functions.



The description is for a PowerPoint file, the function menus for other file formats will vary.

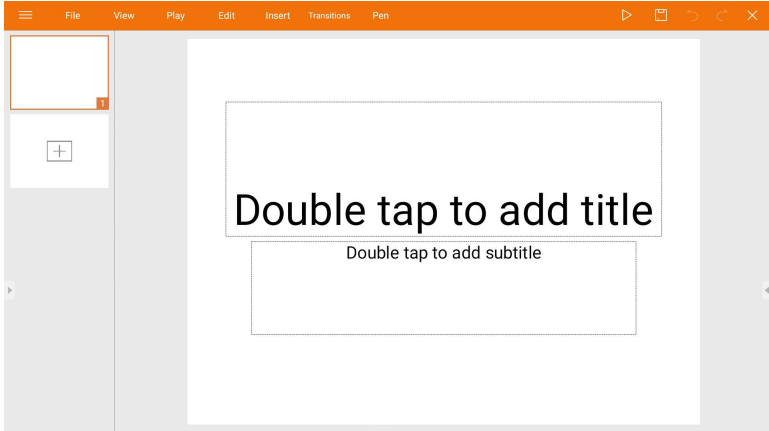

Function	Description
File	Select to open, save, share, print, and manage your presentations.
View	Select to change or edit the presentation views.
Play	Select to start or set up a slide show.
Edit	Select to edit the content or format of the slides.
Insert	Select to insert tables, pictures, charts, comments, video, or audio.
Transitions	Select to apply or adjust the timing of a transition.
Pen	Select to write, draw, paint or sketch to the slides.
Play (▷)	Select to start a slide show.
Save As (📁)	Select to save the presentation file on either the display's internal memory, an external storage device, or cloud storage.
Undo (↶)	Select to undo an action.
Redo (↷)	Select to redo the last action.
Close (✕)	Select to close the presentation file.
Back (←)	Select to return to the previous page.
Next (→)	Select to go to the next page.
Exit (⏏)	Select to exit WPS Office .

Supported Office versions and file formats

Supported Office versions: 97 / 2000 / XP / 2003 / 2007 / 2010

Supported Office software formats:

Office Software	Supported File Formats
Word	wps / wpt / doc / docx / dot / dotx / txt / log / irc / c / cpp / h / asm / s / java / asp / bat / bas / prg / cmd
Excel	et / ett / xls / xlsx / xlt / xlsx / csv / xlsx / xltm
PowerPoint	ppt / pptx

BenQ Suggests

Select  to launch **BenQ Suggests**. With this application, you can view apps suggested by BenQ for download.

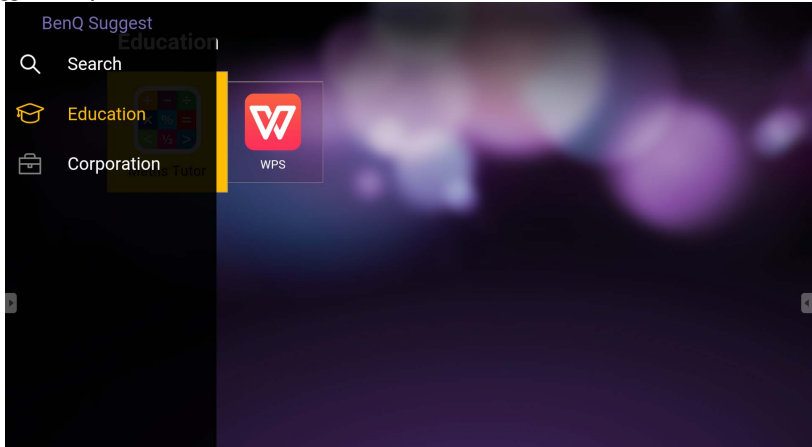

Select the category on the left panel to browse the suggested apps. Select an app from the selected category to view a basic description of the app.

Function	Description
Search (🔍)	Select to search for an app.
Education (🎓)	Select to show the suggested apps in the Education category.
Corporation (💼)	Select to show the suggested apps in the Corporation category.
Exit (⬅️)	Select to close BenQ Suggests .

InstaShare



Select  to launch **InstaShare**. With this application, you can mirror the display's screen on your smartphone or tablet for hands-on annotation and mirror the screen of your smartphone or tablet on the display.

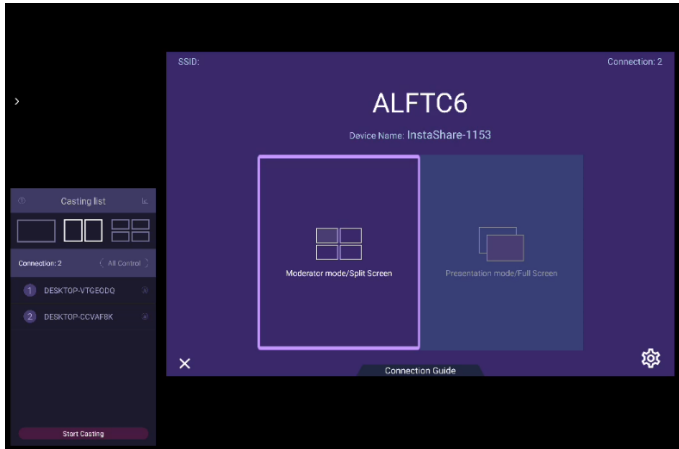

Before launching the application, make sure your display is properly connected to Internet.



To use **InstaShare**:

1. Make sure your mobile device (such as smartphone or tablet) and the display are connected to the same network.
2. Select the connection guide and scan the QR code to download and install the **InstaShare** app on your mobile device.
3. Open the **InstaShare** app on your mobile device, and then click the **InstaShare** ID name that you want to connect to or enter the pairing code.
4. Enter the connect code shown on the upper right corner of the display or you can also find the connection code in **Setting** .
5. Once the mobile device has successfully connected to the display, a confirmation message will appear on the display. Select **Allow** on the display to confirm the connection.
6. Once connected you can:
 - Mirror the display's screen on your mobile device by tapping **Screen Mirroring** on your mobile device.
 - Mirror the device's screen on the display by tapping  on your mobile device.
 - Operate the display by using your mobile device as a remote control.



Once connected, any operations on the display or mobile device will also show up on your mobile device and display.

You can also select **Setting** (⚙️) in the lower right corner of the display to modify the settings for **InstaShare**, such as the **InstaShare** ID name, connect code, or mirroring confirmation message.



Product information

Specifications

Item		Specifications
		SL4302K/SL5502K/SL6502K
LCD panel	Backlight	D-LED
	Panel size	SL4302K: 43" SL5502K: 55" SL6502K: 65"
	Pixel pitch (mm)	SL4302K: 0.245(H) × 0.245(V) SL5502K: 0.315(H) × 0.315(V) SL6502K: 0.372(H) × 0.372(V)
	Frame Rate	60 Hz
	Native resolution (pixels)	UHD 3840 × 2160
	Active Area (mm)	SL4302K: 941.2(H) × 529.4(V) SL5502K: 1209.6(H) × 680.4(V) SL6502K: 1428.48(H) × 803.52(V)
	Brightness (cd/m ²) (typical)	500 nits
	Contrast (typical)	1200:1
	Response time (ms) (typical)	8
	Panel Bit	10 bit
	Aspect Ratio	16:9
Input	Video	VGA x1, HDMI x2 (2.0 x2), DP x1 (1.1/1.2)
	Audio	PC Audio input x1 (3.5mm)
	USB (Type A)	x4 (2.0 x2; 3.0 x2)
	Control	RS232 x1
Output	Audio	Line out x1 (3.5mm)
	External speaker out (L/R)	X
Audio	Audio W (Amp)	10W x2
	Internal speaker	O
Power	Supply	100 - 240 V AC, 50/60 Hz
	Consumption Max.	SL4302K: 125W SL5502K: 148W SL6502K: 270W
	Consumption Standby	< 0.5W

Environment	Operating Temperature	0°C ~ 40°C
	Operating Humidity	20% ~ 80% RH Non-Condensing (without condensation)
	Storage Temperature	-10°C ~ 60°C
	Storage Humidity	10% ~ 90% RH Non-Condensing (without condensation)
	Display Orientation	Landscape & Portrait
Mechanical	Weight (without packing / with packing) (kg)	SL4302K: 17.2kg/24.5kg SL5502K: 26.39kg/31.37kg SL6502K: 35.5kg/48kg
	Dimensions (W x H x D) (mm)	SL4302K: 965.5 x 553.9 x 57.5 SL5502K: 1236.4 x 707.2 x 63.1 SL6502K: 1454.6 x 829.6 x 72 (with handle: 1454.6 x 829.6 x 80)
	Bezel Dimension - T/B/L/R (mm)	SL4302K: 11.7 / 11.7 / 11.7 / 11.7 SL5502K: 11.8 / 11.8 / 11.8 / 11.8 SL6502K: 12.6 / 12.6 / 12.6 / 12.6
Feature	Image setting	O
	Picture mode	O
	Sharpness enhancement	O
	10-bit color processing	O
	Source / volume control	O
	HDMI-HDCP	2.0
	Internal Temperature Sensor	O
	CEC Control	O
	FW Update	USB/OTA
	Power Mode	O
	Boot Source	O



Specifications and functions are subject to change without notice.

Item		SL4302K/SL5502K/SL6502K
System	System Memory	4 GB
	Storage	32 GB
	OS	Android 8.0



- OS: This Android 8.0 operating system is not standard Android, so access to Google Play™ is not available. APK cannot be installed in the default location. Without management permission, installing function won't work. There is no guarantee that the self-installed APK can function normally.
- Storage: Content storage may vary by the product supplied for your region. Pre-installed system and apps may take up some space.

Dimensions

SL4302K

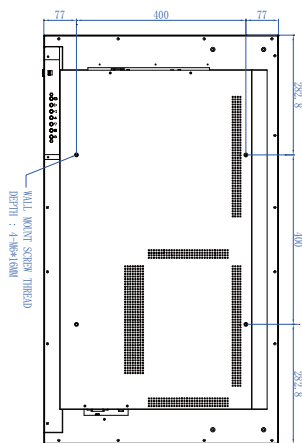
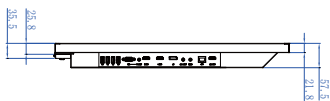
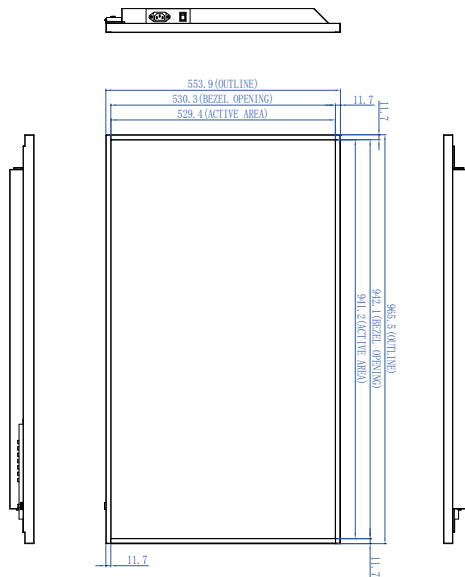

Unit: mm

SL5502K

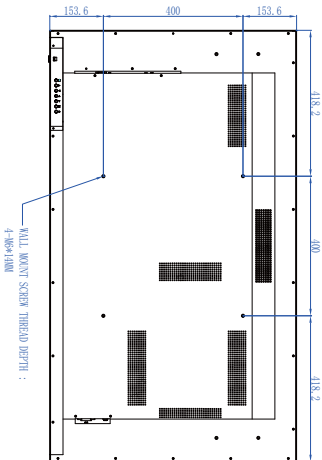
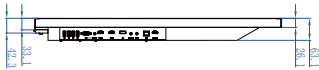
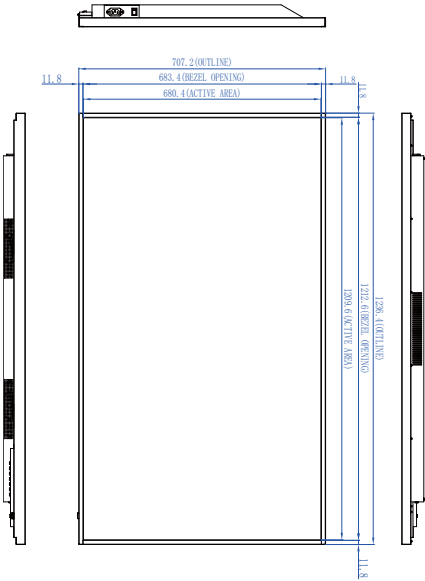

Unit: mm

SL6502K

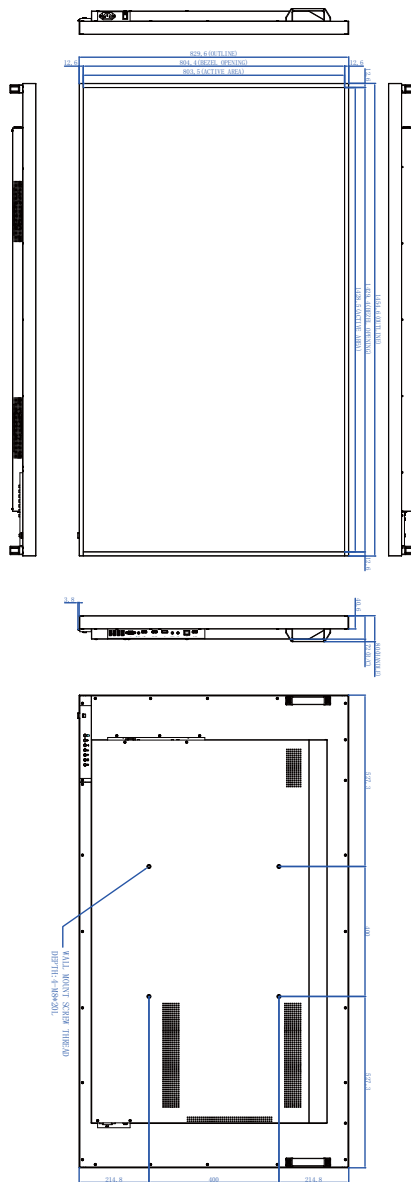

Unit: mm

Supported input signal resolution

Resolution	Input source		
	VGA	EDID 2.0	DP
640 x 480 @ 60Hz	○	○	○
720 x 400 @ 70Hz	○	○	○
800 x 600 @ 60Hz	○	○	○
1024 x 768 @ 60Hz	○	○	○
1280 x 768 @ 60Hz	○	○	○
1280 x 960 @ 60Hz	○	○	○
1280 x 1024 @ 60Hz	○	○	○
1366 x 768 @ 60Hz	○	○	○
1440 x 900 @ 60Hz	○	○	○
1680 x 1050 @ 60Hz	○	○	○
1920 x 1080 @ 60Hz	○	○	○
3840 x 2160 @ 24Hz		○	○
3840 x 2160 @ 25Hz		○	○
3840 x 2160 @ 30Hz		○	○
3840 x 2160 @ 50Hz		○	○
3840 x 2160 @ 60Hz		○	○
480i (60Hz)		○	
480p (60Hz)		○	
576i (50Hz)		○	
576p (50Hz)		○	
720p (50Hz)		○	○
720p (60Hz)		○	○
1080i (50Hz)		○	○
1080i (60Hz)		○	○
1080p (50Hz)		○	○
1080p (60Hz)		○	○



- : supported
- Blank: not supported

Troubleshooting

Problem	Solution
No picture	<p>Check the following:</p> <ul style="list-style-type: none"> • Is the display turned on? Check the power indicator of the display. • Is the signal source device turned on? Turn on the device and try again. • Are there any loose cable connections? Make sure that all cables are connected firmly. • Have you chosen an unsupported output resolution on the computer? Refer to Supported input signal resolution on page 61 to select a supported resolution and try again. • Have you chosen an unsupported output resolution on the DVD or Blu-ray disc player? Refer to Supported input signal resolution on page 61 to select a supported resolution and try again.
No sound	<p>Check the following:</p> <ul style="list-style-type: none"> • Have you turned on the mute function on the display or the input source device? Turn off the mute function or increase the audio volume level and try again. • Are there any loose cable connections? Make sure that all cables are connected firmly.
The computer input image looks strange.	<ul style="list-style-type: none"> • Have you chosen an unsupported output resolution on the computer? Refer to Supported input signal resolution on page 61 to select a supported resolution and try again. • Use the Auto function to let the display automatically optimize the display of computer image. Refer to Display settings on page 36 for more information. • If the result of the Auto Tune function is not satisfactory, use the Phase, Horizontal Position, and Vertical Position functions to manually adjust the image.
The control panel buttons do not work.	<p>Have you locked the control panel buttons? Unlock the buttons and try again.</p>

<p>The remote control does not work.</p>	<ul style="list-style-type: none">• Have you locked the remote control function? Unlock the function and try again.• Check for incorrect battery orientation.• Check for dead batteries.• Check your distance and angle from the display.• Check whether remote control is properly being pointed at the display's remote control sensor window.• Check for any obstacle between the remote control and the remote control sensor window.• Check that the remote control sensor window is not under strong fluorescent lighting, or in direct sunlight.• Check for any devices (computer or personal digital assistant, PDA) nearby that transmit infrared signals which may cause interference to signal transmission between the remote control and the display. Turn off the infrared function of these devices.
--	--