

B&G

V60 & H60
Fixed Mount VHF &
Wireless Handset
User Guide

ENGLISH



Preface

Disclaimer

As Navico is continuously improving this product, we retain the right to make changes to the product at any time which may not be reflected in this version of the manual. Please contact your nearest distributor if you require any further assistance.

It is the owner's sole responsibility to install and use the equipment in a manner that is legal and will not cause accidents, personal injury or property damage. The user of this product is solely responsible for observing safe boating practices.

NAVICO HOLDING AS AND ITS SUBSIDIARIES, BRANCHES AND AFFILIATES DISCLAIM ALL LIABILITY FOR ANY USE OF THIS PRODUCT IN A WAY THAT MAY CAUSE ACCIDENTS, DAMAGE OR THAT MAY VIOLATE THE LAW.

Governing Language: This statement, any instruction manuals, user guides and other information relating to the product (Documentation) may be translated to, or has been translated from, another language (Translation). In the event of any conflict between any Translation of the Documentation, the English language version of the Documentation will be the official version of the Documentation.

This manual represents the product as at the time of printing. Navico Holding AS and its subsidiaries, branches and affiliates reserve the right to make changes to specifications without notice.

Copyright

Copyright © 2019 Navico Holding AS.

Warranty

The warranty card is supplied as a separate document.

In case of any queries, refer to the brand website of your unit or system: www.bandg.com

Licensing Information

- The user is advised to check the radio operating licensing requirements of your country before using this VHF radio. The operator is solely responsible for observing proper radio installation and usage practices.
- In some regions/countries, a Radio Operator's license is required

and it is your responsibility to determine whether such a license is required before operating the radio.

- The frequencies used by this radio are reserved for Maritime use only and those frequencies must be included on your Radio Operator's license.
- A valid USER MMSI number must be entered into this radio before DSC functions can be used. You must apply for an MMSI number which is usually obtained from the same authority that issues the radio operator's license. Contact the appropriate licensing authority in your country. If you're unsure who to contact, consult your B&G dealer.
- A valid ATIS ID number must be entered into this radio before ATIS functions can be used. An ATIS ID number is issued by Ofcom when you add one or more pieces of ATIS equipment to your Ship Radio Licence.

Important information

- This B&G DSC VHF radio is designed to generate a digital maritime distress call to facilitate search and rescue. To be effective as a safety device, this radio must be used only within the geographic range of a shore-based VHF marine Channel 70 distress and safety watch system. The geographic range may vary but under normal conditions is approximately 20 nautical miles.
- This radio can be configured to operate in your region/country of operation. The user can select the region/country of operation during the initial setup of the radio. This is a once-only operation. Should you require to change the region/country, consult your B&G dealer.

Regulatory Compliance Statements

European Union

Hereby, Navico Holding AS declares that the radio equipment type V60 and H60 are in compliance with Directive 2014/53/EU (RED). The full text of the EU declaration of conformity is available at the following internet address: www.bandg.com

EU RF exposure compliance notice for Fixed Mount VHF

To be protected against all verified adverse effects, the separation distance of at least 2 m must be maintained between the antenna of the radio having max. 6 dBi antenna and all persons.

Countries of intended use in the EU

AT - Austria	HU - Hungary	PL - Poland
BE - Belgium	IS - Iceland	PT - Portugal
BG - Bulgaria	IE - Ireland	RO - Romania
CY - Cyprus	IT - Italy	SK - Slovak Republic
CZ - Czech Republic	LV - Latvia	SI - Slovenia
DK - Denmark	LI - Liechtenstein	ES - Spain
EE - Estonia	LT - Lithuania	SE - Sweden
FI - Finland	LU - Luxembourg	CH - Switzerland
FR - France	MT - Malta	TR - Turkey
DE - Germany	NL - Netherlands	UK - United Kingdom
GR - Greece	NO - Norway	

United States

Part 15 of the FCC Rules. Operation is subject to the following two conditions: (1) this device may not cause harmful interference, and (2) this device must accept any interference received, including interference that may cause undesired operation.

Warning

The user is cautioned that any changes or modifications not expressly approved by the party responsible for compliance could void the user's authority to operate the equipment.

RF Emissions notice

This equipment complies with FCC radiation exposure limits set forth for an uncontrolled environment. This device's antenna must be installed in accordance with provided instructions; and it must be operated with minimum 2 m spacing between the antennas and all person's body (excluding extremities of hands, wrist and feet) during operation. Further, this transmitter must not be co-located or operated in conjunction with any other antenna or transmitter.

- **Note:** This equipment has been tested and found to comply with the limits for a Class B digital device, pursuant to Part 15 of the FCC Rules. This equipment generates, uses and can radiate radio frequency energy and, if not installed and used in accordance with the instructions, may cause harmful interference to radio communications. However, there is no guarantee that the interference will not occur in a particular installation. If this equipment does cause harmful interference to radio or television reception, which can

be determined by turning the equipment off and on, the user is encouraged to try to correct the interference by one or more of the following measures:

- Reorient or relocate the receiving antenna.
- Increase the separation between the equipment and receiver.
- Connect the equipment into an outlet on a circuit different from that of the receiver is connected.
- Consult the dealer or an experienced technician for help.

FCC Part 18 Compliance Statement for Cradle Charger (BC-12)

This device complies with Part 18 of the FCC Rules.

CAUTION: Changes or modifications not expressly approved by the party responsible for compliance could void the user's authority to operate the product.

→ **Note:** This equipment has been tested and found to comply with the limits for a wireless power transfer, pursuant to Part 18 of the FCC Rules. These limits are designed to provide reasonable protection against harmful interference in a residential installation. This equipment generates, uses and can radiate radio frequency energy and, if not installed and used in accordance with the instructions, may cause harmful interference to radio communications. However, there is no guarantee that interference will not occur in a particular installation. If this equipment does cause harmful interference to radio or television reception, which can be determined by turning the equipment off and on, the user is encouraged to try to correct the interference by one or more of the following measures:

- Reorient or relocate the receiving antenna.
- Increase the separation between the equipment and receiver.
- Connect the equipment into an outlet on a circuit different from that of the receiver is connected.
- Consult the dealer or an experienced technician for help.

FCC RF exposure compliance for Cradle Charger (BC-12)

This device complies with FCC radiation exposure limits set forth for an uncontrolled environment. This transmitter must not be co-located or operating in conjunction with any other antenna or transmitter.

Canada

This device complies with CAN ICES-3(B)/NMB-3(B) and contains license-exempt transmitter(s)/receiver(s) that comply with Innovation, Science and Economic Development Canada's license-exempt RSS(s). Operation is subject to the following two conditions:

1. This device may not cause interference.
2. This device must accept any interference, including interference that may cause undesired operation of the device.

L'émetteur/récepteur exempt de licence contenu dans le présent appareil est conforme aux CNR d'Innovation, Sciences et Développement économique Canada applicables aux appareils radio exempts de licence. L'exploitation est autorisée aux deux conditions suivantes:

1. L'appareil ne doit pas produire de brouillage.
2. L'appareil doit accepter tout brouillage radioélectrique subi, même si le brouillage est susceptible d'en compromettre le fonctionnement.

Industry Canada Statement

This equipment complies with IC RSS-102 radiation exposure limits set forth for an uncontrolled environment. This transmitter must not be co-located or operating in conjunction with any other antenna or transmitter. This equipment should be installed and operated with minimum distance 2 m between the radiator and your body.

Cet équipement est conforme aux limites d'exposition aux radiations IC CNR-102 établies pour un environnement non contrôlé. Cet émetteur ne doit pas être situé ou fonctionner conjointement avec une autre antenne ou un autre émetteur. Cet équipement doit être installé et utilisé avec une distance minimale de 2 m entre le radiateur et votre corps.

Under Industry Canada regulations, this radio transmitter may only operate using an antenna of a type and maximum (or lesser) gain approved for the transmitter by Industry Canada. To reduce potential radio interference to other users, the antenna type and its gain should be so chosen that the equivalent isotropically radiated power (e.i.r.p.) is not more than that necessary for successful communication.

Conformément à la réglementation d'Industrie Canada, le présent émetteur radio peut fonctionner avec une antenne d'un type et d'un gain maximal (ou inférieur) approuvé pour l'émetteur par Industrie Canada. Dans le but de réduire les risques de brouillage

radioélectrique à l'intention des autres utilisateurs, il faut choisir le type d'antenne et son gain de sorte que la puissance isotrope rayonnée équivalente (p.i.r.e.) ne dépasse pas l'intensité nécessaire à l'établissement d'une communication satisfaisante.

This radio transmitter has been approved by Industry Canada to operate with the antenna types listed below with the maximum permissible gain and required antenna impedance for each antenna type indicated. Antenna types not included in this list, having a gain greater than the maximum gain indicated for that type, are strictly prohibited for use with this device.

Le présent émetteur radio a été approuvé par Industrie Canada pour fonctionner avec les types d'antenne énumérés ci-dessous et ayant un gain admissible maximal et l'impédance requise pour chaque type d'antenne. Les types d'antenne non inclus dans cette liste, ou dont le gain est supérieur au gain maximal indiqué, sont strictement interdits pour l'exploitation de l'émetteur.

IC RF exposure compliance for H60 Wireless Handset and Cradle Charger (BC-12)

This equipment complies with IC RSS-102 radiation exposure limits set forth for an uncontrolled environment. This transmitter must not be co-located or operating in conjunction with any other antenna or transmitter.

Cet équipement est conforme aux limites d'exposition aux radiations IC CNR-102 établies pour un environnement non contrôlé. Cet émetteur ne doit pas être situé ou fonctionner conjointement avec une autre antenne ou un autre émetteur.

Australia & New Zealand

Complies with the requirements of level 2 devices of the Radiocommunications (Electromagnetic Compatibility) standard 2017 and Radiocommunications (VHF Radiotelephone Equipment – Maritime Mobile Service) Standard 2014.

Trademarks

B&G® and Navico® are registered trademarks of Navico.

NMEA® and NMEA 2000® are registered trademarks of the National Marine Electronics Association.

DSC (Digital Selective Calling)

Digital Selective Calling offers significant safety and convenience advantages over older VHF radios without this functionality.

- A valid USER MMSI must be entered into this radio before DSC functions can be used.
- Many countries do not have radio repeaters that support DSC message relaying. However DSC can still be useful for direct ship-to-ship communication, where the other vessel is also equipped with a DSC capable radio.
- DSC distress calls generated by this radio are limited to the same range restrictions that apply to regular VHF transmissions. The vessel sending a distress can only rely upon DSC if within range of a GMDSS Coast Radio Station. Typical VHF range may be about 20NM, though this varies greatly depending upon installation, antenna type, meteorological conditions, etc.

ATIS (Automatic Transmitter Identification System)

- ATIS is required for vessels making VHF transmissions whilst on the inland waterways of the Regional Arrangement Concerning the Radiotelephone Service on Inland Waterways (RAINWAT) signatory countries.
- RAINWAT is an agreement to implement common principles and rules for the safe carriage of people and goods on Inland Waterways.
- The signatory countries are: Austria, Belgium, Bulgaria, Croatia, the Czech Republic, France, Germany, Hungary, Luxembourg, Moldova, Montenegro, the Netherlands, Poland, Romania, Serbia, the Slovak Republic and Switzerland.
- Where a VHF is required on the inland waterways of the signatory countries, this must be capable of ATIS transmissions, and have the feature activated.
- The use of ATIS is prohibited outside the European inland waterways covered by the Basel Agreement.

MMSI and ATIS ID

The user MMSI (Marine Mobile Service Identity) is a unique nine digit number. It is used on marine transceivers that are capable of using DSC (Digital Selective Calling).

- An MMSI remains with a vessel, even if the vessel is sold on.
- An MMSI has 9 numeric digits (xxxxxxxx). Your MMSI must not commence with a '0'.
- A Group Call ID begins with '0' followed by 8 numeric digits (0xxxxxxxx).
- A Coast Station MMSI begins with 00 followed by 7 numeric digits (00xxxxxxxx).
- By law, you are not able to change your MMSI once it is entered into the radio. This is why there is the confirmation screen when entering the MMSI. If you need to have the MMSI in the radio changed, the radio must be taken back to your B&G dealer.
- An ATIS ID is only required in certain EU countries when navigating some inland waterways. It is usually a different number to your MMSI.

About this manual

This manual is a reference guide for installing and operating a V60 VHF radio. Important text that requires special attention from the reader is emphasized as follows:

- **Note:** Used to draw the reader's attention to a comment or some important information.
-  **Warning:** *Used when it is necessary to warn personnel that they should proceed carefully to prevent risk of injury and/or damage to equipment/personnel.*

Contents

12 General Information

- 13 How to display and navigate menus
- 16 Key functions

22 Radio menus

- 22 Scan
- 23 Watch
- 24 Display
- 25 Radio setup
- 29 DSC setup
- 31 AIS setup
- 32 Alarms
- 33 Wireless handset
- 34 Reset

35 DSC call menu

- 35 DSC calls
- 38 Track buddy
- 39 Contacts

40 AIS menu

- 40 About AIS
- 41 Using the AIS receiver
- 41 AIS information and display

44 Hailer / Fog Horn / Intercom

- 44 Using the Hailer (PA) function
- 45 Using the Fog Horn
- 45 Using the Intercom facility

46 Wireless handset

- 46 Using the wireless handset
- 46 Using the Intercom facility

47	My channels
48	Shortcuts
49	Installation
49	What's in the box
50	Installation options
50	Selecting a suitable mounting location
56	Cradle charger (BC-12)
57	First startup configuration
59	Specifications
64	Channel charts
64	EU and INTERNATIONAL channel chart
72	USA channel chart
74	CANADA channel chart
77	Dimensional drawings
77	V60 fixed mount VHF
78	V60 hand mic
79	Handset Cradle Charger (BC-12)
80	H60 wireless handset
81	NMEA 2000 compliant PGN list

1

General Information

Your V60 provides the following useful features:

- AIS dual channel receiver to receive and display AIS targets
- Ability to communicate with up to 2 optional wireless handsets (H60)
- 6-key removable handset microphone with built-in speaker. Can be front or rear connected to the radio with optional extension cable
- Built-in GPS receiver and antenna with connection for optional external GPS antenna
- Intercom, Fog Horn and Hailer functions
- NAV/MOB key to display dedicated navigation or Man Over Board screens
- TRI key to select DUAL/TRI scan
- Dedicated Wx (Weather) key
- Favourite channels list to build your list of commonly used channels
- Shortcuts list to build your list of commonly used radio features
- Access to all currently-available marine VHF channel banks (USA, Canada, International) including weather channels where available (country mode dependant)
- Dedicated CH16/9 key for quick access to the priority (international distress) channel
- DSC (Digital Selective Calling) capability that meets Global DSC Class D Standards
- DISTRESS call button to automatically transmit the MMSI and position until an acknowledgement is received
- ATIS facility for inland waterways (EU country mode)
- With DSC Auto-Switch disable and DSC Test function
- Contacts list that stores up to 50 names with MMSI numbers
- MMSI storage for one favourite group
- Group Call and All Ships Call facility
- Weather alert facility where available (US country mode)
- Prominent channel display
- Adjustable contrast settings for the LCD
- Adjustable keypad backlighting for easy night-time use
- Waterproof and submersible to comply with IPx7
- Choice of High (25 W) or Low (1 W) transmission power
- Powerful 4 W external audio output
- GPS latitude and longitude (LL) and time display (with valid GPS source)
- LL position polling information.

How to display and navigate menus

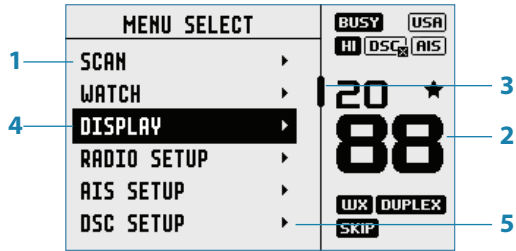

1. Split screen display – showing Main menu.
 2. Split screen display – showing Channel screen.
 3. Scroll bar indicates additional options above and below displayed text.
 4. Current menu item is selected using the channel knob.
 5. Arrow indicates additional sub-menu items in this menu option.
- **Note:** Press the X button to step backwards to the previous menu page, or exit the menus completely.

Entry of alphanumeric data

Rotate the channel knob to scroll through the alphanumeric characters.

Press channel knob, to select and step to the next character.





























To step backwards, press the MENU button. Press X to cancel entry and return to previous menu.

LCD symbols and meanings

When the V60 starts up it momentarily displays the brand, model, country mode, software version, and MMSI.



During normal operation, the following icons may be displayed on the screen depending on setup:

Symbol	Meaning
	Radio is transmitting
	Receiver busy with incoming signal
	Low Transmit power selected (1W)
	High Transmit power selected (25W)
	Current channel is Duplex (off when Simplex)
	Current channel is receive only
	Local mode enabled (used when in areas of high radio traffic, i.e. inner harbour)
	Channel is saved as a favourite
	Channel will be skipped during a scan
	Weather channel stored by user (EU & INT country modes only)
	Channel bank is set to USA
	Channel bank is set to International. (Channels available depends on selected country mode)
	Channel bank is set to Canada
	ATIS functionality is enabled (EU country mode only - must be enabled when in European inland waterways)
	DSC functionality is enabled
	DSC functionality is enabled, auto switch is turned off
	AIS function is enabled
	Internal GPS is enabled, with valid 3D fix
	Internal GPS is enabled, no fix
	External GPS is enabled, with valid 3D fix
	External GPS is enabled, no fix
	Weather alert enabled (USA/CAN only)
	Missed DSC call
	Low Battery (vessel) warning (activates at 10.5 V)
	Battery level (wireless handset)
	Track your Buddy feature is active
	Current channel is selected as the Watch channel
	GPS simulator is active

A typical display:

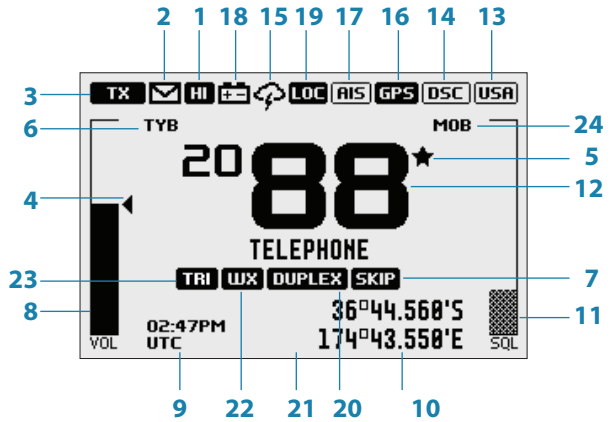

1. Channel is set to high power transmit
2. Missed call in the DSC call log
3. Channel is busy
4. Volume is under active control (solid black indicates control is active)
5. Current channel saved in 'My Channels'
6. Track your buddy is enabled
7. Current channel will be skipped during a scan
8. Volume level indicator
9. Time (derived from GPS) - UTC offset is applied
10. Latitude/Longitude
11. Squelch level indicator (greyed out means control is not active)
12. Channel number (2 or 4 digits)
13. The USA channel bank is active
14. DSC functionality is enabled, but autoswitch is off
15. Weather alert function is enabled
16. Internal GPS is enabled, with 3D fix
17. AIS receiver is enabled
18. Low vessel voltage alert
19. Sensitivity mode is set to LOCAL
20. Current channel is Duplex
21. GPS Simulate mode is active
22. Current channel is set as the Weather channel (use Wx key to select)
23. Current channel is set as the Watch channel (use TRI key to select)
24. MOB waypoint is active.

Key functions

The following describes the direct functions of the keys/knobs. Where necessary, additional detail on any menus accessed by keys is covered in following chapters.

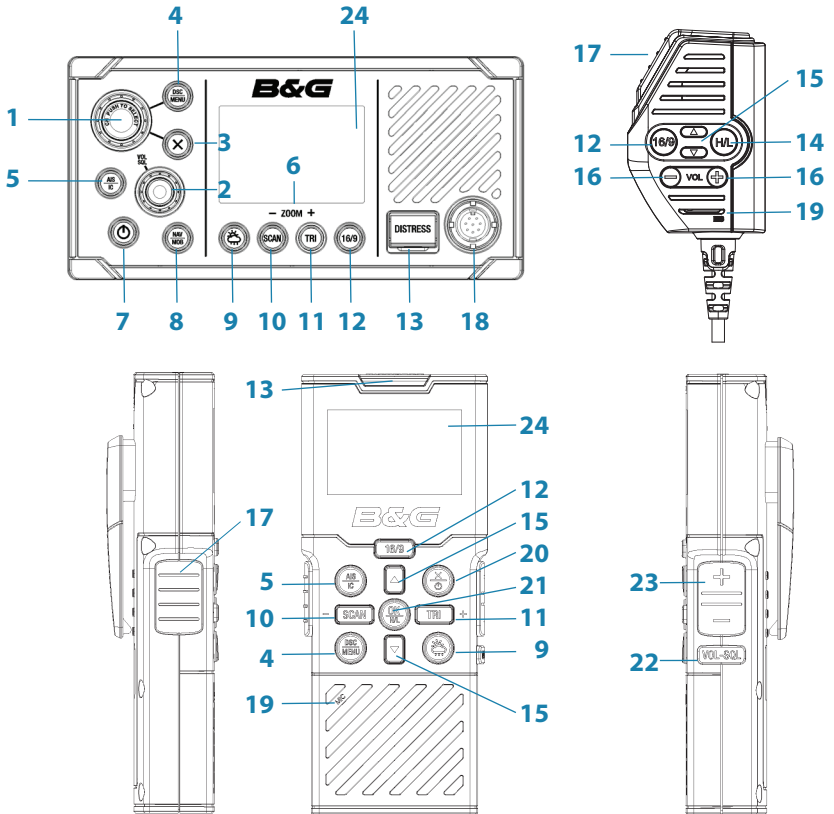

1. Channel knob / Press to Select

Turn knob for channel selection, menu scrolling, alphanumeric entry, and fine adjustment of backlight level (dependent on active menu).

Short press to make selections in menus.

Long press to open MY CHANNELS.

2. VOL / SQL

Volume and Squelch level.

Short press knob to select which control to adjust. Which is currently selected is indicated by a small triangular arrow above the level bar for each option. **Turning** the knob clockwise increases setting, anti-clockwise decreases it. Volume control is common to

internal and external speaker.
Long press to open SHORTCUTS.

3. X (EXIT)

Press X when navigating menus, to clear incorrect entries, to exit from a menu without saving changes, and to back up to the previous screen.

4. DSC CALL / MENU SELECT (*Radio and wireless handset*)

Short press to enter the DSC Call Menu and make DSC calls.
Long press to open the MENU SELECT page.

5. AIS / IC (*Radio and wireless handset*)

Short press to enter the AIS (Automatic Identification System) mode. See page 31 for AIS setup or page 31 for AIS functionality.
Long press to enter Intercom / Hailer / Fog Horn mode. See page 46 for Intercom functionality and page 44 for Fog Horn / Hailer functionality.

6. Zoom keys

Used in AIS mode.
Press TRI (zoom in) or **SCAN** (zoom out) to change the scale of the AIS plotter. The scales available are: 1, 2, 4, 8, 16, 32 nm.

7. Power / Backlight

Short Press to adjust backlight level sequentially.
Repeated short press of the power button will step through large backlight adjustments. The Channel knob can be used to make finer adjustments.
Long press to turn radio on or off.

8. NAV / MOB

Short press to enter the NAV (Navigation) mode. The screen will change to navigation mode displaying the vessel's current SOG and COG.



Press X to exit NAV mode and return to normal radio operation mode.

Long press to mark the current location with a Man-Over-Board (MOB) waypoint. The screen will change to MOB navigation mode to

help navigate back to the MOB location:



DST (Distance to MOB waypoint).

STEER (Bearing to MOB waypoint) and direction indicators using ◀ for turn to port, ■ for straight ahead and ▶ for turn to stbd (starboard).

Long press **X** to exit MOB navigation. A pop up screen will appear with 2 choices:

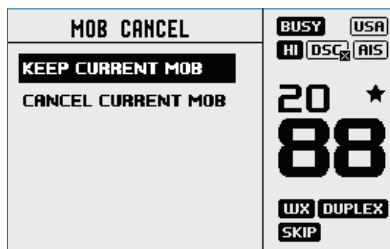

1. KEEP CURRENT MOB: to return to normal operation mode without cancelling MOB navigation.

2. CANCEL CURRENT MOB: to cancel current MOB navigation and return to normal radio operation mode.

Or, short press **X** to close the pop up and resume current MOB navigation.

Long press NAV/MOB to set a new MOB waypoint at the current location. A pop up screen will appear with 2 choices:

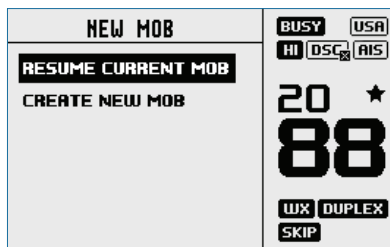

1. RESUME CURRENT MOB: to close pop up and resume current MOB navigation.

2. CREATE NEW MOB: to cancel current MOB navigation and create a new Man-Over-Board (MOB) waypoint at the current location. Or, **short press X** to close the pop up and resume current MOB navigation.

→ **Note:** Long press TRI and SCAN keys on the wireless handset to set a MOB waypoint.

9. **Weather Channel** (*Radio and wireless handset*)

Short press (US/CAN country mode): press to hear the most recently selected NOAA/Canadian weather station.

For non US/CAN country modes, changes channel to user programmed choice.

Long press (non US/CAN country mode): to store current channel as the weather channel.

10. **SCAN / ZOOM-** (*Radio and wireless handset*)

- Normal radio mode:

Short press to enter ALL SCAN mode.

ALL SCAN sequentially scans all channels for activity.

When a signal is received, scanning stops at that channel and the BUSY icon appears on the screen. If the signal ceases for more than 5 seconds, the scan automatically resumes.

Turn the channel knob to temporarily skip over (lock out) a busy channel and resume the scan. The direction turned determines if the scan goes up or down the channel numbers (ie 'forward' or 'reverse'). If it is still busy when the scan completes a full cycle, it will stop again at this channel. Note that it is not possible to skip over the priority channel.

Press ENT to permanently skip over the channel. The SKIP icon will show on the LCD for this channel.

To cancel a skipped channel, select the channel while in normal mode (non-scan mode) then press the ENT key - the SKIP icon will disappear. Repowering the radio also restores all skipped channels. Press SCAN or X while scanning is active to stop at the current channel and return to normal operation.

Long press SCAN from normal operation to enter the SCAN menu.

- AIS mode:

Short press to increase (zoom out) the scale of the AIS plotter out one range at a time. The scales available are: 1, 2, 4, 8, 16, 32 nm.

11. **TRI / ZOOM+** (*Radio and wireless handset*)

- Normal radio mode:

Short press to start DUAL WATCH or TRI WATCH (if 'watch' channel set).

Long press to set the current channel as the watch channel. When a short press is made on the TRI key, the radio will either switch to DUAL or TRI watch mode depending on whether a watch channel has been setup. Without a watch channel the radio will go to DUAL WATCH, where the channels 'watched' are the current channel and the priority channel (the distress channel, CH16 for most countries). With a watch channel selected, TRI WATCH is enabled, where the channels 'watched' are the current channel the 'watch' channel, and the priority channel (the distress channel, CH16 for most countries). If the radio is set to 'Country: USA', two priority channels are watched - Channel 9 and Channel 16.

- AIS mode:

Short press to reduce (zoom in) the scale of the AIS plotter out one range at a time. The scales available are: 1, 2, 4, 8, 16, 32 nm.

12. 16 / 9 (Radio, handset mic and wireless handset)

Short press to change to priority channel. Press again to return to original channel. The default Priority Channel is CH16.

For US country mode: Long press to make Channel 09 the priority channel.

13. DISTRESS (Radio and wireless handset)

Short press to start a distress call, where the nature of distress can be selected from a list.

Long press the distress button to initiate an 'undesignated' distress call.

The Distress call is broadcast to all DSC equipped radios, so will create an alarm on every DSC radio within range.

If position information is available it will be included in the transmission.

14. H/L (Transmission power) (Handset mic only)

Press to toggle between high (25 W) or low (1 W) transmission power for the entire channel bank. The HI or LO selection is shown on the LCD.

Some channels allow only low power transmissions. Error beeps will sound if attempting to change the transmission power while on one of these channels.

Some channels allow only low power transmissions initially, but can be overridden to high power by **pressing (and holding) H/L after depressing PTT**. Keep the H/L button pressed down after releasing the PTT button, if wanting to transmit again on high power.

- 15. Channel change** (*Handset mic and wireless handset*)
Short press (△) goes up one channel, or (▽) goes down one channel. Holding either key will, after a short delay, step rapidly through the channels.
- 16. VOL +/- (Volume)** (*Handset mic only*)
Change the volume on the handset microphone.
Short press (+) increases the volume, or (-) decreases the volume.
- 17. PTT (Push-to-talk)** (*Handset mic and wireless handset*)
Press button to transmit. Only depress for duration of message to be broadcast. Radio can't receive while it is transmitting.
- 18.** Handset microphone (front) connection. Plug in the removable handset microphone. Alternatively, it can be connected to the rear of the radio.
- 19. MIC (Microphone)** (*Handset mic and wireless handset*)
The microphone can be connected to the front MIC connector or rear MIC connector. An optional 5 m or 10 m extension cable is available for mounting the microphone in a different location.
- 20. POWER / EXIT** (*Wireless handset*)
Short press to EXIT when navigating menus, to clear incorrect entries, to exit from a menu without saving changes, and to back up to the previous screen.
Long press to turn radio on or off.
- 21. OK / H/L** (*Wireless handset*)
Short press to make selections in menus.
Long press to change transmission power - see item 14.
- 22. VOL / SQL** (*Wireless handset*)
Short press to select which control (Volume and Squelch) to adjust.
Use the + & - buttons to adjust.
- 23. +/-** (*Wireless handset*)
Short press to adjust the selected control (Volume and Squelch).
- 24. LCD (Display)** (*Radio and wireless handset*)

2

Radio menus

A long press of the MENU button opens MENU SELECT page. The following shows the menu structure (top and 2nd level only):

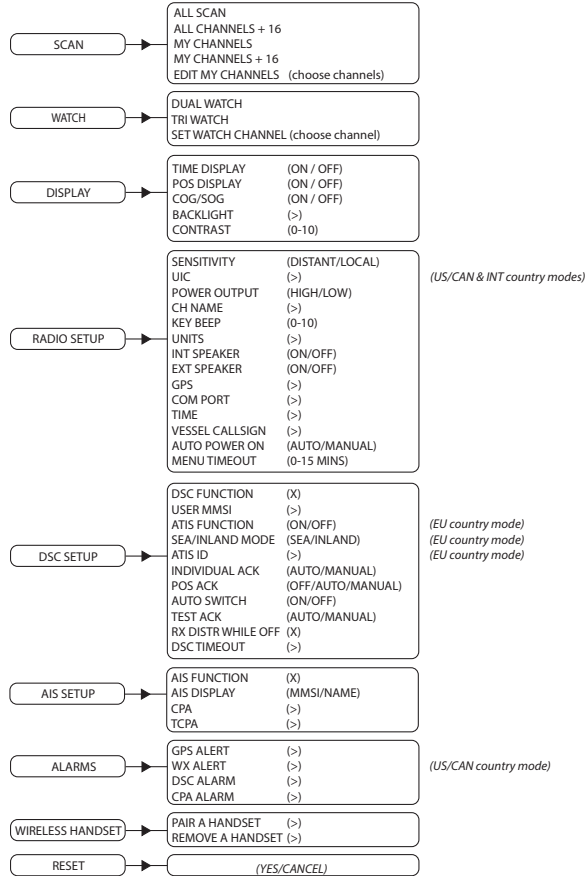

Key:

(>) further menu options

(X) toggle selection. 'X' means option enabled.

Scan

This menu is for choosing a scan mode to enable, as well as selection of the channels scanned per the MY CHANNELS list.

➔ **Note:** Scanning is not available if ATIS mode is turned on.

All scan

Scans all channels cyclically.

All channels + 16

Scans all channels cyclically, but checks the priority channel after every channel step.

My channels

Scan all channels selected in EDIT MY CHANNELS.

My channels + 16

Scans all channels selected in EDIT MY CHANNELS, while also checking the priority channel after every channel step.

Edit my channels

Allows creation of a custom list of channels - used in a MY CHANNELS scan.

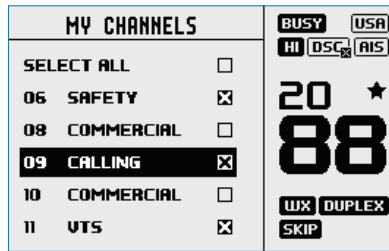

Watch

This menu is for choosing a watch mode to enable, as well as selection of the watch channel. Watch modes can be thought of as a channel scan on a subset of channels, where scanned channels are 'listened' to briefly every 3 seconds, to determine if there is any active radio communication.

→ **Note:** Watch modes are not available if ATIS mode is turned on.

Dual watch

Select this to watch the current channel and the priority channel (Channel 16).

TRI watch

Select this to watch the current channel, the user selected 'watch' channel, and the priority channel (Channel 16).

Set Watch Channel

Allows a watch channel to be selected from all available channels. Selected channel is used by TRI WATCH mode.

- **Note:** If the radio is configured for USA market, two priority channels are watched: Channel 9 and Channel 16.

Display

This menu allows the user to partially customize the screen information displayed, and adjust the screen for best visibility to suit the user and operating conditions.

Time display

Select to switch the display of Time to ON or OFF.

If turned ON, the display of COG/SOG is turned off, due to screen space constraints.

LOC (Local Time) is displayed below the time if a UTC (Coordinated Universal Time) offset has been entered; otherwise UTC is shown in its place if no offset has been applied.

POS display

Select to switch ON or OFF the display of position provided from connected GPS. If no GPS is connected and a manual entry has been made, the position will be displayed prefixed with an 'M'.

COG/SOG

Select to switch ON or OFF the display of COG/SOG provided from the selected GPS source.

If turned ON, Time display is turned OFF, due to screen space constraints.

Backlight

Backlight level

Select to make adjustment to the backlight level using the Channel knob. Range is OFF, then 1 to 10.

Press MENU SELECT button to activate night mode (inverts display).

Network group

Set this value to the same as other B&G devices on NMEA 2000 in order to control backlight levels simultaneously. To keep backlight control independent, set to a value not used elsewhere.

Contrast

Select to make adjustment of the screens contrast, using the Channel knob. Range is 00 to 10.

Radio setup

The Radio setup menu covers settings that are typically configured at installation, and seldom need changing.

Sensitivity

Use LOCAL/DISTANT to improve the sensitivity of the receiver either locally (LOCAL) or over distances (DISTANT).

LOCAL is not recommended for use in open sea conditions. It is designed for use in areas of high radio noise; for example, close to a busy port or city.

UIC

Select between USA, INT (International) or CAN (Canadian) channel banks. The selected channel bank is displayed on the LCD along with the last used channel. All the channel charts are shown in chapter 11.

→ **Note:** UIC is not available in EU country mode.

Power output

Select to toggle between HI (25 W) or LO (1 W) transmission power for the entire channel bank. The **HI** or **LO** is shown on the LCD, depending on your selection. Low power transmission draws significantly less current (about 1/4) from the battery, so is recommended for short range communication, and where battery capacity is limited.

→ **Note:** Some channels can't be switched to high power, and will show LO regardless of power output setting in menu.

CH name

CH NAME gives you the option to edit or delete the channel name descriptions displayed on the screen. Select to edit the existing

description of the channel currently in use. It can be a maximum of 12 characters long.

Key beep

Select to allow adjustment of key beep volume.

Volume can be set from 00 - 10 (where 00 is off, and 10 is loudest).

Units

Select SPEED to choose whether displayed in KNOTS, MPH, or KPH.

Select COURSE to toggle between displaying in MAGNETIC or TRUE. A true north heading is corrected for magnetic variation. A magnetic north heading source must also output magnetic variation data if the heading is to be displayed as a true north value.

Int speaker

Select to switch the radio's internal speaker ON or OFF.

Ext speaker

Select to switch the radio's external speaker ON or OFF.

GPS

Manual

Select MANUAL to enter a GPS position (and time) from another source when radio is not receiving position data from an internal or networked source.

The manually entered GPS position can be used in DSC calls.

If POS Display is turned ON, the latitude and longitude are shown on the screen with a prefix '**M**' indicating manual entry.

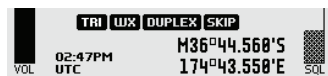

→ **Note:** The manual entry is automatically replaced when a real GPS position is received via the NMEA 0183, NMEA 2000 or Internal GPS, depending on the GPS SOURCE setting.

GPS source

- Choose NMEA 2000 for GPS via NMEA 2000 network. A list of available devices installed on your NMEA 2000 network will be displayed. Choose AUTO SELECT to pick the best GPS source visible

on NMEA 2000 or any other device listed.

- Choose NMEA 0183 to have the radio listen for GPS data on its serial NMEA 0183 port.
- Choose BUILT-IN to use the internal GPS system. You then have a choice of using the INTERNAL GPS antenna built into the radio, or an optional EXTERNAL GPS antenna connected to the radio external GPS antenna SMA port.

You can select an External (Networked) or Internal GPS source. A valid GPS source is required for DSC, AIS and Navigation functions:

Networked

If a networked source is selected, the  symbol will be displayed.

Once a valid fix is obtained,  will be displayed:

- Choose NMEA 2000 for GPS via NMEA 2000 network.

Internal

If an external GPS source is not available, select the internal GPS system, indicated by the  icon.

Once a valid fix is obtained, the icon will change to .

- Choose BUILT-IN to use the internal GPS system. You then have a choice of using the INTERNAL GPS antenna built into the radio, or an optional EXTERNAL GPS antenna connected to the radio via the GPS antenna SMA port.

GPS SIM

Select to toggle ON or OFF.

Whenever the GPS Simulator is turned ON, simulated Speed Over Ground (SOG), Course Over Ground (COG), and LL position appear on the screen. This is for the purpose of demonstration only. The SIM icon is displayed to warn the user it is in this mode.

→ Notes:

- It is not possible to send a DSC transmission when in Simulator mode.
- The GPS Simulator is set to OFF whenever the radio has the power cycled, or real GPS data is available.

COM port

The NMEA 0183 COM PORT is used by the radio to send and receive data. This is a global setting for the radios GPS, DSC and AIS functions.

Baud rate

Select 38400, or 4800 BAUD.

- **Note:** AIS generally requires 38400 Baud. The default setting is 38400, if 4800 is selected, a warning that 'data may be lost' is displayed.

Checksum

Select to toggle ON or OFF. When ON, NMEA 0183 data received is validated. If the checksum does not match, the data will be ignored. When OFF, there will be no tolerance to data corruption.

Time

Time offset

Select TIME OFFSET to enter the difference between UTC and local time. 15 minute increments can be used with a maximum offset of ± 13 hours.

- **Note:** Does not automatically adjust for Daylight Savings Time.

Time format

Select to toggle between 12 and 24 hour format.

Vessel call sign

Select to enter vessel call sign. Used by the MOB and AIS functions.

Auto power ON

Select AUTO for the radio to always turn ON when power is applied to the radio.

Menu timeout

An inactivity timeout can be set up to return the radio to normal operational mode when no activity is seen from the radio operator while radio is displaying a menu.

Select between NONE, 5 MINS, 10 MINS, and 15 MINS.
(default is 10 MINS).

- **Note:** A different timeout is used when the radio is left in a DSC call. See "DSC timeout" on page 31.

DSC setup

DSC function

It's recommended DSC functionality is always enabled, unless operating the vessel in an ATIS region. An MMSI number must be entered in radio before the DSC function can be enabled. When enabled, the **DSC** symbol is displayed.

User MMSI

Enter an MMSI number to access the radio's DSC functionality. This unique identifier must be supplied a local radio spectrum authority. **DO NOT** enter a random 'made up' number.

- **Note:** Contact a B&G dealer if you need to change your MMSI after initial input.

ATIS function (EU ATIS radios only)

ATIS must be enabled when navigating inland waterways in signatory countries of the RAINWAT agreement. It should NOT be used outside these regions. DSC functionality is not possible when ATIS is turned on. When enabled, the **ATIS** symbol is displayed.

Sea/Inland use (EU ATIS radios only)

Toggles between DSC (Sea) and ATIS (Inland) modes. Does not allow both to be selected at the same time.

ATIS ID (EU ATIS radios only)

Enter an ATIS number to access the radio's ATIS functionality. This unique identifier must be supplied a local radio spectrum authority. **DO NOT** enter a random 'made up' number.

- **Note:** Contact a B&G dealer if you need to change your ATIS ID after initial input.

Individual acknowledge

The radio can be configured to automatically acknowledge an incoming 'individual' call, or require manual intervention:

Auto

After a 15 second delay, radio will switch to requested channel, and send an automatic acknowledgement, ready for conversation. US country mode default.

Manual

Operator must manually choose to send acknowledgement, as well as change to requested channel. EU country mode default.

→ **Note:** This does not apply for calls types other than 'Individual'.

Position acknowledge (request)

The radio can be configured to automatically acknowledge an incoming position request, require manual intervention to acknowledge, or simply ignore them:

AUTO

Sends current position automatically to calling radio.

MANUAL

Operator must manually choose to send position information.

OFF

All incoming position requests are ignored.

Auto switch (channel)

This setting only relates to All Ships and Group DSC calls.

When a DSC call is received, it may include a request to change to a specific channel for subsequent communications.

With AUTO SWITCH set to ON, the radio will switch channels after a 10 second delay. The radio will also display options to switch immediately, or reject the request and stay on the current channel.

With AUTO SWITCH set to OFF:

- Any channel change request will require manual confirmation.
- The following symbol will be displayed: 

Test acknowledge

The radio can be configured to automatically acknowledge an incoming test call, or require manual intervention:

Manual

Operator must manually choose to send acknowledgement, or cancel.

Auto

The DSC test call is automatically acknowledged after a 10 second delay.

Receive distress while off

Enabling this feature will allow the radio to raise an alert for DSC distress calls, even when the DSC feature is turned off. This will work regardless of whether or not an MMSI number has been entered.

DSC timeout

An inactivity timeout can be set up to return the radio to normal operational mode when no activity is seen from the radio operator while radio is engaged in a DSC call.

Distress calls have a discrete timer from that used for all other DSC calls:

Distress

Select between NONE, 5 MINS, 10 MINS and 15 MINS. (default is NO TIMEOUT).

Non Distress

Select between NONE, 5 MINS, 10 MINS and 15 MINS. (default is 15 MINS).

AIS setup

This radio is equipped with an AIS receiver which can receive information from other vessels transmitting AIS information.

AIS function

Select the checkbox to enable the AIS receiver functionality. When enabled, the **AIS** symbol is displayed.

AIS display

When viewing the AIS plotter screen, AIS targets can be displayed with the vessels NAME or the vessels MMSI.

CPA

Set the Closest Point of Approach (CPA) distance. CPA is the minimum distance between you and a target vessel based on the current speed and course. You can set the minimum distance in 0.1 NM increments between 1 NM to 25 NM.

You must have CPA ALARM set to ON in the ALARMS menu. If set to OFF, there will be no CPA alarms regardless of the above settings.

TCPA

Set the Time to Closest Point of Approach (TCPA) interval. TCPA is the minimum time to reach the CPA distance before the CPA alarm is activated. You can set the minimum time in 30 seconds increments between 1 MIN to 30 MIN.

Alarms

GPS alert

The GPS alert is a warning to the user that the selected GPS source is not outputting valid position data. It comprises of an audible alarm and visual alarm (screen flash and warning text).

GPS alert function

Turns ON or OFF all alerts for missing GPS data, including audible alarm, screen flash, and warning text.

Alert volume

Select between HIGH, LOW, and OFF.

Screen flash

Select between ON and OFF.

WX alert (US/CAN only)

The WX alert is a warning to the user that a special weather station alert has been received. It comprises of an audible alarm and visual alarm.

WX alert function

Turns ON or OFF the radios response to weather alerts. This includes; automatic switching to the last used weather channel, audible alarm, screen message, and flashing backlight.

Alert volume

Select between HIGH, LOW, and OFF.

Screen flash

Select between ON and OFF.

DSC Alarm

The alert volume and screen flash for some incoming call types can be altered.

SAFETY, ROUTINE and URGENCY calls can individually be set to have:

Alert volume

HIGH, LOW or OFF.

Screen flash

ON or OFF.

→ **Note:** It is not possible to alter distress call alert settings.

CPA Alarm

The CPA alarm informs the user of potentially dangerous situations where another vessel may come within a certain distance of your vessel. This value is set in the AIS Setup menu, page 31.

Enables the CPA alarm. If set to OFF, there will be no T/CPA alarms regardless of the settings. It comprises of an audible alarm and visual alarm (screen flash and warning text).

Alert volume

HIGH, LOW or OFF.

Screen flash

ON or OFF.

Wireless handset

A maximum of two optional H60 wireless handsets can be paired with this radio. A wireless handset provides you with the freedom to operate your VHF Radio as if you were controlling the radio directly.

Before a wireless handset can be used with the radio, it must be paired with the radio through the pairing process.

Pair a handset

Before a wireless handset can be used with the radio, it must be paired with the radio. The pairing process only needs to be performed once per handset (maximum of 2 handsets can be paired to the radio):

1. Ensure the handset, that you want to pair to the radio, is charged and turned OFF.

- **Note:** If you have another handset that is already paired to the radio, ensure it remains off during this procedure.
- 2. On the base station radio's MAIN menu, select WIRELESS HANDSET.
- 3. Select PAIR A HANDSET. Select YES.
- 4. Turn ON the handset that you want to pair to the radio. The handset display will show SEARCHING...
- 5. Press and hold SCAN button on the handset until HANDSET IS PAIRING appears.
- 6. Each paired handset will be identified by either HS1 or HS2 text above the channel number.
- **Note:** This pairing process may take up to 1 minute to complete."

Remove a handset

To delete an already paired handset:

1. Select REMOVE A HANDSET.
2. Select the handset you wish to remove, press ENT and then YES.

Reset

Use this setting to return every setting to the factory defaults except all MMSI settings, entries in your buddy list and any customized channel names.

3

DSC call menu

DSC (Digital Selective Calling) is a semi-automated method of establishing VHF, MF, and HF radio calls. One big advantage that DSC enabled radios offer is that they can receive calls from another DSC radio without being on the same channel as the calling radio. The calling radio will provide details on what channel to switch to so that voice communication can be established. There are various types of DSC calls - the type of call made determines information sent with the call, and how other radios respond to the incoming call.

Short press the DSC button for the following options:

- DSC Calls
- Track Buddy
- Contacts list

DSC calls

There are four call types, as well as related options, that can be accessed from this menu.

Individual

Used to place a call to a single other vessel.

The call can be initiated by selected an existing vessel in the CONTACTS; by entering in a new vessel's MMSI (MANUAL); or by selecting a vessel in the RECENT list.

When the SEND TO page is displayed, turn the channel knob to select the channel to use for voice communication.

Distress

The distress menu can be accessed via the DSC Calls menu, or directly by a short press of the Distress key on the front of the radio.

The nature of the distress call must be selected from the list of options - this will be displayed on other radios receiving the call.

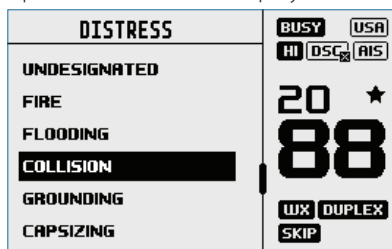

After the Distress Call is sent, the radio waits for an acknowledgment.

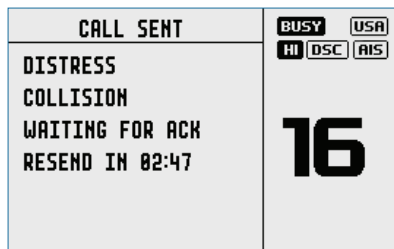

The Distress Call is automatically re-sent every 3.5 to 4.5 minutes until a distress acknowledgement is received.

Alternatively the operator can select:

RESEND (under OPTION - access by pressing the Menu/DSC button) used to immediately resend the Distress Call.

PAUSE (under OPTION - access by pressing the Menu/DSC button) used to pause the automatic Distress Call resend timer.

CANCEL (press X button) to cancel the Distress Call.

If a distress cancel is sent, the display shows PTT --> REASON, prompting the operator to state the reason for the cancellation.

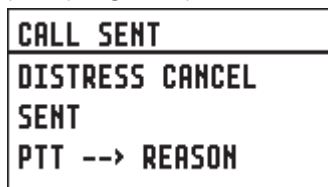

After a DISTRESS ACK is received, the alert should be silenced, and the reason for distress should be clearly stated, pressing the 'PTT' on the MIC and talking.

The following information (if available) is contained in the Distress Call:

- Nature Of Distress (if selected).
- Position information (the latest GPS or manual input position is held for 23.5 hours, or until the power is turned OFF).

Group

Used to place a call to a known group of vessels, all using the same 'Group Call ID' (GCID) number.

The call can be initiated by selecting an existing group from the group list, by entering a new GCID, or by selecting a group from the RECENT list.

When the SEND TO page is displayed, turn the channel knob to select the channel to use for voice communication.

All ships

Used to place a call to ALL DSC equipped vessels in range, much like a distress call. The nature of the call must be selected, and can be either SAFETY or URGENCY.

When the SEND TO page is displayed, turn the channel knob to select the channel to use for voice communication.

Call logs

Shows a record of SENT, RECEIVED, and DISTRESS calls.

POS request

Used to send a position request to another vessel. The call can be initiated by selecting an existing vessel in the CONTACTS, by entering in a new vessel's MMSI (MANUAL), or by selecting a vessel in the RECENT list.

As no voice communication is required, no option is given to select a ship-ship channel.

POS report

Used to send a position report to the vessel being called.

DSC test

Used to place a TEST call to a single other vessel. The call can be initiated by selecting an existing vessel in the CONTACTS, by entering in a new vessel's MMSI (MANUAL), or by selecting a vessel in the RECENT list.

Communication channel selection is not possible.

MMSI/GPS

Shows entered MMSI number and GPS fix information.

Track buddy

Short press the DSC button to access the Track Buddy function.

Up to 5 vessels from the Contacts list can be sent recurring position requests, at an adjustable time interval. The buddy list is saved in the memory, and tracking can be turned on and off as required.

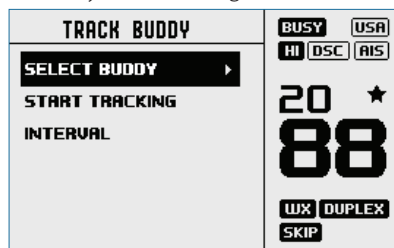

Select buddy

Shows any existing 'buddies' already selected, and the option to add more. Selecting a 'buddy' already in the buddy list will remove them.

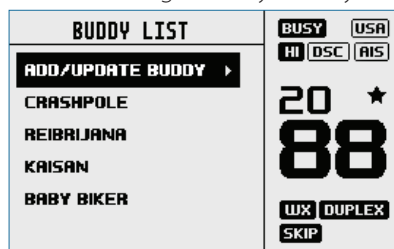

Choose ADD/UPDATE BUDDY to view the full contacts list, and choose who to add for tracking.

Start tracking / Stop tracking

Selecting START TRACKING option initiates tracking of buddies in the Track buddy list that have been set to tracking ON. The radio will show a screen indicating which buddy is being called. If there is no acknowledgement, the radio will retry the call after a few seconds. Only one retry is made per tracking interval.

If tracking is already taking place, the START TRACKING text is replaced with STOP TRACKING.

Interval

The frequency that 'buddies' are polled with position requests can be selected between: 5, 15, 30 and 60 minutes.

Contacts

Used for the administration and calling of all individual Contacts as well as Groups.

View/Add Contact

Use this to store the names and associated MMSI's of up to 50 vessels to be called regularly using DSC. Contacts are stored by name, in alphabetical order.

Select ADD NEW to create a new contact.

Selecting an existing name in the Contacts list gives the options to place a DSC call, make a position request, edit the contact, or delete the contact.

View/Add Group

Use this to create, edit, or delete up to 20 vessel groups, which are stored in alphanumeric order. Only a name and a Group Call ID (GCID) are required to set up a group. A GCID always starts with 0; the remaining digits can be set to whatever the user desires. All vessels intended to be in the same group must have a suitable DSC radio, and have the identical GCID number entered.

Selecting an existing name in the group list gives the option to edit, delete, or call the group.

- **Note:** Adding a group to this list will in turn make the radio respond to a group call made from any other radio with the same group number in it's memory.

4

AIS menu

 **Warning: Valid GPS data must be entered into this radio before the AIS functions can be used. The plotter PPI function will not display targets accurately with incorrect GPS data.**

About AIS

The marine Automatic Identification System (AIS) is a location and vessel information reporting system. It allows vessels equipped with AIS to automatically and dynamically share and regularly update their position, speed, course and other information such as vessel identity with similarly equipped vessels. Position is derived from the Global Positioning System (GPS) and communication between vessels is by Very High Frequency (VHF) digital transmissions.

There are a number of types of AIS device as follows:

- Class A
Vessel-mounted AIS transceiver (transmit and receive) which operates using SOTDMA. Targeted at large commercial vessels, SOTDMA requires a transceiver to maintain a constantly updated slot map in its memory such that it has prior knowledge of slots which are available for it to transmit. SOTDMA transceivers will then pre-announce their transmission, effectively reserving their transmit slot. SOTDMA transmissions are therefore prioritised within the AIS system. This is achieved through 2 receivers in continuous operation. Class A's must have an integrated display, transmit at 12.5 W, interface capability with multiple ship systems, and offer a sophisticated selection of features and functions. Default transmit rate is every few seconds. AIS Class A type compliant devices receive all types of AIS
- Class B
Vessel-mounted AIS transceiver (transmit and receive) which operates using either carrier-sense time-division multiple-access (CSTDMA) or SOTDMA; there are now 2 separate IMO specifications for Class B. Aimed at lighter commercial and leisure markets. CSTDMA transceivers listen to the slot map immediately prior to transmitting and seek a slot where the 'noise' in the slot is the same or similar to background noise, thereby indicating that the slot is not being used by another AIS device. Class Bs transmit at 2 W and are not required to have an integrated display; Class Bs can be connected to most display systems where the received messages will be displayed in lists or overlaid on charts. Default transmit rate is normally every 30 seconds, but this can be varied according to

vessel speed or instructions from base stations. The Class B type standard requires integrated GPS and certain LED indicators. Class B equipment receives all types of AIS messages.

- AIS base stations. AIS base stations are used by Vessel Traffic Systems to monitor and control the transmissions of AIS transceivers.
- Aids to Navigation (AtoN) transceivers. AtoNs are transceivers mounted on buoys or other hazards to shipping which transmit details of their location to the surrounding vessels.
- AIS receivers. AIS receivers will generally receive transmissions from class A transceivers, class B transceivers, AtoNs and AIS base stations but do not transmit any information about the vessel on which they are installed.

This radio contains an AIS receiver only function.

Using the AIS receiver

Providing that other vessels with AIS transceivers installed are within radio range of your vessel, you should see their details appear on the AIS plotter screen. These details are also repeated on the NMEA ports for display on a compatible chartplotter / MFD.

Specific details of how to configure your chartplotter to make use of the AIS receiver features will be given in your chartplotter manual.

If you are using charting software running on a PC, please refer to the instructions provided with your chartplotting software for details of how to configure it to display AIS information.

AIS information and display

 **Warning: Not all vessels transmit AIS information and therefore not all vessels will be displayed or listed in the following AIS screens.**

AIS vessel information can be displayed on the radios LCD screen:

1. **Short press** the AIS/IC button to display the AIS plotter screen.
- **Note:** You must have LAT/LON position information for targets to be displayed on the plotter PPI.

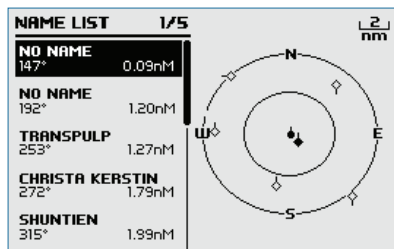

2. AIS target details will be displayed on the left of the screen. Either the vessels name or MMSI will be displayed (if the information is available) depending on the setting you selected in Section “6-2 AIS data display format (AIS DISPLAY)”. Also the target’s bearing and distance to you are displayed.
- **Note:** It could take some time before AIS targets are displayed.
3. A simple plotter PPI on the right hand side of the LCD shows the geographical location of the AIS targets with respect to your position which is in the center of the plotter PPI.
 4. Press the Zoom In (TRI) or Zoom Out (Scan) keys to change the scale of the plotter. The scales available are 1, 2, 4, 8, 16, 32 nm.
 5. Press the AIS/IC key again to change the display to T/CPA Approach screen.
 6. Rotate the knob to highlight any AIS target shown on the plotter screen. The selected target will have the target symbol filled in.

OCEANIC.DISCOVERER			
STATUS: UNDERWAY USING ENGINE			
DISTANCE:	1.62nm	SOG:	9.9KTS
BEARING:	285°	COG:	219.0°T
CPA:	1.62nm	ROT:	0.0/5
TCPA:	1h 37m	HEADING:	195.0°T
WIDTH:	0.0m	MMSI:	503492000
LENGTH:	60.0m	IMO:	9292747

7. Press ENT to view full details of the highlighted target such as MMSI, Vessel name, distance, bearing, heading, ROT, COG, SOG, status and other vessel information.



T/CPA approach screen

1. When in AIS mode, press the AIS/IC key again to toggle between the standard AIS screen and the T/CPA Approach screen.
2. In TCPA Approach mode, the approaching AIS target’s details are listed on the left side along with it’s geographical position on the plotter PPI.

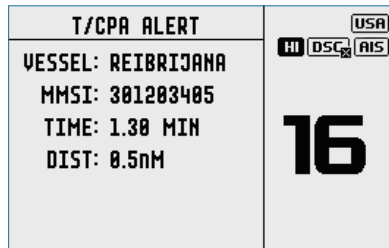

3. The zoom range is automatically selected to the best range according to the selected target on the left.
 4. Press +/- button or rotate the CH knob to select the target, press ENT key to display target information, or press X key to return to the previous display.
- **Note:** If the radio detects a TCPA or CPA breach, the T/CPA Approach Alert screen will automatically pop up with an alert tone. Press X to stop the alert. The alert will sound again after 1 minute if the AIS alarm has not been resolved.



Plotter symbols and meanings

-  Your vessel is always in the center of the plotter screen. You are represented by a solid circle, along with a small line that indicates your bearing with respect to North.
-  All other vessels or targets displayed on the plotter screen are represented by a diamond shape. These are targets around your vessel that are within the current zoom distance setting. The small line indicates the targets bearing.
-  When a target is selected, it is represented by a solid diamond.

Examples:

-  You and the target vessel are heading **away** from each other.
-  You and the target vessel are heading **towards** each other.

- **Note:** Nautical Miles is the only unit used in AIS mode.

5

Hailer / Fog Horn / Intercom

An appropriate Hailer speaker must be connected to the Hailer wiring before the HAILER or FOG HORN functions can be used.

Using the Hailer (PA) function

The Hailer function allows you to make an announcement at high volume through the Hailer speaker to people or vessels using the hand mic.

The Hailer function also features a LISTEN mode - this mode uses the Hailer speaker as a microphone to listen for a response on the main radio. LISTEN mode is not available on the optional wireless handset.

1. **Long press** the AIS/IC button to enter IC mode.

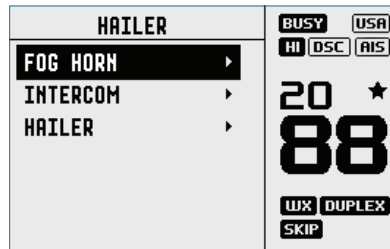

2. Select HAILER and press ENT.
 - Press PTT to talk through the hailer. Rotate the volume knob to change the volume. Volume can only be changed while the PTT is pressed.
 - Release PTT to LISTEN for a response.
 - Press X to return to normal radio operation mode.
- **Note:** It is not possible to enter HAILER mode from the optional wireless handset.

Using the Fog Horn

The FOG horn will sound certain international standard fog horn tones through the Hailer speaker depending on the mode selected.

1. **Long press** the AIS/IC button to enter Hailer mode.
2. Select FOG HORN and press ENT.

There are 8 choices of internationally recognized fog horn sounds and timing:

HORN	Horn tone	Manual operation
UNDERWAY	1 long tone	Automatically every 2 minutes
STOP	2 long tone	Automatically every 2 minutes
SAIL	1 long, 2 short	Automatically every 2 minutes
ANCHOR	1 long warble	Automatically every 2 minutes
TOW	1 long, 3 short	Automatically every 2 minutes
AGROUND	Warble sequence	Automatically every 2 minutes
SIREN	Siren tone	Manual operation

- Scroll through the menu to select a fog horn type, then press ENT to start the selected fog horn sounding. All except HORN and SIREN will sound automatically.
- The fog horn will sound automatically approximately every two minutes until you press X to cancel it. When the fog horn is not sounding, it is in LISTEN mode.
- To operate HORN or SIREN, once selected, press and hold the ENT button. This will sound as long as the ENT button is pressed. You can then also operate PTT to talk through the Hailer.
- To change the volume, rotate the volume knob to change the volume when the fog horn is sounding.
- Press X to return to normal radio operation mode.

Using the Intercom facility

The Intercom mode works **only** when one or two optional H60 wireless handset(s) are installed.

1. **Long press** the AIS/IC key and select INTERCOM.
2. Press PTT to talk to the handsets. Release PTT to hear a reply.
3. Press X to quit the INTERCOM mode.

6

Wireless handset

This radio can operate with up to two optional H60 wireless handsets. When a wireless handset is successfully 'paired' to the radio, the buttons and screens on each device will be mirrored.

→ **Notes:**

- The H60 must be paired to the V60 base station radio before it can be used. See "Pair a handset" on page 33 on how to pair the wireless handset to the V60.
- Maximum of two handsets can be paired with the V60.

Using the wireless handset

Once the H60 handset has been paired to the V60, the screen and button functionality are mimicked on each device.

Most functions that are provided on the V60 can be accessed by the H60 with the following exceptions:

- SETUP: Some setup functions are not available on the H60.
- HAILER: It is not possible to enter HAILER mode from the H60.

When the H60 is not in use, it should be placed back into the charger cradle. The H60 is charged when placed in the cradle via the built-in contactless inductive charging system.

Long press the X button to turn the wireless handset on. The handset will display the software version and then attempt to re-connect with the base station radio. Once connected use the wireless handset in the same way as you would be using the base station radio.

Long press the X button to turn the wireless handset Off. The handset will automatically turn off after 90 seconds of no communication with the base radio.

Using the Intercom facility

The Intercom mode works **only** when one or two optional H60 handset(s) are installed.

1. **Long press** the AIS/IC key and select INTERCOM.
2. Press PTT to talk to the base station (and other handset if installed). Release PTT to hear a reply.
3. Press X to quit the INTERCOM mode.

7

My channels

The MY CHANNELS page is accessed by a long press of the channel knob.

This page provides a shortcut to frequently accessed channels.

The first time this page is opened, the entire channel list is shown so that the desired shortcut channels can be selected.

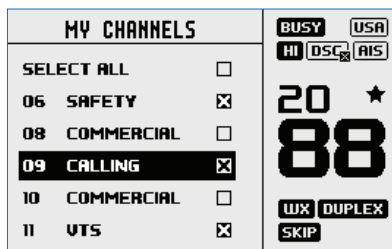

Subsequent opening of this page will show a list of only the selected channels. Choosing one of the channel options immediately exits the page and sets the radio to that channel.



The available shortcut channels can be changed at any time using EDIT MY CHANNELS.

- **Note:** Channels on this list are also used in some SCAN options. Access to edit the MY CHANNELS list is also available from the SCAN menu.

8

Shortcuts

The Shortcuts page is accessed by a long press of the VOL/SQL knob.

This page is provided as a shortcut to frequently accessed settings. The shortcut options available on this page are subject to selections made in ADD/EDIT SHORTCUTS.

Add/Edit shortcuts

Choose from the list of options which menu options should be added as shortcuts:

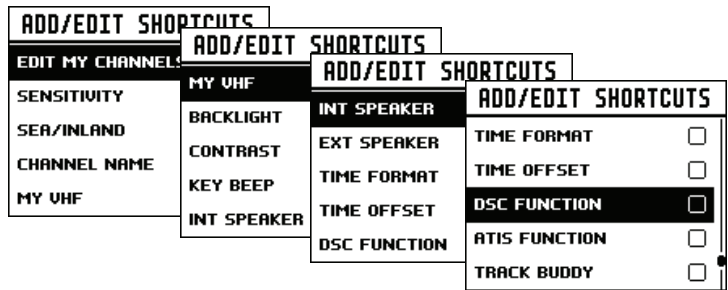

- **Note:** The MY VHF page is only available to the operator when enabled as a shortcut - it can't be accessed via another menu. It's purpose is solely for displaying radio information in one easy to access location. It provides detail on the MMSI number, GPS data status, and Vessel Callsign (if entered).

Once the desired shortcuts have been selected, they are accessible directly from the Shortcuts page:

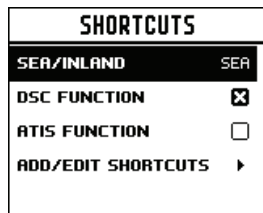

9

Installation

What's in the box

The following items should be supplied in the box. Check before starting the installation and contact your dealer if an item is missing.

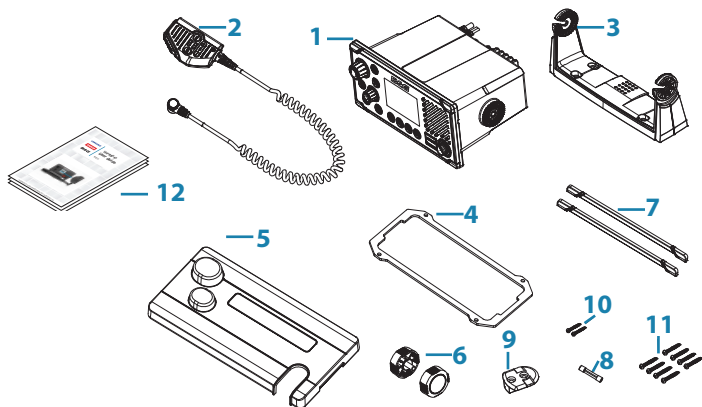

1. VHF radio
2. Removable hand mic
3. Bracket for gimbal mounting
4. Gasket for recessed mounting
5. Sun cover
6. Knobs for bracket
7. Bezel trim
8. 8 A (3 AG) spare fuse
9. Bulkhead mount for hand mic
10. 2 pcs 3.5 x 20 mm, stainless steel, panhead Phillips
11. 8 pcs 4 x 25 mm, stainless steel, panhead Phillips.
12. Documents: user's manual, warranty card, mounting template.

Before you start:

- A VHF antenna is not provided. Consult your B&G dealer for advice on selecting the correct antenna for your installation.
- This radio must only be connected to a 12V DC, Negative ground power source.
- Do not install in a Hazardous / Flammable environment.

Installation options

There are two mounting options for the radio.

- Bracket mount:
Using the supplied gimbaling bracket the radio can be mounted to either sit on top of, or hang underneath any flat horizontal surface. The radio can be removed for storage and the viewing angle can be adjusted.
- Flush mount:
The radio is recessed into a cavity, showing only the face of the radio. The radio fixture is permanent and the viewing angle cannot be adjusted.

Selecting a suitable mounting location

Whichever installation method you choose, please check the following before doing any cutting or drilling. The chosen location must:

- Be at least 1 m (3') from the VHF antenna.
- Allow easy access to the rear of the radio for connection to the 12 V DC electrical source, the antenna and any network wiring.
- Be at least 45 cms (1.5') from a compass to avoid creating magnetic deviation of the compass.
- Have a suitable space close by for installing the microphone bulkhead mount.
- Provide easy access to the controls on the front panel.
- If intending to use the built-in GPS antenna, it must be in a location that provides optimal GPS performance, see "Built-in GPS considerations" on page 51.

Viewing angle

The VHF radio has a large LCD screen with the optimum horizontal and vertical viewing angles within approx. +/-20 deg. Ensure the chosen location provides a suitable view of the display. Ideally, the user should be directly in front of the display or no more than +/-20 deg from the front of the display.

- ➔ **Note:** If unsure, temporarily power up the radio and ensure the location is suitable.

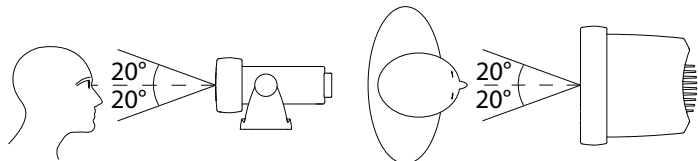

Built-in GPS considerations

1. The built-in GPS antenna is mounted in the front face of this radio above the speaker grill.
2. If you intend to use the built-in GPS Antenna in this radio, you must ensure a suitable mounting location that allows optimal GPS performance.
3. There must not be any metallic or large obstacles in the path between the radio and the sky. The more obstacles in the way, the weaker the GPS signal getting to the antenna.
4. If the radio is mounted in an alloy or ferrous boat, or below decks, then an external GPS antenna is recommended. Seek professional guidance if unsure.

Bracket installation

The gimbal bracket provides an adjustable viewing angle with a 20° tilt range, so ensure the selected mounting location will provide the desired viewing and operating conditions:

1. Hold the bracket at the chosen location and use a soft pencil to mark the screw hole positions onto the mounting surface.
2. Use a 3 mm (1/8") drill bit to drill the 4 pilot holes.
3. Using a Phillips screwdriver, secure the bracket using the supplied 4x25 mm selftapping screws to the mounting location.
4. Fit the radio into the bracket.
5. Insert the two mounting knobs through the holes and tighten them sufficiently to hold the radio at the desired viewing angle.
6. Fit the bezel trim to the front of the radio to cover dash mount screw holes.

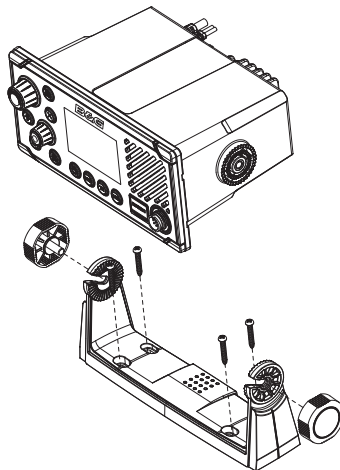

Flush installation

1. Tape the installation template onto the chosen mounting location.
2. Cut out the area marked by the solid dark line (the dashed line indicates the total area that will be covered by the radio fascia after installation).
3. Use a 2.5 mm (3/32") drill bit to drill the 4 pilot holes.
4. Remove the installation template.
5. Fit the gasket to the radio.
6. Slide the radio into the cavity.
7. Using a Phillips screwdriver, secure the radio using the supplied 3.5x20 mm selftapping screws to the mounting location.
8. Fit the bezel trim to cover the 4 mounting screws.

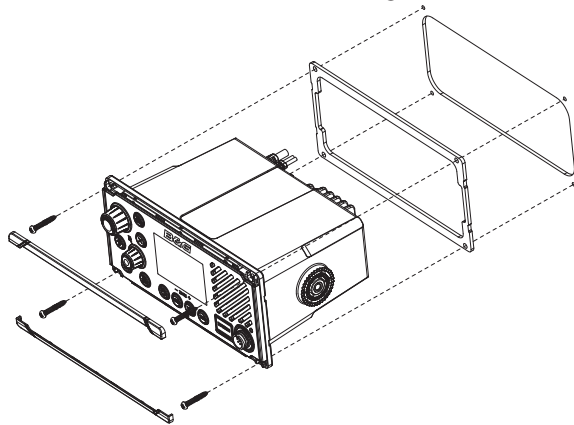

Install the hand mic bulkhead bracket

1. Hold the hand mic bulkhead bracket at the chosen location and mark the screw hole positions on the mounting surface.
- **Note:** Ensure that the microphone curly cable will comfortably reach this location BEFORE you drill.
2. Use a 2.5 mm (3/32") drill bit to drill the 2 pilot holes.
 3. Using a Phillips screwdriver, secure the Mic mount using the supplied 3.5x20 mm selftapping screws to the mounting location.

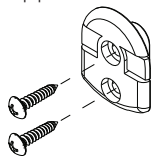

4. Hang the fist mic on the mount.

Install the external GPS-500 Antenna (optional)

It is **not** recommended that the GPS antenna is mounted up a mast where the motion of the vessel will cause the antenna to swing and potentially reduce the accuracy of the GPS position.

Do not mount the GPS antenna within 1 m of a transmitting device.

Mount the GPS-500 to either a pole or hard surface then run the cable to the transceiver. In all cases, ensure the selected location enables the antenna to have a clear, unobstructed view of the sky.

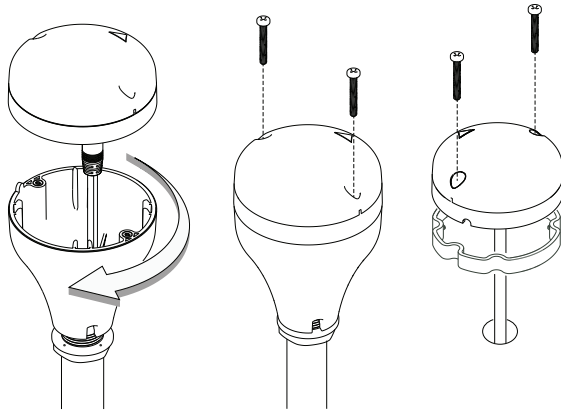

To **pole mount** the external GPS-500 antenna, you will require a 1-inch 14 TPI thread pole:

- Screw the pole adapter onto the threaded portion of the pole.
- Feed the cable attached to the GPS antenna through the adapter and pole.
- Mount the pole into position.
- Fit the GPS antenna to the pole adapter using the 2 small screws.

To **surface mount** the external GPS-500 antenna, select a flat clean surface area that has a clear view of the sky. Mount the antenna using the supplied gasket and the 2 small screws:

- Mark and drill the 2 mounting holes and a further hole if necessary for the GPS cable.
- Install the gasket by firstly threading the attached cable through the centre of the gasket.
- Screw the GPS antenna to the mounting surface.

→ **Note:** Ensure the surface mounting area is clean with no dirt, old paint or debris.

- Run the GPS cable to the transceiver:

- Route the cable to your VHF transceiver unit, adding any necessary extension cables.
- Connect the cable from the GPS antenna to the GPS connector (SMA) on the VHF transceiver as shown below.

Connect the radio wiring

All wiring on the radio should be done with the vessel power supply turned off. While radio power is polarity protected, the fuse will blow if the connection is made the wrong way round. Ensure any unused bare wires are isolated from each other, to prevent the potential of a short circuit. If using the NMEA 2000 connection, ensure network topology rules are followed closely.

⚠ Warning: never operate the radio without the antenna connected. This may damage the transmitter.

The connectors are on the rear of the base unit, as follows:

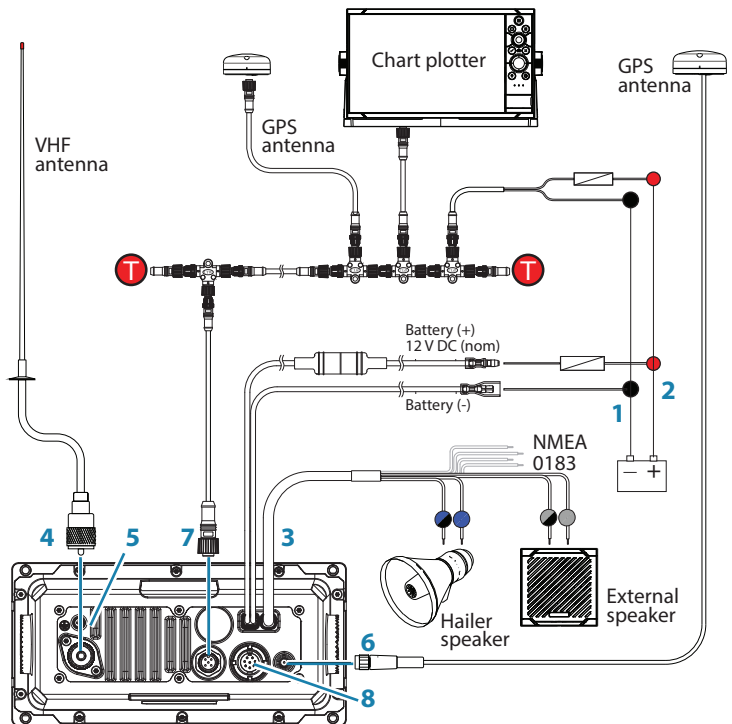

1. Battery - (BLACK): connect to vessel's negative busbar.
2. Battery + (RED): connect to vessel's 12 V DC, via a switch panel or breaker (comes with inline 8 amp fuse ready fitted).

3. Auxiliary port connections as follows:

Wire color	Item	Connect to
GRAY	External speaker +	Positive terminal of the optional external speaker.
GRAY/BLACK	External speaker -	Negative terminal of the optional external speaker.
YELLOW	NMEA 0183 RX_A	TX_A of chart plotter, or active GPS antenna.
GREEN	NMEA 0183 RX_B	TX_B of chart plotter, or active GPS antenna.
WHITE	NMEA 0183 TX_A	RX_A of chart plotter.
BROWN	NMEA 0183 TX_B	RX_B of chart plotter.
BLUE	Hailer speaker +	Positive terminal of the optional Hailer speaker.
BLUE/BLACK	Hailer speaker -	Negative terminal of the optional Hailer speaker.

4. Antenna: connect to a marine VHF antenna using 50 ohm cable fitted with a PL-259 connector.
 5. GND: optional ground connection. May help with induced noise issues.
 6. GPS antenna (SMA): connect to external passive GPS antenna.
 7. NMEA 2000 network connection. Can be connected to a NMEA 2000 compatible MFD with built-in GPS or external GPS antenna.
 8. Handset microphone (rear) connection: Alternative connection for the removable handset microphone. Optional 1 m and 5 m extension cable available.
- **Note:** External speaker, Hailer, passive GPS antenna and plotter connections are optional.

Cradle charger (BC-12)

What's in the box

1. Cradle charger
2. 2 pcs 4 x 25 mm, stainless steel, panhead Phillips
3. Documents: warranty card, mounting template

Wiring instructions

1. Connect the red wire to battery (+) via 2A fuse (not provided)
2. Install an optional power switch
3. Connect the black wire to battery (-)

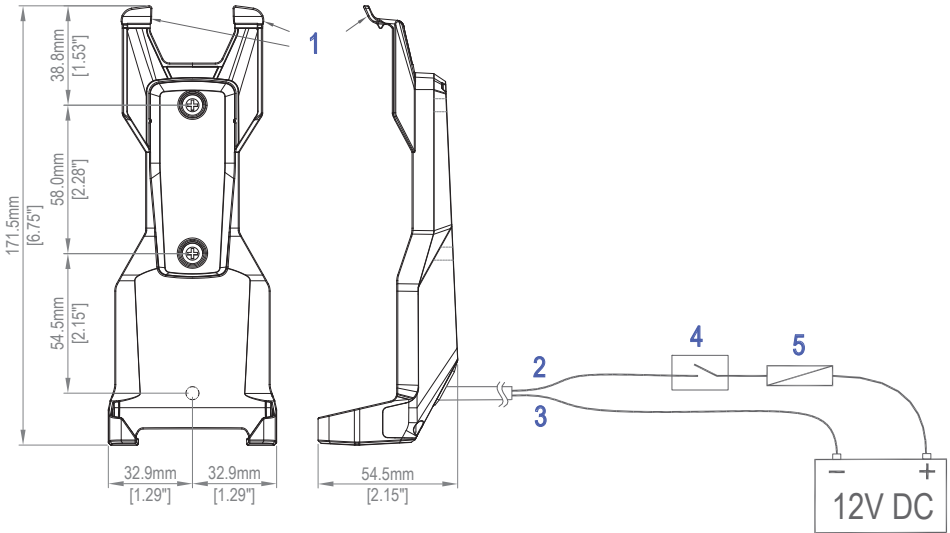

1. Handset release tabs
2. Red wire
3. Black wire
4. Switch
5. Fuse 2A

First startup configuration

The first time the radio is powered up, the user is prompted to make a series of setting selections in order to allow the radio to perform to its full potential. Some steps must be completed; some are optional and can be completed later. The steps are outlined below for reference:

1. Select the country and region the radio will be operated in:

COUNTRY MODE	
USA/CAN	▶
EU	▶
INT	▶
<small>DSC MENU</small> ◀	✕ BACK

2. Enter MMSI number if known, or skip to next step. Re-enter number to confirm correct entry:

USER MMSI	
ENTER MMSI:	
_ _ _ _ _	
PRESS TRI TO SKIP	
<small>DSC MENU</small> ◀	✕ BACK

→ **Note:** MMSI entry can only be done once. Changing the MMSI requires radio be returned to a B&G dealer.

3. If you have selected the Country mode to be EU, some EU regions require you to setup ATIS. Enter the ATIS ID number. Re-enter number to confirm correct entry:

USER ATIS	
ENTER ATIS:	
9_ _ _ _ _	
PRESS TRI TO SKIP	
<small>DSC MENU</small> ◀	✕ BACK

4. Enter vessel call sign if known, or skip to next step (maximum 7 digits):

VESSEL CALL SIGN	
ENTER:	
_ _ _ _ _	
PRESS TRI TO SKIP	
<small>DSC MENU</small> ◀	✕ BACK

5. Select a GPS source:

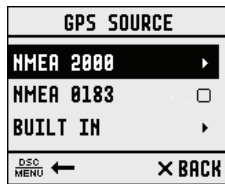

6. Set the time offset for your region. Choose whether to display time in 12 or 24 hour:



10

Specifications

GENERAL

Power supply:	12 V DC battery system
Nominal operating voltage:	+ 13.6 V DC
Low battery alert:	10.5 V DC +/- 0.5 V
Over voltage protection:	> 15.8 V +/- 0.5 V
Current drain (Transmit):	≤ 6 A @ 25 W / 1.5 A @ 1W (12 V DC)
Current drain (Receive):	Less than 450 mA in standby
Replacement Fuse:	8 A, Glass type 3 AG; 32 mm (1.25")
Temperature range:	-20 °C to +55 °C (-4 °F to 131 °F)
Usable channels:	International, USA, Canada, Weather (country specific)
Mode:	16K0G3E (FM) / 16K0G2B (DSC)
DSC mode:	Class D (Global) with dual receiver (individual CH70)
Standards - EU:	EN 60945:2002, EN 60950-1:2006 +A11:2009+, A1:2010+A12:2011 +A2:2013, EN 62311:2008, EN 301 843-1 V2.2.1, EN 301 843-2 V2.2.1, EN 301 489-1 V2.1.1, EN 301 489-5 V2.2.0, EN 301 489-17 V3.1.1, EN 301 489-19 V2.1.0, EN 301 025 V2.2.1, EN 300 698 V2.2.1, EN 303 413 V1.1.1, EN 300 328 V2.1.1
Standards - US/CAN:	US/CAN: FCC Part 80, RSS-Gen Issue 5, RSS-182 Issue 5, FCC Part 18
Standards - INT:	AS/NZS ETSI EN 301 025
Standards - AIS:	ITU-R M.1371-5
Frequency range, - Transmitter:	156.025 - 157.425 MHz
- Receiver:	156.050 - 163.275 MHz
Channel spacing:	25 KHz
Frequency stability:	± 5 ppm
Frequency control:	PLL
Software version (at time of release)::	v3.21

Equipment category - V60: B (Protected)

Equipment category - H60: A (Portable)

PHYSICAL

LCD display: FSTN 256x160 pixels, monochrome

Contrast control: Yes

Backlight synching: Yes, via NMEA 2000 network

Backlight: White LED; adjustable in 10 levels;
Day and Night mode

VHF antenna connector: SO-239 (50 ohm)

GPS antenna connector: SMA (female)

Waterproof: IPx7

Dimensions: W=201.2 mm (7.92") x H=97.8 mm
(3.85") x D=163.3 mm (6.43") -
without bracket

Weight: 1.46 kg (3.2 lbs)

Compass safe distance: 0.5 m (1.5')

NMEA 0183 port: Yes

NMEA 0183 input: RMC, GGA, GLL, GNS

NMEA 0183 output: Yes, DSC (for DSC call), DSE (for
enhanced position), MOB

NMEA 2000 port: Yes

External speaker: Yes - 4 ohms, minimum 4 W

Hailer speaker: Yes - 4 ohms, minimum 30 W

Handset mic: Removable.

Front or rear mount connector

FEATURES

Flush mount kit: Yes

Local/Distant control: Yes

Position polling: Yes

Group call: Yes

Call logs: Yes - 20 individual and 10 distress

Channel naming: Yes

Tri watch: Yes

Favourite channel scan:	Yes
All scan:	Yes
User programmable MMSI:	Yes
MMSI and NAME directory:	Yes - 20 numbers & group
Software updates:	Yes, via NMEA 2000

TRANSMITTER

Frequency error:	$\leq \pm 1.5$ KHz
Output power:	25 W (23 ± 2) / 1 W (0.8 ± 0.2)
Transmitter protection:	Open / short circuit of antenna
Max Frequency deviation:	$\leq \pm 5$
Spurious & harmonics Hi/Lo:	$\leq 0.25 \mu$ W
Modulation Distortion ± 3 KHz:	≤ 10 %
S/N at 3KHz Deviation:	≥ 40 dB
Audio Response at 1KHz:	+1 to -3dB of 6 dB/octave from 300 hz to 3 KHz
DSC TX deviation, - at 1.3K:	2.6 ± 0.26 KHz
- at 2.1K:	4.2 ± 0.42 KHz
ATIS TX deviation, - at 1.3 KHz:	1.3 ± 0.13 KHz
- at 2.1 KHz:	2.1 ± 0.21 KHz

RECEIVER

12dB SINAD sensitivity:	0.25 μ V (distant) / 0.8 μ V (local)
20db SINAD sensitivity:	0.35 μ V
Adjacent CH selectivity:	more than 70 db
Spurious response:	more than 70 db
Intermodulation rejection:	more than 68 db
Residual noise level:	more than -40 db unscquelched
Audio output power:	2 W (with 8 ohm at 10% distortion) 4 W (with 4 ohm external speaker)

BUILT-IN GPS RECEIVER

Receiving frequency:	1575.42 MHz
Tracking code:	C/A code
Number of channels:	72 channels
Horizontal accuracy:	<10 m
Position fixing time:	Warm start: 30s, Cold start: 90s
Position update interval:	1 second typical

HAILER

Audio power out:	30 W @ 4 Ohms
------------------	---------------

AIS

AIS function:	Yes, dual receivers (receive only)
Receiver frequency:	161.975 MHz (CH87) & 162.025 MHz (CH88)
Supported AIS information:	Status; Destination; ETA; Vessel Name; Type of vessel; Call sign; MMSI number; IMO number; Draft/Size of vessel; Vessel position; SOG/COG/Rate of turn/Heading
AIS targets:	Maximum 150

V60 WIRELESS SPECIFICATIONS

Wireless standard:	802.11 b/g/n20
Operating frequency:	2412~2472 MHz (for EU); 2412-2462 MHz (for US)
Rx Sensitivity (802.11 b - 11 Mbps):	-86 dBm (+/-2)
Tx Power (802.11 b - 11 Mbps):	9.89 dBm (Declaration for EU Compliance)
Functional range (base station -> handset):	100 m (direct line of sight, no obstructions)

H60 WIRELESS HANDSET

Wireless standard:	802.11 b/g/n20
Operating frequency:	2412~2472 MHz (for EU); 2412-2462 MHz (for US)
Rx Sensitivity (802.11 b - 11 Mbps):	-86 dBm (+/-2)
Tx Power (802.11 b - 11 Mbps):	9.81 dBm (Declaration for EU Compliance)
LCD display:	FSTN 256x160 pixels, monochrome
Battery (internal):	Li-Ion (lithium Ion); 3.6 V 2050 mAh (5.1 Wh)
Charging system:	Inductive charging when set on cradle charger (BC-12)
Functional range, handset -> base station:	90 m (direct line of sight, no obstructions)
Environmental:	IPx7

HANDSET CRADLE CHARGER (BC-12)

H60 cradle charger voltage:	12 V DC battery system (negative ground)
H60 cradle charger DC current drain:	≤0.5 A
Charger operating frequency:	131.125 KHz-176.600 KHz
Charger max. RF power:	-10.88 dB μ A/m @ 10 m
Environmental:	IPx7

ACCESSORIES

VHF Radio Antenna:	Type: Dipole Gain value: 6 dBi
--------------------	-----------------------------------

→ **Note:** Specifications are subject to change without notice.

11

Channel charts

The following channel charts are provided for reference only and may not be correct for all regions. It is the operators responsibility to ensure correct channels and frequencies are used for local regulations.

EU and INTERNATIONAL channel chart

The following is a table of transmitting frequencies in the VHF maritime mobile band.

- **Note:** For assistance in understanding the Table, see Notes a) to zz) below. (WRC-15)
- **Note:** The Table below defines the channel numbering for maritime VHF communications based on 25 kHz channel spacing and use of several duplex channels. The channel numbering and the conversion of two-frequency channels for single-frequency operation shall be in accordance with Recommendation ITU-R M.1084-5 Annex 4, Tables 1 and 3. The Table below also describes the harmonized channels where the digital technologies defined in the most recent version of Recommendation ITU-R M.1842 could be deployed. (WRC-15)

Channel designator	Transmitting frequencies (MHz)		S/D/R	Channel name	Restriction	Notes
	From ship stations	From coast stations				
01	156.050	160.650	D	TELEPHONE		m)
02	156.100	160.700	D	TELEPHONE		m)
03	156.150	160.750	D	TELEPHONE		m)
04	156.200	160.800	D	PORT OPS		m)
05	156.250	160.850	D	PORT OPS/ VTS		m)
06	156.300	156.300	S	SAFETY		f)
07	156.350	160.950	D	PORT OPS		m)
08	156.400	156.400	S	COMMERCIAL		
09	156.450	156.450	S	CALLING		i)
10	156.500	156.500	S	COMMERCIAL		h), q)
11	156.550	156.550	S	VTS		q)
12	156.600	156.600	S	PORT OPS/ VTS		
13	156.650	156.650	S	BRIDGE COM		k)
14	156.700	156.700	S	PORT OPS/ VTS		
15	156.750	156.750	S	PORT OPS	1W	g)
16	156.800	156.800	S	DISTRESS		f)
17	156.850	156.850	S	SAR	1W	g)
18	156.900	161.500	D	PORT OPS		m)
19	156.950	161.550	D	SHIP-SHORE		t), u), v)
20	157.000	161.600	D	PORT OPS		t), u), v)
21	157.050	161.650	D	PORT OPS		w), y)
22	157.100	161.700	D	PORT OPS		w), y)
23	157.150	161.750	D	TELEPHONE		w), x), y)
24	157.200	161.800	D	TELEPHONE		w), ww), x), y)
25	157.250	161.850	D	TELEPHONE		w), ww), x), y)
26	157.300	161.900	D	TELEPHONE		w), ww), x), y)
27	157.350	161.950	D	TELEPHONE		z)
28	157.400	162.000	D	TELEPHONE		z)
60	156.025	160.625	D	TELEPHONE		m)
61	156.075	160.675	D	PORT OPS		m)
62	156.125	160.725	D	PORT OPS		m)
63	156.175	160.775	D	PORT OPS		m)
64	156.225	160.825	D	TELEPHONE		m)
65	156.275	160.875	D	PORT OPS		m)
66	156.325	160.925	D	PORT OPS		m)
67	156.375	156.375	S	BRIDGE COM		h)
68	156.425	156.425	S	SHIP-SHIP		

69	156.475	156.475	S	PORT OPS		
71	156.575	156.575	S	PORT OPS		
72	156.625	156.625	S	SHIP-SHIP		i)
73	156.675	156.675	S	PORT OPS		h), i)
74	156.725	156.725	S	PORT OPS		
75	156.775	156.775	S	PORT OPS	1W	n), s)
76	156.825	156.825	S	SHIP-SHIP	1W	n), s)
77	156.875	156.875	S	SHIP-SHIP		
78	156.925	161.525	D	SHIP-SHORE		t), u), v)
79	156.975	161.575	D	PORT OPS		t), u), v)
80	157.025	161.625	D	PORT OPS		w), y)
81	157.075	161.675	D	TELEPHONE		w), y)
82	157.125	161.725	D	TELEPHONE		w), x), y)
83	157.175	161.775	D	TELEPHONE		w), x), y)
84	157.225	161.825	D	TELEPHONE		w), ww), x), y)
85	157.275	161.875	D	TELEPHONE		w), ww), x), y)
86	157.325	161.925	D	TELEPHONE		w), ww), x), y)
87	157.375	157.375	S	TELEPHONE		z)
88	157.425	157.425	S	TELEPHONE		z)
1019	156.950	156.950	S	TELEPHONE		
1020	157.000	157.000	S	TELEPHONE		
1078	156.925	156.925	S	TELEPHONE		
1079	156.975	156.975	S	TELEPHONE		
2006	160.900	160.900	S	TELEPHONE		r)
2019	161.550	161.550	S	TELEPHONE		
2020	161.600	161.600	S	TELEPHONE		
2078	161.525	161.525	S	TELEPHONE		
2079	161.575	161.575	S	TELEPHONE		

Editorial note: The note numbering below is provisional and will be aligned during final preparations of the new edition of the Radio Regulations.

Notes referring to the Table

General notes:

- a) Administrations may designate frequencies in the inter-ship, port operations and ship movement services for use by light aircraft and helicopters to communicate with ships or participating coast stations in predominantly maritime support operations under the conditions specified in Nos. **51.69, 51.73, 51.74, 51.75, 51.76, 51.77** and **51.78**. However, the use of the channels which are shared with

public correspondence shall be subject to prior agreement between interested and affected administrations.

- b) The channels of the present Appendix, with the exception of channels 06, 13, 15, 16, 17, 70, 75 and 76, may also be used for high-speed data and facsimile transmissions, subject to special arrangement between interested and affected administrations.
- c) The channels of the present Appendix, with the exception of channels 06, 13, 15, 16, 17, 70, 75 and 76, may be used for direct-printing telegraphy and data transmission, subject to special arrangement between interested and affected administrations. (WRC-12)
- d) The frequencies in this table may also be used for radio communications on inland waterways in accordance with the conditions specified in No. **5.226**.
- e) Administrations may apply 12.5 kHz channel interleaving on a non-interference basis to 25 kHz channels, in accordance with the most recent version of Recommendation ITU-R M.1084, provided:
 - it shall not affect the 25 kHz channels of the present Appendix maritime mobile distress and safety, automatic identification system (AIS), and data exchange frequencies, especially the channels 06, 13, 15, 16, 17, 70, AIS 1 and AIS 2, nor the technical characteristics set forth in Recommendation ITU-R M.489-2 for those channels;
 - implementation of 12.5 kHz channel interleaving and consequential national requirements shall be subject to coordination with affected administrations. (WRC-12)

Specific notes

- f) The frequencies 156.300 MHz (channel 06), 156.525 MHz (channel 70), 156.800 MHz (channel 16), 161.975 MHz (AIS 1) and 162.025 MHz (AIS 2) may also be used by aircraft stations for the purpose of search and rescue operations and other safety-related communication. (WRC-07)
- g) Channels 15 and 17 may also be used for on-board communications provided the effective radiated power does not exceed 1W, and subject to the national regulations of the administration concerned when these channels are used in its territorial waters.
- h) Within the European Maritime Area and in Canada, these frequencies (channels 10, 67, 73) may also be used, if so required, by the individual administrations concerned, for communication between ship stations, aircraft stations and participating land stations engaged in coordinated search and rescue and anti-

pollution operations in local areas, under the conditions specified in Nos. **51.69, 51.73, 51.74, 51.75, 51.76, 51.77** and **51.78**.

- i) The preferred first three frequencies for the purpose indicated in Note **a)** are 156.450 MHz (channel 09), 156.625 MHz (channel 72) and 156.675 MHz (channel 73).
- j) Channel 70 is to be used exclusively for digital selective calling for distress, safety and calling.
- k) Channel 13 is designated for use on a worldwide basis as a navigation safety communication channel, primarily for intership navigation safety communications. It may also be used for the ship movement and port operations service subject to the national regulations of the administrations concerned.
- l) These channels (AIS 1 and AIS 2) are used for an automatic identification system (AIS) capable of providing world wide operation, unless other frequencies are designated on a regional basis for this purpose. Such use should be in accordance with the most recent version of Recommendation ITU-RM.1371. (WRC-07)
- m) These channels may be operated as single frequency channels, subject to coordination with affected administrations. The following conditions apply for single frequency usage:
 - The lower frequency portion of these channels may be operated as single frequency channels by ship and coast stations.
 - Transmission using the upper frequency portion of these channels is limited to coast stations.
 - If permitted by administrations and specified by national regulations, the upper frequency portion of these channels may be used by ship stations for transmission. All precautions should be taken to avoid harmful interference to channels AIS 1, AIS 2, 2027* and 2028*. (WRC-15)
 - * From 1 January 2019, channel 2027 will be designated ASM 1 and channel 2028 will be designated ASM 2.
- n) With the exception of AIS, the use of these channels (75 and 76) should be restricted to navigation-related communications only and all precautions should be taken to avoid harmful interference to channel 16, by limiting the output power to 1W. (WRC-12)
- o) (SUP - WRC-12)
- p) Additionally, AIS 1 and AIS 2 may be used by the mobile-satellite service (Earth-to-space) for the reception of AIS transmissions from ships. (WRC-07)
- q) When using these channels (10 and 11), all precautions should be taken to avoid harmful interference to channel 70. (WRC-07)

- r) In the maritime mobile service, this frequency is reserved for experimental use for future applications or systems (e.g. new AIS applications, man over board systems, etc.). If authorized by administrations for experimental use, the operation shall not cause harmful interference to, or claim protection from, stations operating in the fixed and mobile services. (WRC-12)
- s) Channels 75 and 76 are also allocated to the mobile-satellite service (Earth-to-space) for the reception of long-range AIS broadcast messages from ships (Message 27; see the most recent version of Recommendation ITU-RM.1371). (WRC-12)
- w. In Regions 1 and 3:
- Until 1 January 2017, the frequency bands 157.200-157.325 MHz and 161.800-161.925 MHz (corresponding to channels: 24, 84, 25, 85, 26 and 86) may be used for digitally modulated emissions, subject to coordination with affected administrations. Stations using these channels or frequency bands for digitally modulated emissions shall not cause harmful interference to, or claim protection from, other stations operating in accordance with Article 5.
- From 1 January 2017, the frequency bands 157.200-157.325 MHz and 161.800-161.925 MHz (corresponding to channels: 24, 84, 25, 85, 26 and 86) are identified for the utilization of the VHF Data Exchange System (VDDES) described in the most recent version of Recommendation ITU-R M.2092. These frequency bands may also be used for analogue modulation described in the most recent version of Recommendation ITU-R M.1084 by an administration that wishes to do so, subject to not causing harmful interference to, or claiming protection from other stations in the maritime mobile service using digitally modulated emissions and subject to coordination with affected administrations. (WRC-15)
- ww. In Region 2, the frequency bands 157.200-157.325 and 161.800-161.925 MHz (corresponding to channels: 24, 84, 25, 85, 26 and 86) are designated for digitally modulated emissions in accordance with the most recent version of Recommendation ITU-R M.1842.
- In Canada and Barbados, from 1 January 2019 the frequency bands 157.200-157.275 and 161.800-161.875 MHz (corresponding to channels: 24, 84, 25 and 85) may be used for digitally modulated emissions, such as those described in the most recent version of Recommendation ITU-R M.2092, subject to coordination with affected administrations. (WRC-15)
- x) From 1 January 2017, in Angola, Botswana, Lesotho, Madagascar, Malawi, Mauritius, Mozambique, Namibia, Democratic Republic of the Congo, Seychelles, South Africa, Swaziland, Tanzania, Zambia

and Zimbabwe, the frequency bands 157.125-157.325 and 161.725-161.925 MHz (corresponding to channels: 82, 23, 83, 24, 84, 25, 85, 26 and 86) are designated for digitally modulated emissions.

From 1 January 2017, in China, the frequency bands 157.150 - 157.325 and 161.750 - 161.925 MHz (corresponding to channels: 23, 83, 24, 84, 25, 85, 26 and 86) are designated for digitally modulated emissions. (WRC-12)

- y) These channels may be operated as single or duplex frequency channels, subject to coordination with affected administrations. (WRC-12)
- z) Until 1 January 2019, these channels maybe used for possible testing of future AIS applications without causing harmful interference to, or claiming protection from, existing applications and stations operating in the fixed and mobile services.

From 1 January 2019, these channels are each split into two simplex channels. The channels 2027 and 2028 designated as ASM 1 and ASM 2 are used for application specific messages (ASM) as described in the most recent version of Recommendation ITU-R M.2092. (WRC-15)

AAA) From 1 January 2019, the channels 24, 84, 25 and 85 may be merged in order to form a unique duplex channel with a bandwidth of 100 kHz in order to operate the VDES terrestrial component described in the most recent version of Recommendation ITU-RM.2092. (WRC-15)

mm) Transmission on these channels is limited to coast stations. If permitted by administrations and specified by national regulations, these channels may be used by ship stations for transmission. All precautions should be taken to avoid harmful interference to channels AIS 1, AIS 2, 2027* and 2028*. (WRC-15)

* From 1 January 2019, channel 2027 will be designated ASM 1 and channel 2028 will be designated ASM 2.

w1) In Regions 1 and 3:

Until 1 January 2017, the frequency bands 157.025-157.175 MHz and 161.625-161.775 MHz (corresponding to channels: 80, 21, 81, 22, 82, 23 and 83) may be used for digitally modulated emissions, subject to coordination with affected administrations. Stations using these channels or frequency bands for digitally modulated emissions shall not cause harmful interference to, or claim protection from, other stations operating in accordance with Article 5.

From 1 January 2017, the frequency bands 157.025-157.100 MHz and 161.625-161.700 MHz (corresponding to channels: 80, 21, 81 and 22) are identified for utilization of the digital systems described

in the most recent version of Recommendation ITU-R M.1842 using multiple 25 kHz contiguous channels.

From 1 January 2017, the frequency bands 157.150-157.175 MHz and 161.750-161.775 MHz (corresponding to channels: 23 and 83) are identified for utilization of the digital systems described in the most recent version of Recommendation ITU-R M.1842 using two 25 kHz contiguous channels. From 1 January 2017, the frequencies 157.125 MHz and 161.725 MHz (corresponding to channel: 82) are identified for the utilization of the digital systems described in the most recent version of Recommendation ITU-R M.1842.

The frequency bands 157.025-157.175 MHz and 161.625-161.775 MHz (corresponding to channels: 80, 21, 81, 22, 82, 23 and 83) can also be used for analogue modulation described in the most recent version of Recommendation ITU-R M.1084 by an administration that wishes to do so, subject to not claiming protection from other stations in the maritime mobile service using digitally modulated emissions and subject to coordination with affected administrations. (WRC-15)

- zx)** In the United States, these channels are used for communication between ship stations and coast stations for the purpose of public correspondence. (WRC-15)
- zz)** From 1 January 2019, channels 1027, 1028, 87 and 88 are used as single-frequency analogue channels for port operation and ship movement. (WRC-15)

Source: ITU Radio Regulations (2016); reproduced with permission from ITU

USA channel chart

Channel designator	Transmitting frequencies (MHz)		S/D/R	Channel name	Restrictions
	From ship stations	From coast stations			
6	156.300	156.300	S	SAFETY	
8	156.400	156.400	S	COMMERCIAL	
9	156.450	156.450	S	CALLING	
10	156.500	156.500	S	COMMERCIAL	
11	156.550	156.550	S	VTS	
12	156.600	156.600	S	PORT OPS/VTS	
13	156.650	156.650	S	BRIDGE COM	1W
14	156.700	156.700	S	PORT OPS/VTS	
15	--	156.750	R	ENVIROMENTAL	RX ONLY
16	156.800	156.800	S	DISTRESS	
17	156.850	156.850	S	SAR	1W
20	157.000	161.600	D	PORT OPS	
24	157.200	161.800	D	TELEPHONE	
25	157.250	161.850	D	TELEPHONE	
26	157.300	161.900	D	TELEPHONE	
27	157.350	161.950	D	TELEPHONE	
28	157.400	162.000	D	TELEPHONE	
67	156.375	156.375	S	BRIDGE COM	1W
68	156.425	156.425	S	SHIP-SHIP	
69	156.475	156.475	S	SHIP-SHIP	
71	156.575	156.575	S	SHIP-SHIP	
72	156.625	156.625	S	SHIP-SHIP	
73	156.675	156.675	S	PORT OPS	
74	156.725	156.725	S	PORT OPS	
75	156.775	156.775	S	PORT OPS	1W
76	156.825	156.825	S	PORT OPS	1W
77	156.875	156.875	S	PORT OPS	1W
84	157.225	161.825	D	TELEPHONE	
85	157.275	161.875	D	TELEPHONE	
86	157.325	161.925	D	TELEPHONE	
87	157.375	157.375	S	TELEPHONE	
88	157.425	157.425	S	INTER-SHIP	
1001	156.050	156.050	S	PORT OPS/VTS	
1005	156.250	156.250	S	PORT OPS/VTS	

1007	156.350	156.350	S	COMMERCIAL	
1018	156.900	156.900	S	COMMERCIAL	
1019	156.950	156.950	S	COMMERCIAL	
1020	157.000	157.000	S	PORT OPS	
1021	157.050	157.050	S	US COAST GRD	
1022	157.100	157.100	S	US COAST GRD	
1023	157.150	157.150	S	US COAST GRD	
1063	156.175	156.175	S	PORT OPS/VTS	
1065	156.275	156.275	S	PORT OPS	
1066	156.325	156.325	S	PORT OPS	
1078	156.925	156.925	S	SHIP-SHIP	
1079	156.975	156.975	S	COMMERCIAL	
1080	157.025	157.025	S	COMMERCIAL	
1081	157.075	157.075	S	RESTRICTED	
1082	157.125	157.125	S	RESTRICTED	
1083	157.175	157.175	S	RESTRICTED	

USA weather channels

Channel designator	Transmitting frequencies (MHz)		S/D/R	Channel name	Restrictions
	From ship stations	From coast stations			
WX1	--	162.550	R	NOAA WX1	RX ONLY
WX2	--	162.400	R	NOAA WX2	RX ONLY
WX3	--	162.475	R	NOAA WX3	RX ONLY
WX4	--	162.425	R	NOAA WX4	RX ONLY
WX5	--	162.450	R	NOAA WX5	RX ONLY
WX6	--	162.500	R	NOAA WX6	RX ONLY
WX7	--	162.525	R	NOAA WX7	RX ONLY

CANADA channel chart

Channel designator	Frequencies			Channel Name:	RESTRICTIONS
	MHz (ship)	MHz (coast)	S/D/R		
1	156.050	160.650	D	TELEPHONE	
2	156.100	160.700	D	TELEPHONE	
3	156.150	160.750	D	TELEPHONE	
4	156.200	160.800	D	CANADIAN CG	
5	156.250	160.850	D	TELEPHONE	
6	156.300	156.300	S	SAFETY	
7	156.350	160.950	D	TELEPHONE	
8	156.400	156.400	S	COMMERCIAL	
9	156.450	156.450	S	VTS	
10	156.500	156.500	S	VTS	
11	156.550	156.550	S	VTS	
12	156.600	156.600	S	PORT OPS/VTS	
13	156.650	156.650	S	BRIDGE COM	1W
14	156.700	156.700	S	PORT OPS/VTS	
15	156.750	156.750	S	COMMERCIAL	1W
16	156.800	156.800	S	DISTRESS	
17	156.850	156.850	S	SAR	1W
18	156.900	161.500	D	TELEPHONE	
19	156.950	161.550	D	CANADIAN CG	
20	157.000	161.600	D	CANADIAN CG	1W
21	157.050	161.650	D	CANADIAN CG	
22	157.100	161.700	D	TELEPHONE	
23	157.150	161.750	D	TELEPHONE	
24	157.200	161.800	D	TELEPHONE	
25	157.250	161.850	D	TELEPHONE	
26	157.300	161.900	D	TELEPHONE	
27	157.350	161.950	D	TELEPHONE	
28	157.400	162.000	D	TELEPHONE	
60	156.025	160.625	D	TELEPHONE	
61	156.075	160.675	D	CANADIAN CG	
62	156.125	160.725	D	CANADIAN CG	
63	156.175	160.775	D	TELEPHONE	
64	156.225	160.825	D	TELEPHONE	
65	156.275	160.875	D	TELEPHONE	

66	156.325	160.925	D	TELEPHONE	
67	156.375	156.375	S	COMMERCIAL	
68	156.425	156.425	S	SHIP-SHIP	
69	156.475	156.475	S	COMMERCIAL	
71	156.575	156.575	S	VTS	
72	156.625	156.625	S	SHIP-SHIP	
73	156.675	156.675	S	COMMERCIAL	
74	156.725	156.725	S	VTS	
75	156.775	156.775	S	PORT OPS	1W
76	156.825	156.825	S	PORT OPS	1W
77	156.875	156.875	S	PORT OPS	1W
78	156.925	161.525	D	TELEPHONE	
79	156.975	161.575	D	TELEPHONE	
80	157.025	161.625	D	TELEPHONE	
81	157.075	161.675	D	TELEPHONE	
82	157.125	161.725	D	CANADIAN CG	
83	157.175	161.775	D	CANADIAN CG	
84	157.225	161.825	D	TELEPHONE	
85	157.275	161.875	D	TELEPHONE	
86	157.325	161.925	D	TELEPHONE	
87	157.375	157.375	S	PORT OPS	
88	157.425	157.425	S	PORT OPS	
1001	156.050	156.050	S	COMMERCIAL	
1005	156.250	156.250	S	PORT OPS/VTS	
1007	156.350	156.350	S	COMMERCIAL	
1018	156.900	156.900	S	COMMERCIAL	
1019	156.950	156.950	S	CANADIAN CG	
1020	157.000	157.000	S	PORT OPS	
1021	157.050	157.050	S	RESTRICTED	
1022	157.100	157.100	S	CANADIAN CG	
1024	157.200	157.200	S	PORT OPS	
1025	157.250	157.250	S	PORT OPS	
1026	157.300	157.300	S	PORT OPS	
1027	157.350	157.350	S	CANADIAN CG	
1061	156.075	156.075	S	CANADIAN CG	
1062	156.125	156.125	S	CANADIAN CG	
1063	156.175	156.175	S	TELEPHONE	

1064	156.225	156.225	S	RESTRICTED	
1065	156.275	156.275	S	PORT OPS	
1066	156.325	156.325	S	PORT OPS	
1078	156.925	156.925	S	SHIP-SHIP	
1079	156.975	156.975	S	COMMERCIAL	
1080	157.025	157.025	S	COMMERCIAL	
1083	157.175	157.175	S	RESTRICTED	
1084	157.225	157.225	S	PORT OPS	
1085	157.275	157.275	S	CANADIAN CG	
1086	157.325	157.325	S	PORT OPS	
2019	--	161.550	R	PORT OPS	RX ONLY
2020	--	161.600	R	PORT OPS	RX ONLY
2023	--	161.750	R	SAFETY	RX ONLY
2026	--	161.900	R	PORT OPS	RX ONLY
2078	--	161.525	R	PORT OPS	RX ONLY
2079	--	161.575	R	PORT OPS	RX ONLY
2086	--	161.925	R	PORT OPS	RX ONLY

Canada weather channels

Channel designator	Transmitting frequencies (MHz)		S/D/R	Channel name	Restrictions
	From ship stations	From coast stations			
WX1	--	162.550	R	CANADA WX	Rx only
WX2	--	162.400	R	CANADA WX	Rx only
WX3	--	162.475	R	CANADA WX	Rx only

12

Dimensional drawings

V60 fixed mount VHF

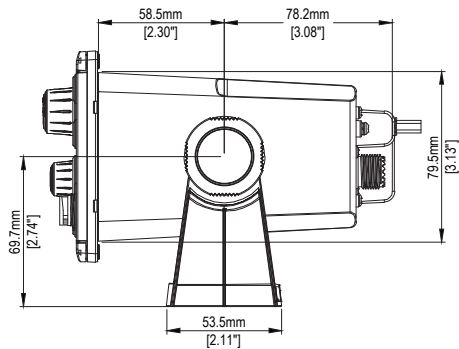
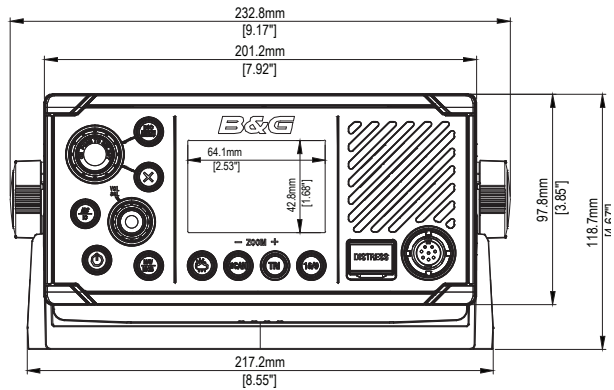
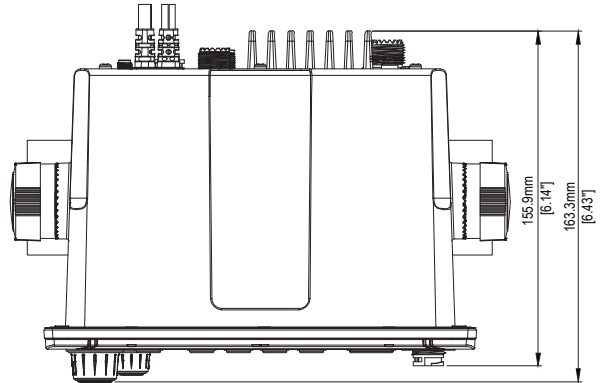

V60 hand mic

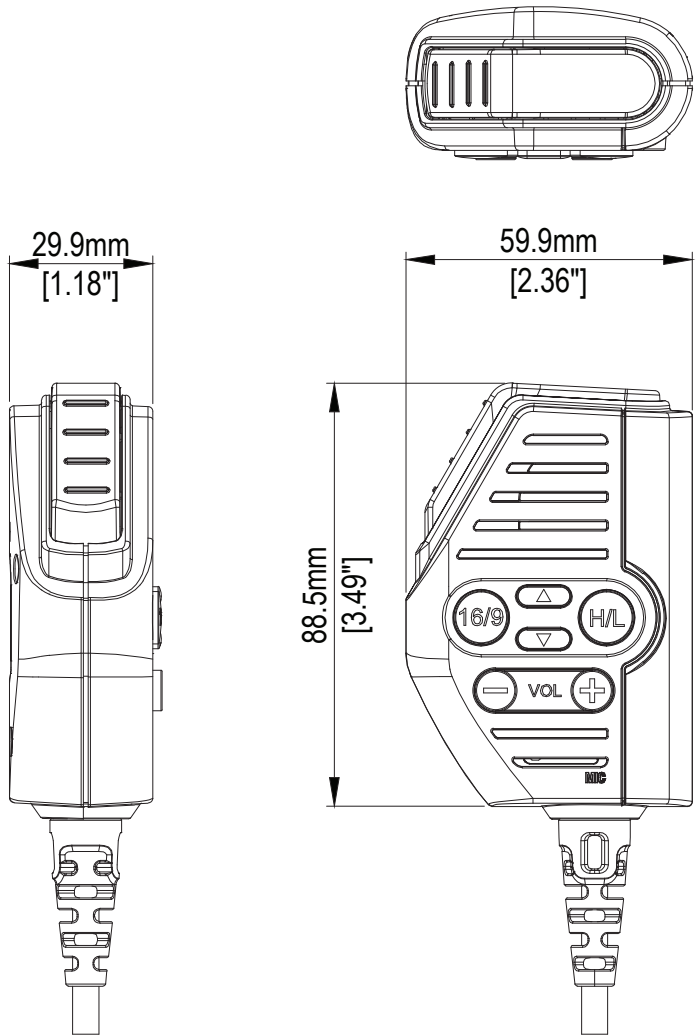

Handset Cradle Charger (BC-12)

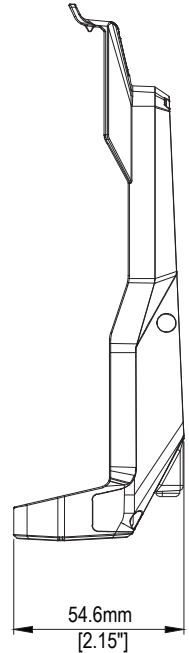
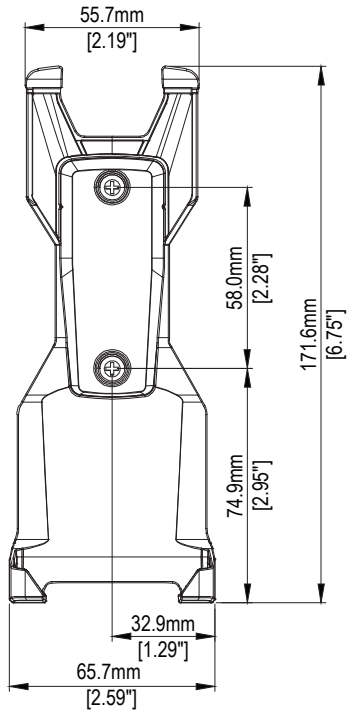
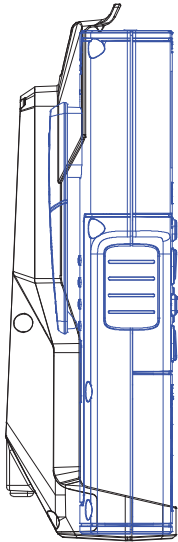
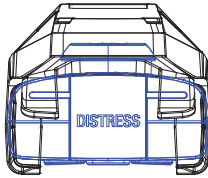

H60 wireless handset

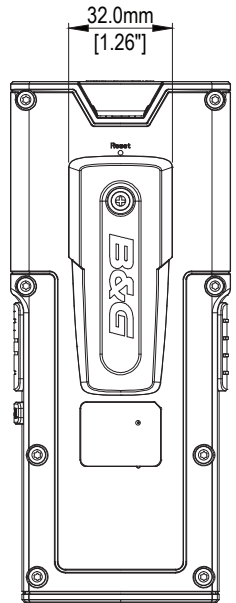
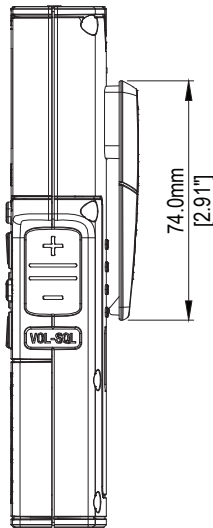
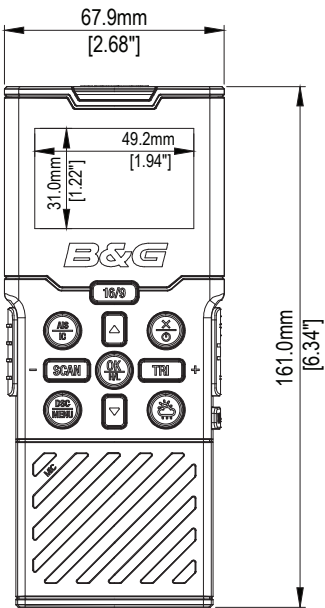

13

NMEA 2000 compliant PGN list

PGN	Description	RX	TX
59392	ISO Acknowledgement	•	•
59904	ISO Request	•	•
60928	ISO Address Claim	•	•
126208	NMEA — Group Function	•	•
126464	PGN List		•
126993	Heartbeat		•
126996	Product Information	•	•
126998	Configuration Information		•
127258	Magnetic Variation	•	
129026	COG & SOG, Rapid Update	•	◇
129029	GNSS Position Data	•	◇
129044	Datum	•	
129540	GNSS Sats in View		◇
129799	Radio Frequency/Mode/Power		•
129808	DSC Call Information		•
129283	Cross Track Error		•
129284	Navigation Data		•
130074	Route and WP Service - WP List -WP Name & Position		•
127233	MOB Data		•
129038	AIS Class A Position Report		•
129039	AIS Class B Position Report		•
129040	AIS Class B Extended Position Report		•
129041	AIS Aids to Navigation (AtoN) Report		•
129793	AIS UTC and Date Report		•
129794	AIS Class A Static and Voyage Related Data		•
129797	AIS Binary Broadcast Message		•
129798	AIS SAR Aircraft Position Report		•
129801	AIS Addressed Safety Message		•
129802	AIS Safety Related Broadcast Message		•
129809	AIS Class B CS Static Data Report, Part A		•
129810	AIS Class B CS Static Data Report, Part B		•
130845	Parameter Handle	•	•
130850	Event Command	•	
130851	Event Reply		•

◇) Only if GPS source = INTERNAL



B&G