

PHILIPS

Wireless Speaker

TAS7505

User manual



Register your product and get support at
www.philips.com/support

Contents

1	Important	2
	Safety	2

2	Your wireless speaker	3
	Introduction	3
	What's in the box	3
	Overview of the speaker	3

3	Get started	4
	Charge the built-in battery	4
	Turn on/off	4

4	Play from Bluetooth devices	5
	Play from Bluetooth devices	5
	Control playback	5
	Pairing for stereo mode	5

5	Product information	7
----------	----------------------------	----------

6	Troubleshooting	8
	General	8
	Bluetooth	8

7	Notice	9
	Compliance	9
	Care of the environment	9
	FCC Statement	9
	Trademark notice	10

1 Important

Safety

Important safety instructions

- Make sure that the power supply voltage corresponds to the voltage on the back or the underside of the unit.
- The speaker shall not be exposed to dripping or splashing.
- Do not place any source of danger on the speaker (e.g. liquid filled objects, lit candles).
- Make sure that there is enough free space around the speaker for ventilation.
- Please use the speaker safely in an environment with temperature between 0° and 45°.
- Only use attachments and accessories specified by the manufacturer:

Battery safety precautions

- Danger of explosion if a battery is incorrectly replaced. Replace only with the same or equivalent type.
- A battery (battery pack or battery installed) shall not be exposed to excessive heat such as sunshine, fire or the like.
- A battery in extreme high or low temperatures during use, storage or transportation, and low air pressure at high altitude can pose safety hazards.
- Do not replace a battery with an incorrect type that can defeat a safeguard (for example, some lithium battery types).

- Disposing a battery into fire or a hot oven mechanically crushing or cutting a battery can result in an explosion.
- Leaving a battery in an extremely high temperature surrounding, or an extremely low air pressure environment may result in an explosion or leakage of flammable liquid or gas.



Warning

- Never remove the casing of this speaker.
- Never lubricate any part of this speaker.
- Place this speaker on a flat, hard and stable surface.
- Never place this speaker on other electrical equipment.
- Only use this speaker indoors. Keep this speaker away from water, moisture and liquid-filled objects.
- Keep this speaker away from direct sunlight, naked flames or heat.
- Risk of explosion if a battery is replaced by an incorrect type.

2 Your wireless speaker

Congratulations on your purchase, and welcome to Philips! To fully benefit from the support that Philips offers, register your product at www.philips.com/welcome.

Introduction

With this speaker, you can enjoy audio from Bluetooth-enabled devices.







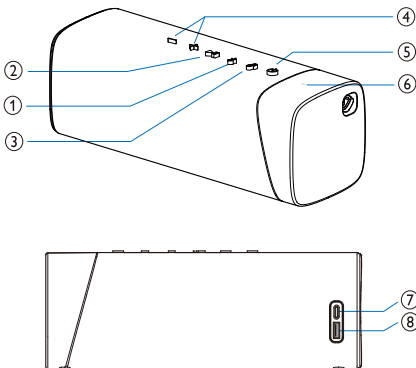

What's in the box

Check and identify the contents of your package:

- Speaker
- USB cable
- Quick start guide
- Safety sheet
- Worldwide warranty

Overview of the speaker



- ① 
 - Enter Bluetooth pairing mode.
 - Clear Bluetooth pairing information.
- ② 
 - In Bluetooth mode, press to pause or resume play.
 - In Bluetooth mode, press twice to play the next track..
- ③ 
 - Press and hold to enter stereo pairing mode.
 - It only works when you have two identical Philips S7505 BT speakers.
- ④ 
 - Adjust volume.
- ⑤ 
 - Turn the speaker on or off.
 - Show the Bluetooth status.
- ⑥ **LED indicator**
 - Check the battery level.
 - To check battery status, press any other keys but not , as  will trigger the power off.
- ⑦ 
 - Charge the built-in battery.
- ⑧ 
 - Charge an external device.

3 Get started

Always follow the instructions in this chapter in sequence.

Charge the built-in battery

The speaker is powered by a built-in rechargeable battery.

Note

- Fully charge the built-in battery before using.
- When the speaker is turned on and the battery is low, the battery level LED indicator blinks red.

Connect the USB-C socket on the speaker to an outlet (5V \Rightarrow 2A) by using the provided USB cable.

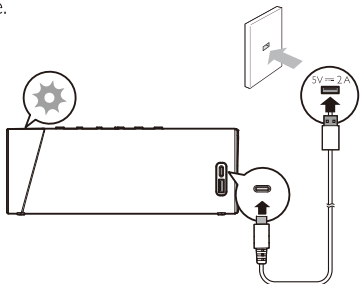

- ↳ When the speaker is being charged, the battery level LED indicator blinks red and white alternately.
- ↳ When the speaker is fully charged, the battery level LED indicator lights off.
- ↳ Press any key to check battery level. The LED shows the charging status.

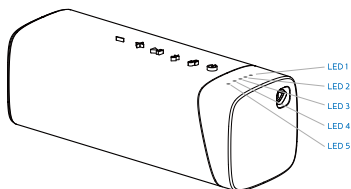

Battery power	LED 1	LED 2	LED 3	LED 4	LED 5
Full	Solid White				
>80%	Solid White			OFF	
50-80%	Solid White			OFF	
20-50%	Solid White		OFF		
<20%	OFF	Blinking RED	OFF		

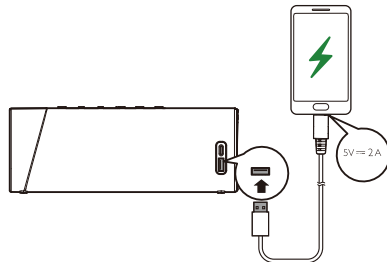

- ↳ The speaker could charge an external device via USB cable.

! Caution

- Risk of speaker damage! Make sure the power supply voltage corresponds to the voltage printed on the back or the underside of the speaker.
- Risk of electric shock! When unplug the USB cable, always pull the plug from the socket. Never pull the cable.
- Use only a USB cable specified by the manufacturer or sold with this speaker.

Turn on/off

Press  to turn the speaker on.

- ↳ You will hear the prompt sound.
- ↳ It will enter Bluetooth pairing mode automatically, and the LED indicator will blink white.

To turn the speaker off, press  again.

Note

- The speaker will turn off automatically after 15 minutes without connection from Bluetooth.

4 Play from Bluetooth devices

Play from Bluetooth devices

With this speaker, you can enjoy audio from your Bluetooth device.



Note

- Make sure that the Bluetooth function is enabled on your device.
- The maximum distance for pairing the speaker and your Bluetooth device is 20 meters (66 feet).
- Keep away from any other electronic device that may cause interference.

- 1 Press  to turn the speaker on, it will enter Bluetooth pairing mode automatically.
- 2 Enable Bluetooth and select "Philips S7505" in the Bluetooth list on your device for pairing.
- 3 Play audio on your Bluetooth device to start streaming music.



LED indicator	Description
Blinking white slowly	Ready for pairing
Blinking white slowly	Reconnecting the last connected device
Solid white	Connected

Note

- To disconnect a device, press and hold  for 2 seconds until the LED indicator blinks White quickly.
- When you turn on the speaker, it always automatically tries to reconnect the last successfully connected device.
- To clear the pairing information, press and hold  for 2 seconds until the LED indicator slowly blinks white for 3 times.

Control playback

During playing the music,



-  Press to pause or resume play
-  Press twice to play the next track
-  Adjust the volume

Pairing for stereo mode

Two identical wireless speakers (Philips S7505) can pair with each other for stereo sound.

Note

- Before stereo pairing, make sure that the secondary speaker is under Bluetooth pairing mode.
- The maximum distance for pairing the speaker and your Bluetooth device is 20 meters (66 feet).
- In stereo mode, the button operation on the secondary speaker is as same as that of the primary speaker.

- 1 Press  to power on both speakers, they will enter Bluetooth pairing mode automatically. Press and hold  to enter stereo pairing mode until the LED indicator blinks red and white alternately.
 - ↳ You will hear a prompt sound when successfully connected.
 - ↳ The LED indicator is solid white on the secondary speaker.
- 2 Press  on either speaker. The music will be played through both speakers.

To exit the stereo mode, press and hold the  on either speaker.

5 Product information



Note

- Product information is subject to change without prior notice.

General information

Power supply:	5V ---2A
Built-in Lithium battery	3.7V, 7500mAh
Dimensions (W x H x D)	231x87x85mm
Weight (main unit)	0.86kg
IP protection class	IPX7 *

*The IPX7 rating means the speaker driver can be submerged for up to 30 minutes at a depth of up to 1 m. The speaker fabric is not waterproof, but the wool-blend material can withstand a drop of water.

Amplifier

Output power	30W
Frequency response	20 - 20000 Hz
Signal to noise ratio	> 70db

Speakers

Impedance	3
Maximum input power	30W
Size	50x90mm

Bluetooth

Bluetooth version	5.0
Frequency range	2402-2480MHZ
Maximum transmission power	8±2dBm
Compatible Bluetooth profiles	A2DP,AVRCP
Bluetooth range	approx.20m

6 Troubleshooting



Warning

- Never remove the casing of the speaker.

To keep the warranty valid, never try to repair the speaker yourself.

If you encounter problems when using this speaker, check the following points before requesting service. If the problem remains unsolved, go to the Philips website (www.philips.com/support). When you contact Philips, ensure that the speaker is nearby and the model number and serial number are available.

General

No power

- Make sure the speaker is fully charged.
- Make sure the USB socket of the speaker is properly connected.
- As a power-saving feature, the speaker turns off automatically 15 minutes after no audio signal is received or no audio device is connected.

No sound

- Adjust the volume on this speaker.
- Adjust the volume on the connected device.
- Make sure that your Bluetooth device is within the operational range.

No response from the speaker

- Restart the speaker.

Bluetooth

The audio quality is poor after connection with a Bluetooth-enabled device

- The Bluetooth reception is poor. Move the device closer to this speaker or remove any obstacle between them.

Fail to find [Philips S7505] on your Bluetooth device for pairing

- Press and hold  for 2 seconds to enter Bluetooth pairing mode, and then try again.

Cannot connect with your Bluetooth device

- The Bluetooth function of your device is not enabled. Refer to the user manual of your device to find out how to enable the function.
- This speaker is not in pairing mode.
- This speaker is already connected to another Bluetooth-enabled device. Disconnect and try again.

7 Notice

Any changes or modifications made to this device that are not expressly approved by **MMD Hong Kong Holding Limited** may void the user's authority to operate the product.

Compliance



Hereby, **TP Vision Europe B.V.** declares that this product is in compliance with the essential requirements and other relevant provisions of Directive 2014/53/EU. You can find the Declaration of Conformity on www.philips.com/support.

Care of the environment

Disposal of your old product and battery



Your product is designed and manufactured with high quality materials and components, which can be recycled and reused.



This symbol on a product means that the product is covered by European Directive 2012/19/EU.



This symbol means that the product contains batteries covered by European Directive 2013/56/EU which cannot be disposed of with normal household waste.

Inform yourself about the local separate collection system for electrical and electronic products and batteries. Follow local rules and

never dispose of the product and batteries with normal household waste. Correct disposal of old products and batteries helps prevent negative consequences for the environment and human health.

Removing the disposal batteries

To remove the disposable batteries, see battery install section.

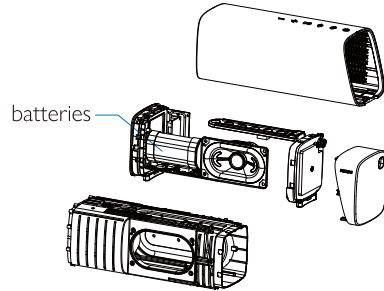

For INSPIRATION only

Environmental information

All unnecessary packaging has been omitted. We have tried to make the packaging easy to separate into three materials: cardboard (box), polystyrene foam (buffer) and polyethylene (bags, protective foam sheet.)

Your system consists of materials which can be recycled and reused if disassembled by a specialized company. Please observe the local regulations regarding the disposal of packaging materials, exhausted batteries and old equipment.

FCC Statement

This device complies with Part 15 of the FCC Rules. Operation is subject to the following two conditions: (1) This device may not cause harmful interference, and (2) This device must accept any interference received, including interference that may cause undesired operation.

Warning: Changes or modifications not expressly approved by the party responsible for compliance could void the user's authority to operate the equipment.

Note: This equipment has been tested and found to comply with the limits for a Class B digital device, pursuant to Part 15 of the FCC Rules.

These limits are designed to provide reasonable protection against harmful interference in a residential installation.

This equipment generates, uses and can radiate radio frequency energy and, if not installed and used in accordance with the instructions, may cause harmful interference to radio communications. However, there is no guarantee that interference will not occur in a particular installation. If this equipment does cause harmful interference to radio or television reception, which can be determined by turning the equipment off and on, the user is encouraged to try to correct the interference by one or more of the following measures: (1) Reorient or relocate the receiving antenna. (2) Increase the separation between the equipment and receiver. (3) Connect the equipment into an outlet on a circuit different from that to which the receiver is connected. (4) Consult the dealer or an experienced radio/TV technician for help.

RF Warning Statement

The device has been evaluated to meet general RF exposure requirements. The device can be used in portable exposure conditions without restriction.

Trademark notice



The Bluetooth® word mark and logos are registered trademarks owned by the Bluetooth SIG, Inc. and any use of such marks by **MMD Hong Kong Holding Limited** is under license. Other trademarks and trade names are those of their respective owners.



Modelo: WB-2835



Para maiores informações, consulte a site da ANATEL: www.anatel.gov.br
Este equipamento não tem direito à proteção contra interferência prejudicial e não pode causar interferência em sistemas devidamente autorizados.
“Este produto contém a placa WB-2835 código de homologação 17286-20-11794”

Specifications are subject to change without notice.
Philips and the Philips Shield Emblem are registered trademarks of Koninklijke Philips N.V. and are used under license.
This product has been manufactured by and is sold under the responsibility of MMD Hong Kong Holding Limited or one of its affiliates, and MMD Hong Kong Holding Limited is the warrantor in relation to this product.

TAS7505_00_UM_V1.0

